

DISCRETE DIFFERENTIAL  
GEOMETRY:  
AN APPLIED INTRODUCTION  
Keenan Crane • CMU 15-458/858

LECTURE 8:  
DISCRETE DIFFERENTIAL FORMS

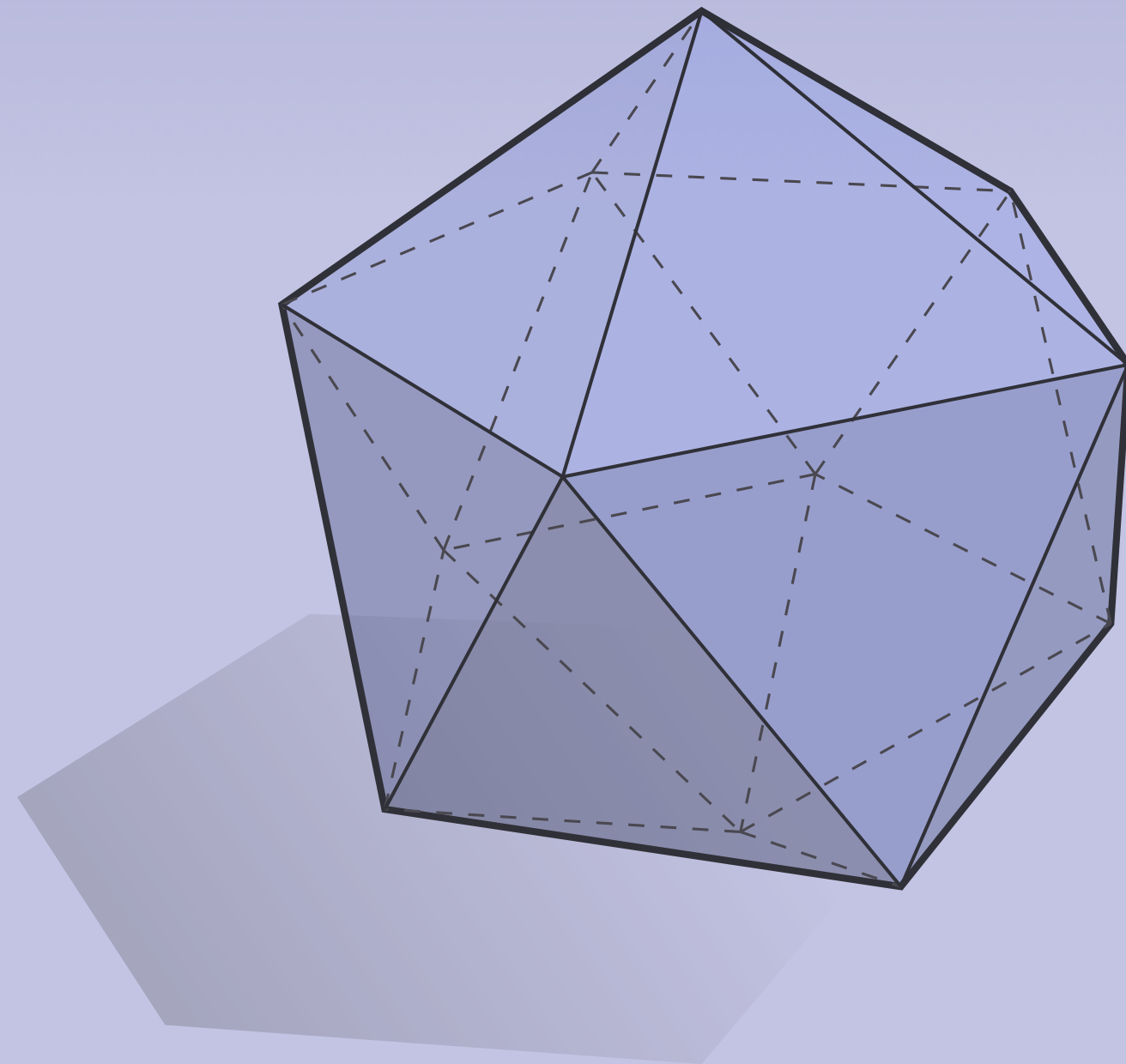

DISCRETE DIFFERENTIAL  
GEOMETRY:  
AN APPLIED INTRODUCTION

Keenan Crane • CMU 15-458/858

# Review—Exterior Calculus

- Last lecture we saw *exterior calculus* (differentiation & integration of forms)
- As a review, let's try *solving an equation* involving differential forms

**Given:** the 2-form  $\omega := dx \wedge dy$  on  $\mathbb{R}^2$

**Find:** a 1-form  $\alpha$  such that  $d\alpha = \omega$ .

Well, *any* 1-form on  $\mathbb{R}^2$  can be expressed as  $\alpha = udx + vdy$  for some pair of coordinate functions  $u, v : \mathbb{R}^2 \rightarrow \mathbb{R}$ .

We therefore want to find  $u, v$  such that  $du \wedge dx + dv \wedge dy = dx \wedge dy$ .

Recalling that  $dx \wedge dy = -dy \wedge dx$ , we must have  $v = \frac{1}{2}x$  and  $u = -\frac{1}{2}y$ .

In other words,  $\alpha = \frac{1}{2}(xdy - ydx)$ .

(...is that what you expected?)



# Discrete Exterior Calculus—Motivation

- Solving even *very easy* differential equations by hand can be hard!

- If equations involve data, *forget* about solving them by hand!

- Instead, need way to approximate solutions via computation

- **Basic idea:**

- replace domain with mesh

- replace differential forms with values on mesh

- replace differential operators with matrices

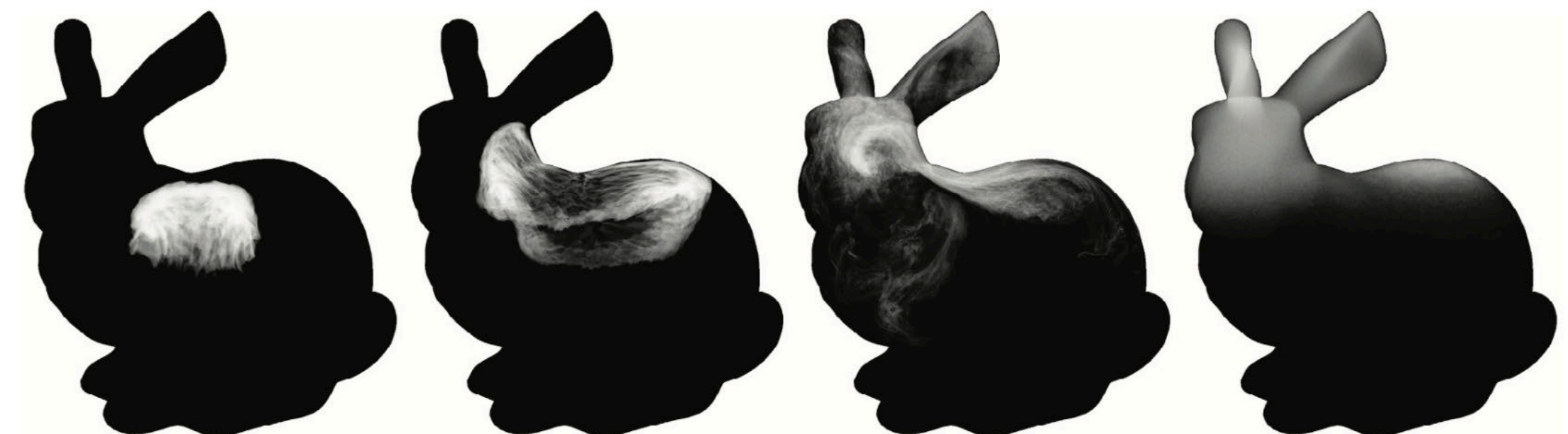
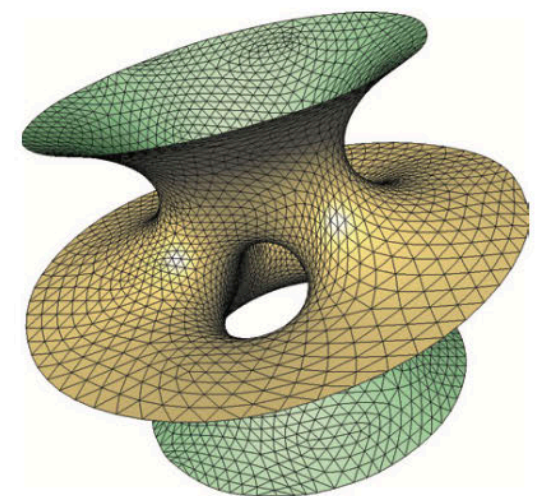
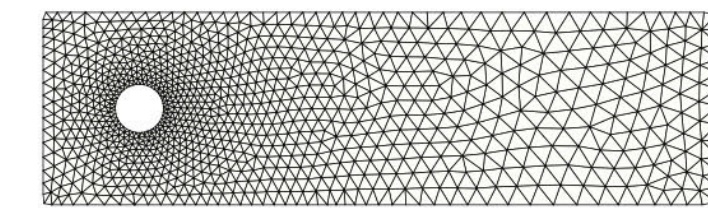
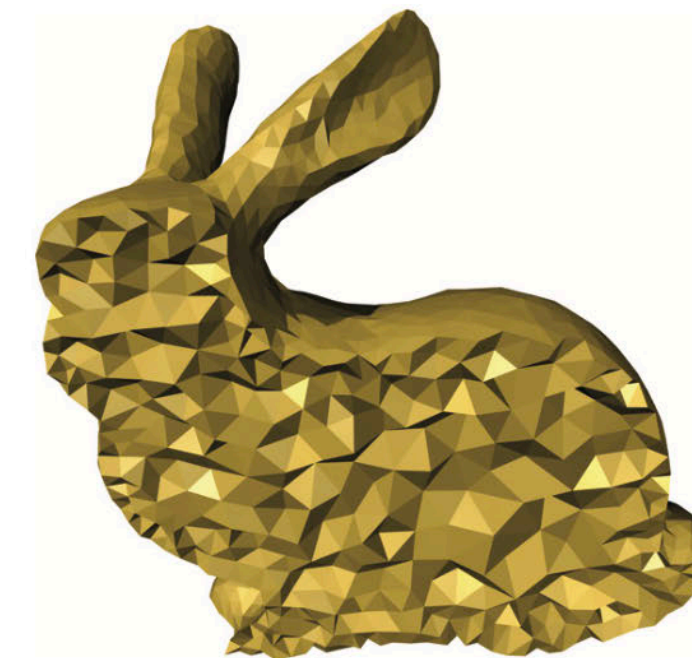
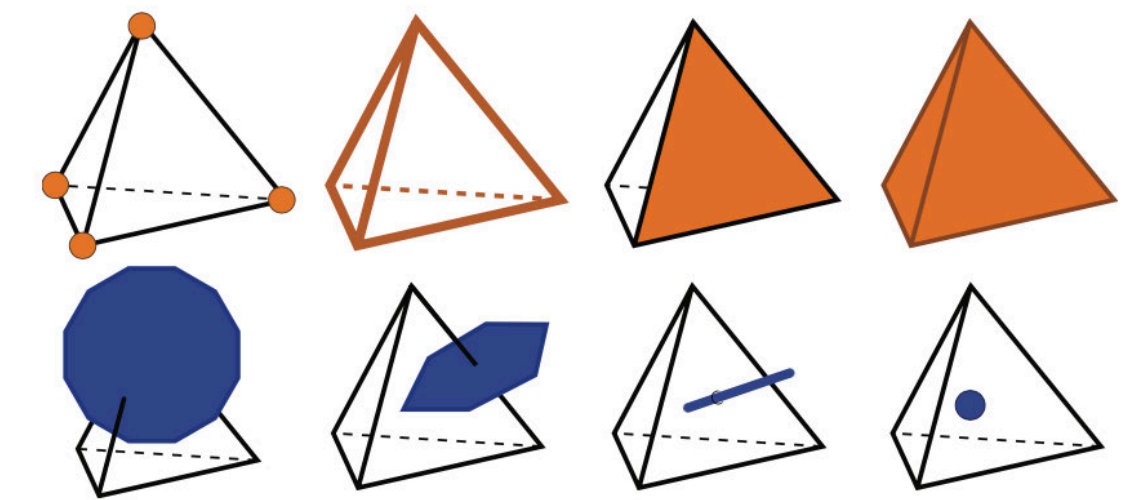

(pictures: Elcott et al, “Stable, Circulation-Preserving, Simplicial Fluids”)

# Discrete Exterior Calculus—Basic Operations

- In smooth exterior calculus, we saw many operations (wedge product, Hodge star, exterior derivative, sharp, flat, ...)
- For solving equations on meshes, the most basic operations are typically the **discrete exterior derivative** ( $d$ ) and the **discrete Hodge star** ( $\star$ ), which we'll ultimately encode as sparse matrices.

$$d\phi = \frac{\partial\phi}{\partial x^i} dx^i$$

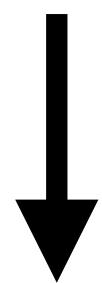

$$\begin{bmatrix} -1 & 1 & 0 & 0 \\ 0 & -1 & 1 & 0 \\ 1 & 0 & -1 & 0 \\ -1 & 0 & 0 & 1 \\ 0 & 0 & 1 & -1 \end{bmatrix} \begin{bmatrix} \phi_1 \\ \phi_2 \\ \phi_3 \\ \phi_4 \end{bmatrix}$$

$$\star(\alpha_1 dx^1 + \alpha_2 dx^2) = -\alpha_2 dx^1 + \alpha_1 dx^2$$

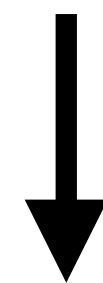

$$\begin{bmatrix} w_1 & 0 & 0 & 0 & 0 \\ 0 & w_2 & 0 & 0 & 0 \\ 0 & 0 & w_3 & 0 & 0 \\ 0 & 0 & 0 & w_4 & 0 \\ 0 & 0 & 0 & 0 & w_5 \end{bmatrix} \begin{bmatrix} \alpha_1 \\ \alpha_2 \\ \alpha_3 \\ \alpha_4 \\ \alpha_5 \end{bmatrix}$$

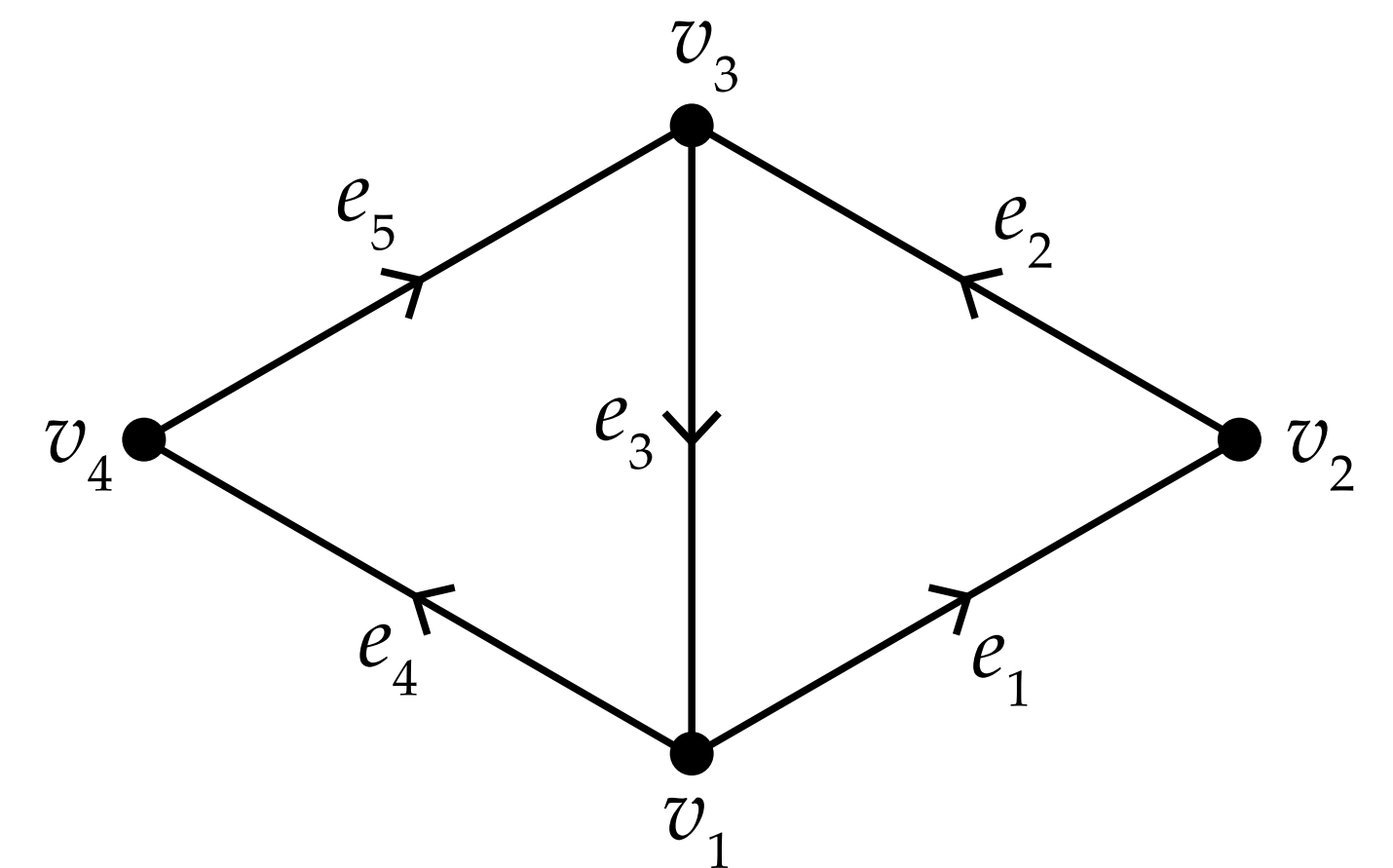



# Composition of Operators

- By composing matrices, we can easily solve equations involving operators like those from vector calculus (grad, curl, div, Laplacian...) but in much greater generality (e.g., curved surfaces, k-forms...) and on complicated domains (meshes)

$$\text{grad} \longrightarrow d_0$$

$$\text{curl} \longrightarrow \star_2 d_1$$

$$\text{div} \longrightarrow \star_0^{-1} d_0^T \star_1$$

$$\Delta \longrightarrow \star_0^{-1} d_0^T \star_1 d_0$$

$$\Delta_k \longrightarrow d_{k-1} \star_{k-1}^{-1} d_{k-1}^T \star_k + \star_k^{-1} d_k^T \star_{k+1} d_k$$

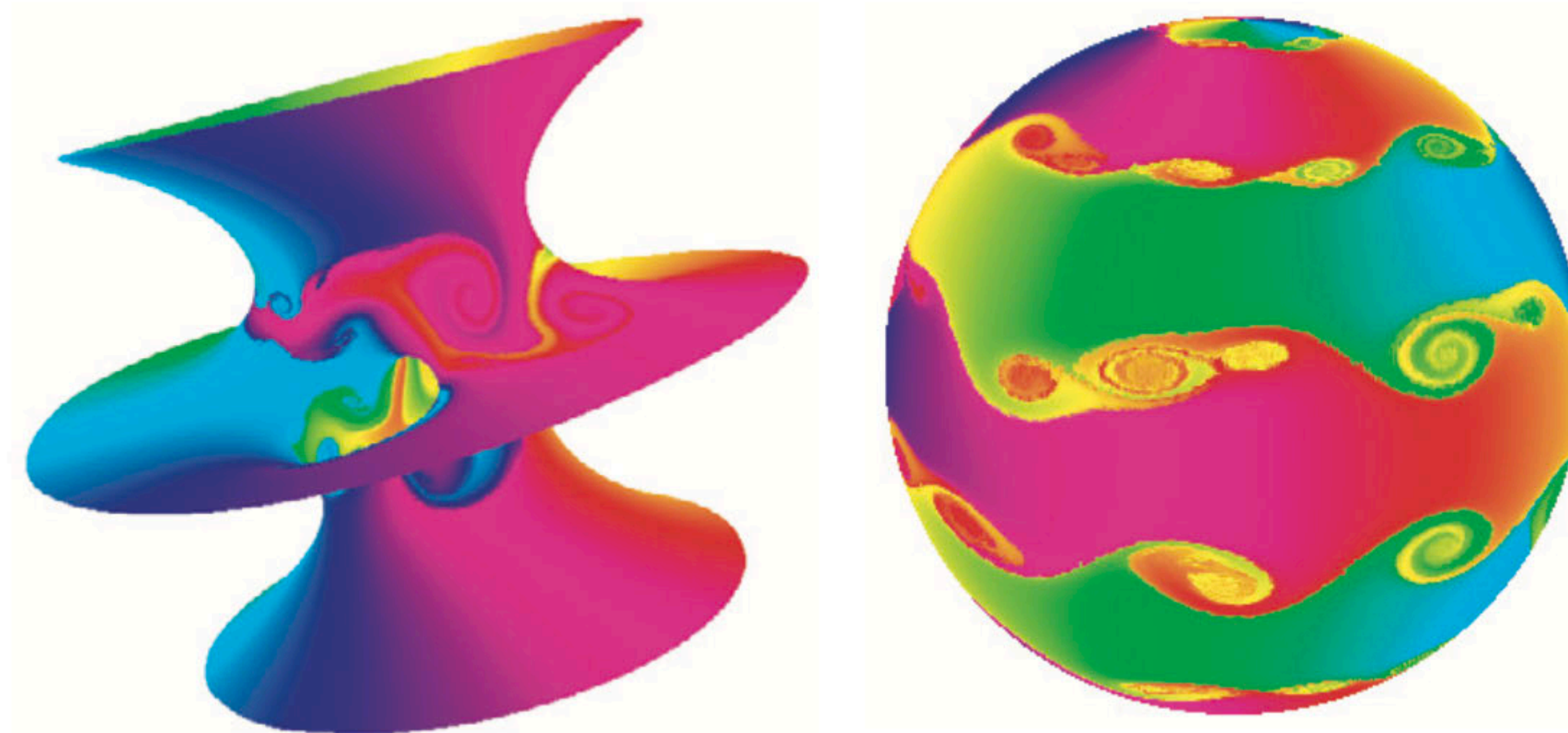

**Basic recipe:** load a mesh, build a few basic matrices, solve a linear system.

# Discretization & Interpolation

- Two basic operations needed to translate between smooth & discrete quantities:
  - **Discretization** — given a continuous object, how do I turn it into a finite (or *discrete*) collection of measurements?
  - **Interpolation** — given a discrete object (representing a finite collection of measurements), how do I come up with a continuous object that agrees with (or *interpolates*) it?

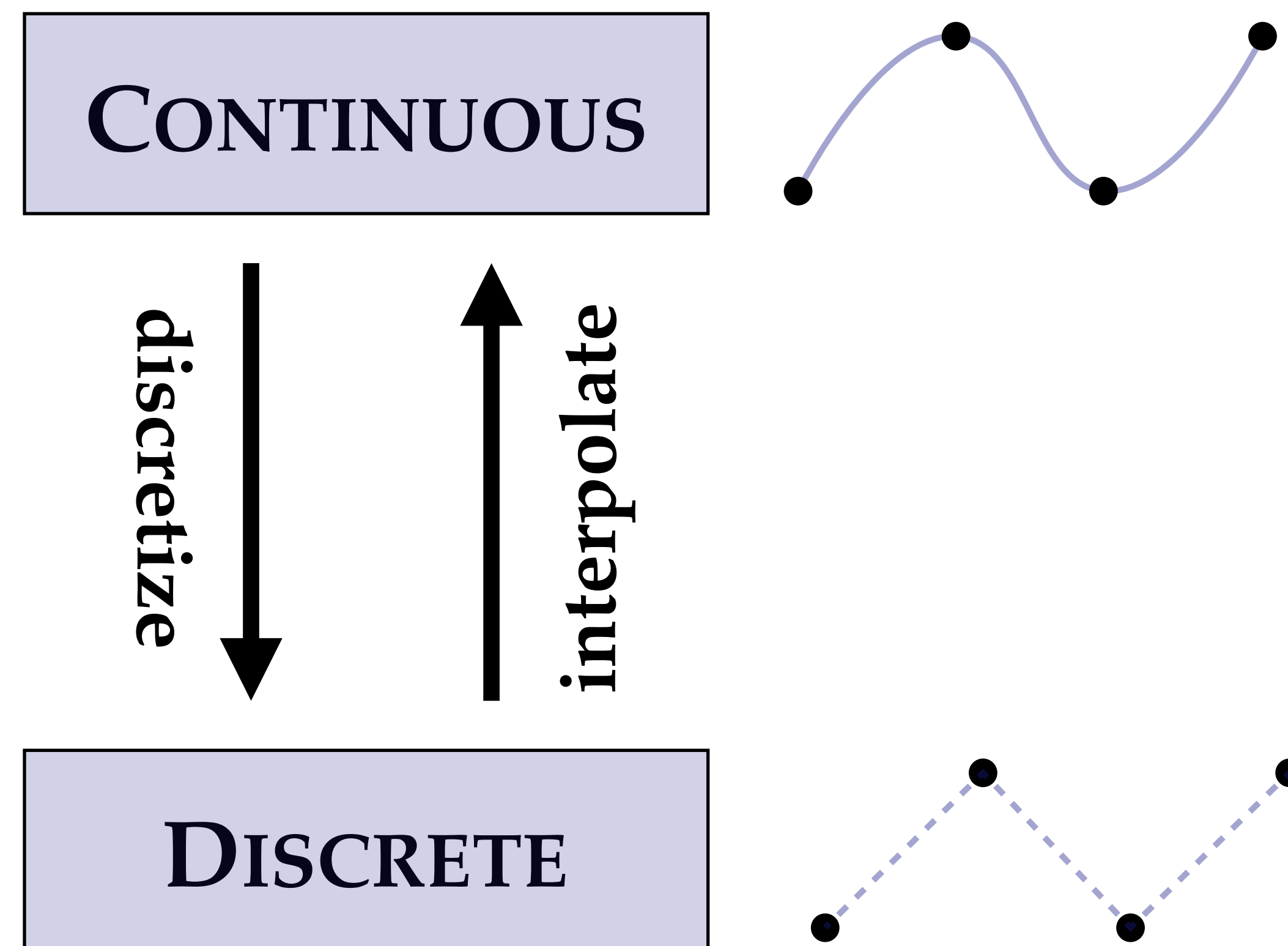

# Discretization & Interpolation – Differential Forms

- In the particular case of a differential  $k$ -form:
  - **Discretization** happens via *integration* over oriented  $k$ -simplices (known as the *de Rham map*)
  - **Interpolation** is performed by taking linear combinations of continuous functions associated with  $k$ -simplices (known as *Whitney interpolation*)
- With these operations, becomes easy to translate some pretty sophisticated equations into algorithms!

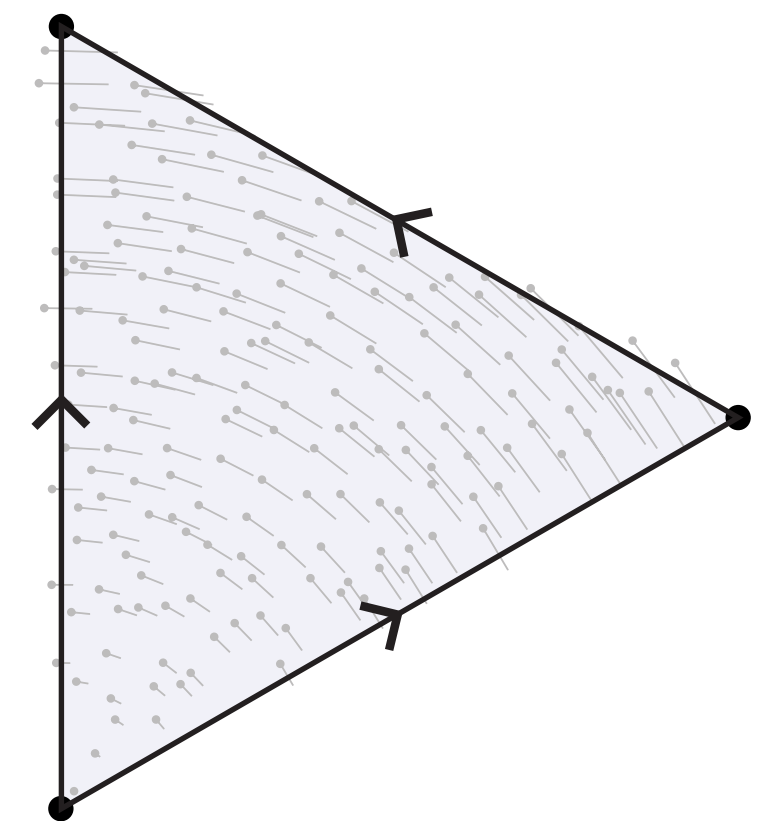
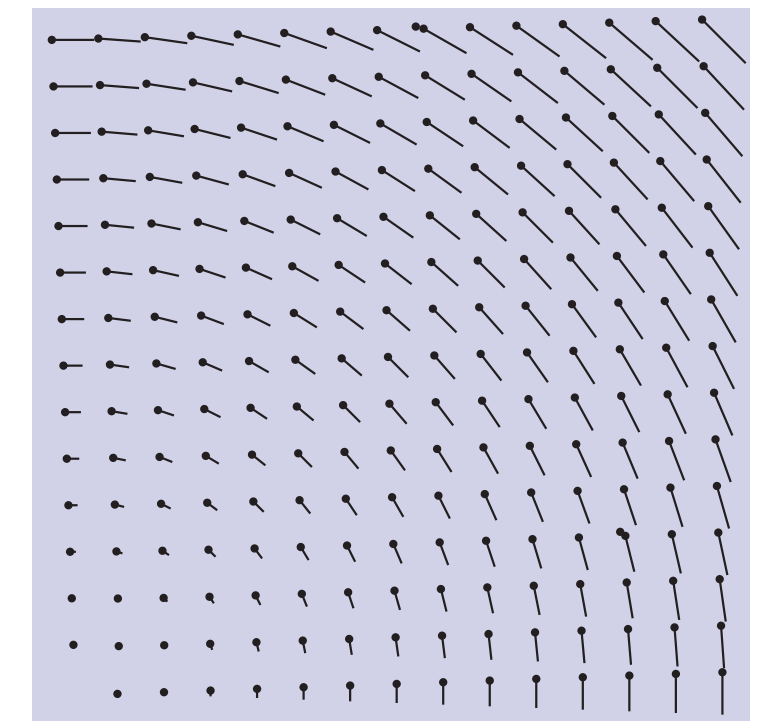
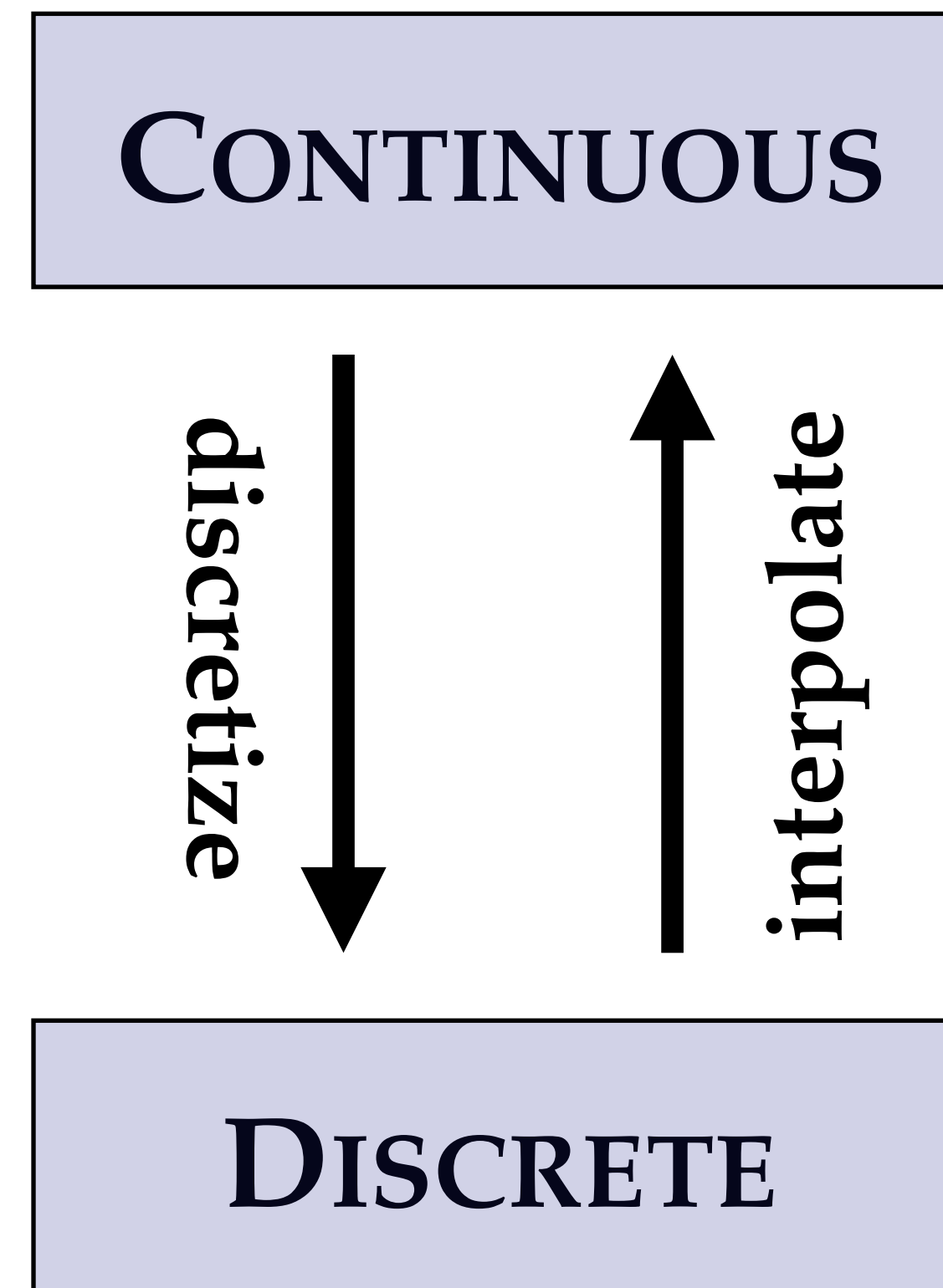





*Discretization*

# Discretization — Basic Idea

Given a continuous differential form, how can we approximate it on a mesh?

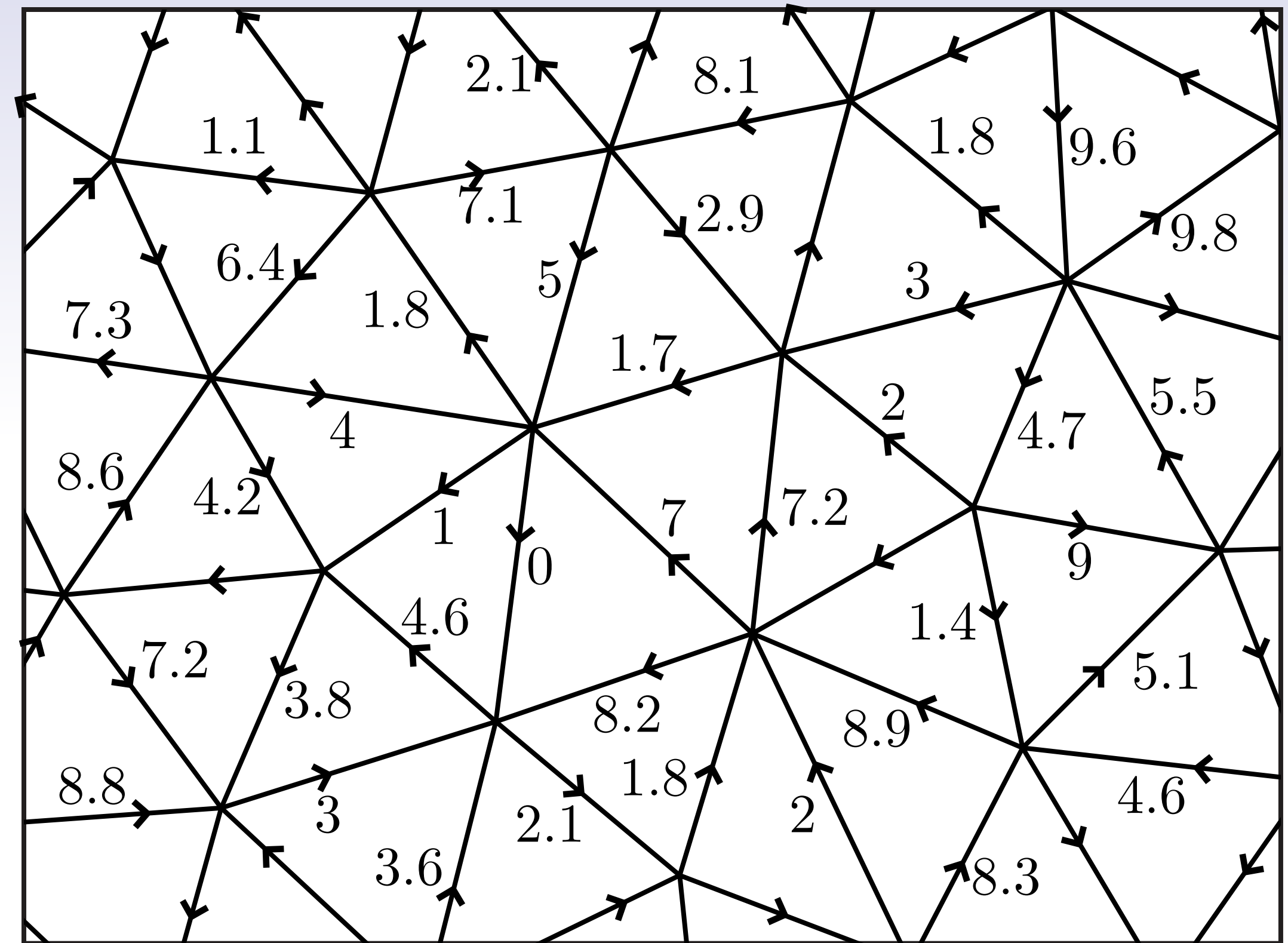
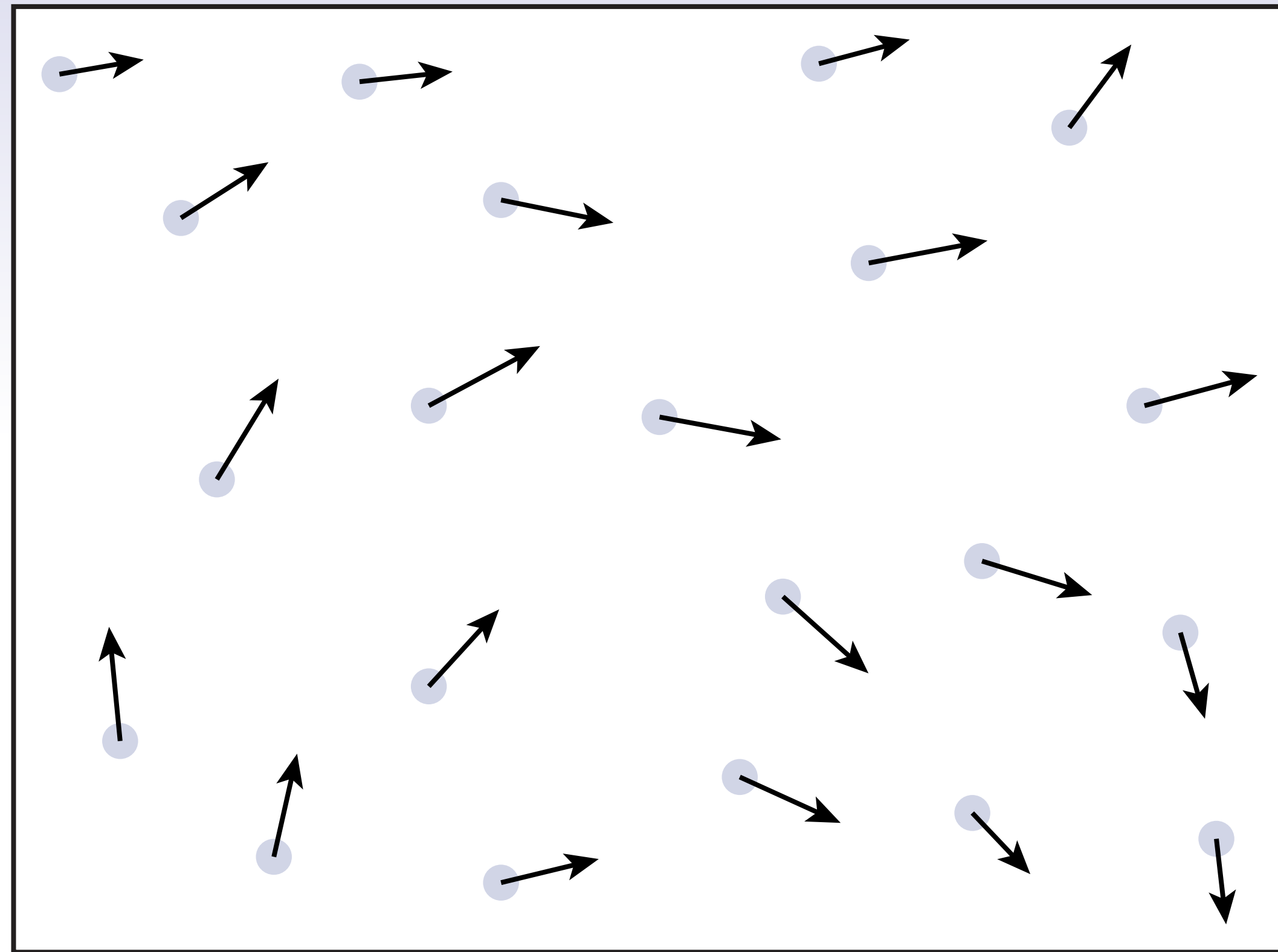

**Basic idea:** integrate  $k$ -forms over  $k$ -simplices.

Doesn't tell us *everything* about the form... but enough to solve interesting equations!

# Discretization of Forms (de Rham Map)

Let  $K$  be an oriented simplicial complex on  $\mathbb{R}^n$ , and let  $\omega$  be a differential  $k$ -form on  $\mathbb{R}^n$ . For each simplex  $\sigma \in K$ , the corresponding value of the discrete  $k$ -form  $\hat{\omega}$  is given by

$$\hat{\omega}_\sigma := \int_\sigma \omega$$

The map from continuous forms to discrete forms is called the *discretization map*, or sometimes the *de Rham map*.

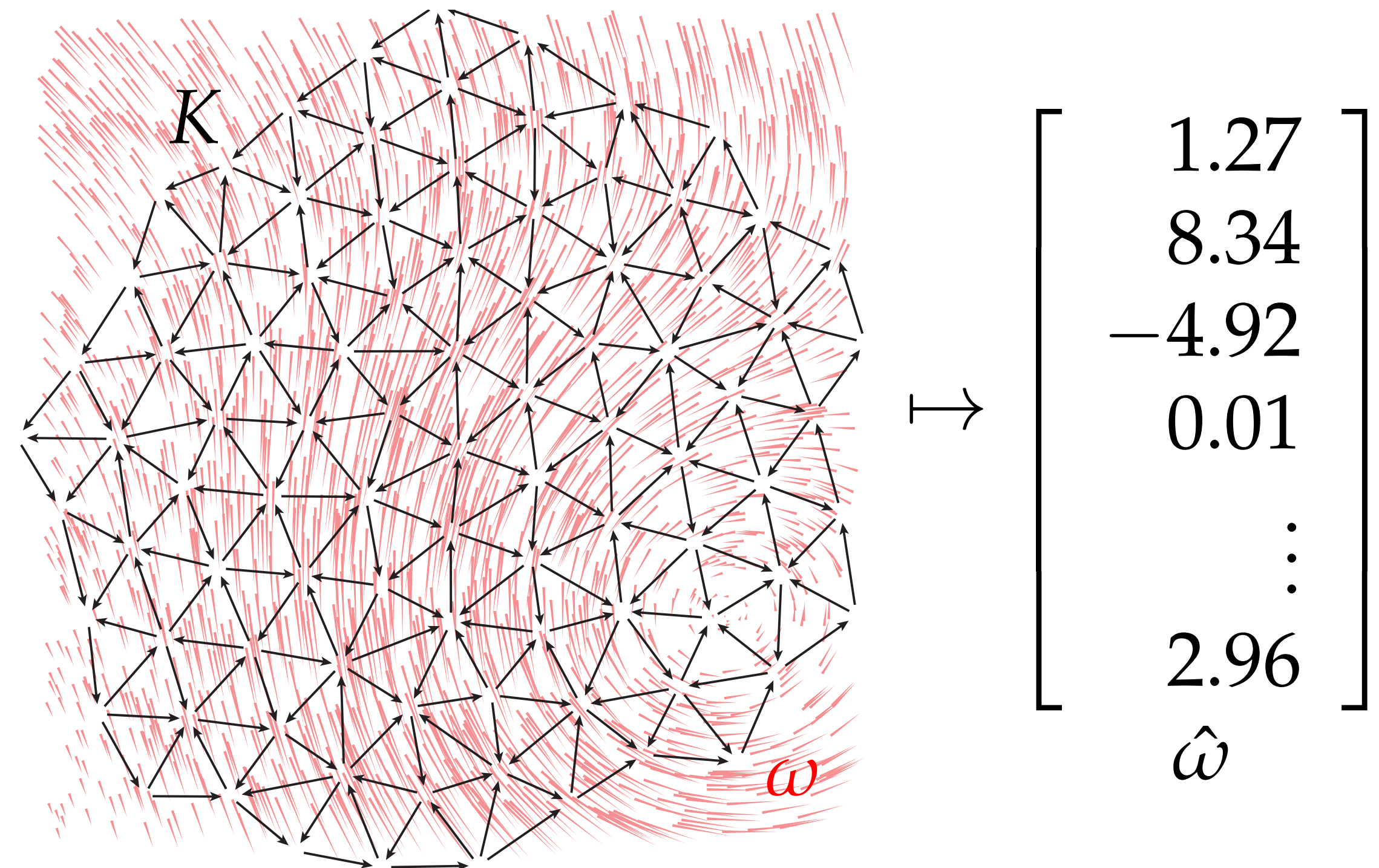

**Key idea:** *discretization* just means “integrate a  $k$ -form over  $k$ -simplices.”  
Result is just a list of values.



# Integrating a 0-form over Vertices

- Suppose we have a 0-form  $\phi$
- What does it mean to integrate it over a vertex  $v$ ?
- Easy: just take the value of the function at the location  $p$  of the vertex!

## Example:

$$\phi(x, y) := x^2 + y^2 + \cos(4(x + y))$$

$$p = (1, -1)$$

$$\int_v \phi = \phi(p) = 1 + 1 + \cos(0) = 3$$

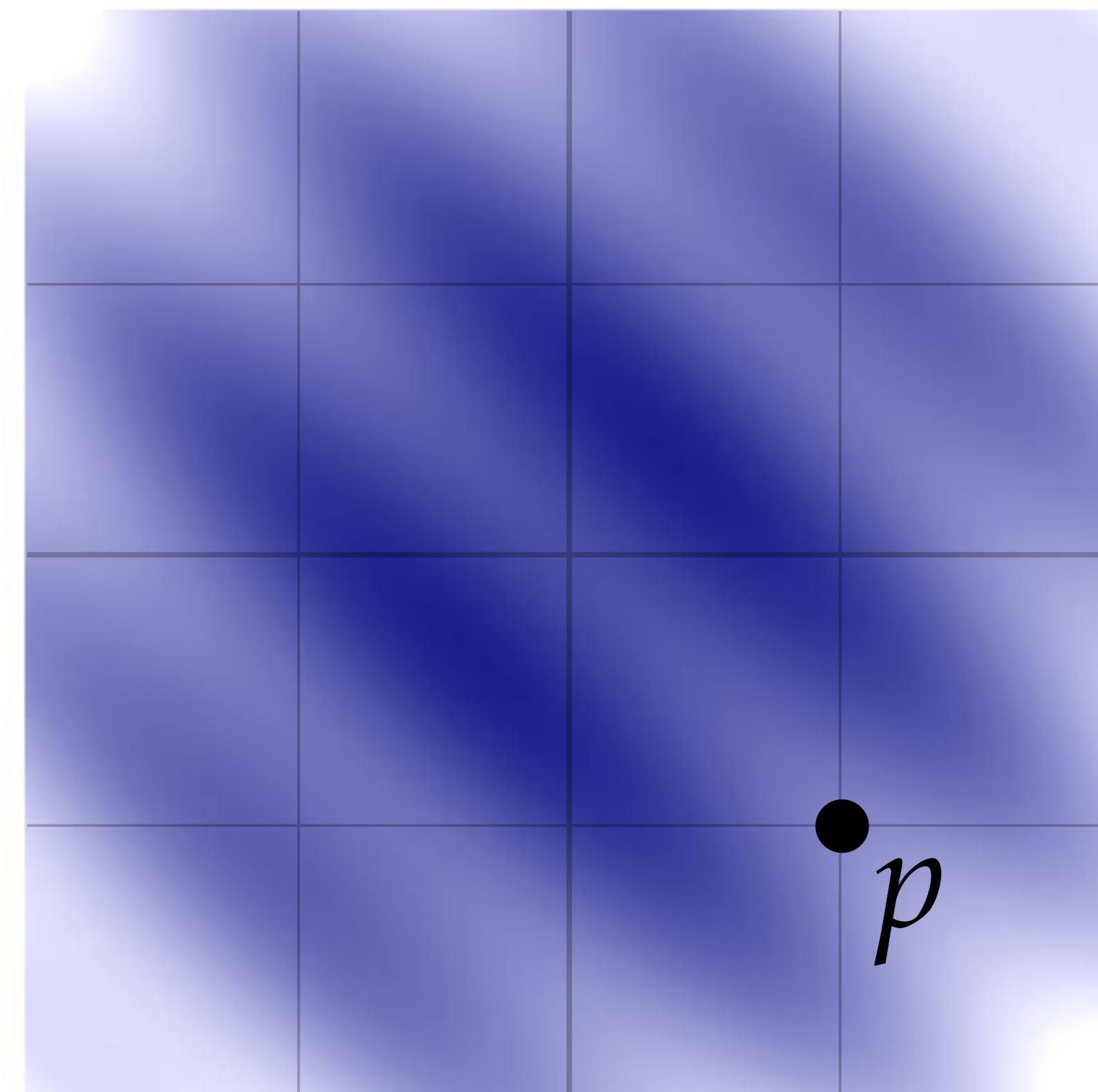

**Key idea:** integrating a 0-form at vertices of a mesh just “samples” the function

# Integrating a 1-form over an Edge

- Suppose we have a 1-form  $\alpha$  in the plane
- How do we integrate it over an edge  $e$ ?
- **Basic recipe:**
  - Compute unit tangent  $T$
  - Apply  $\alpha$  to  $T$ , yielding function  $\alpha(T)$
  - Integrate this scalar function over edge
- Result gives “total circulation”
- Can use *numerical quadrature* for tough integrals
  - In practice, rare to actually integrate!
  - More often, discrete 1-form values come from, e.g., operations on discrete 0-form

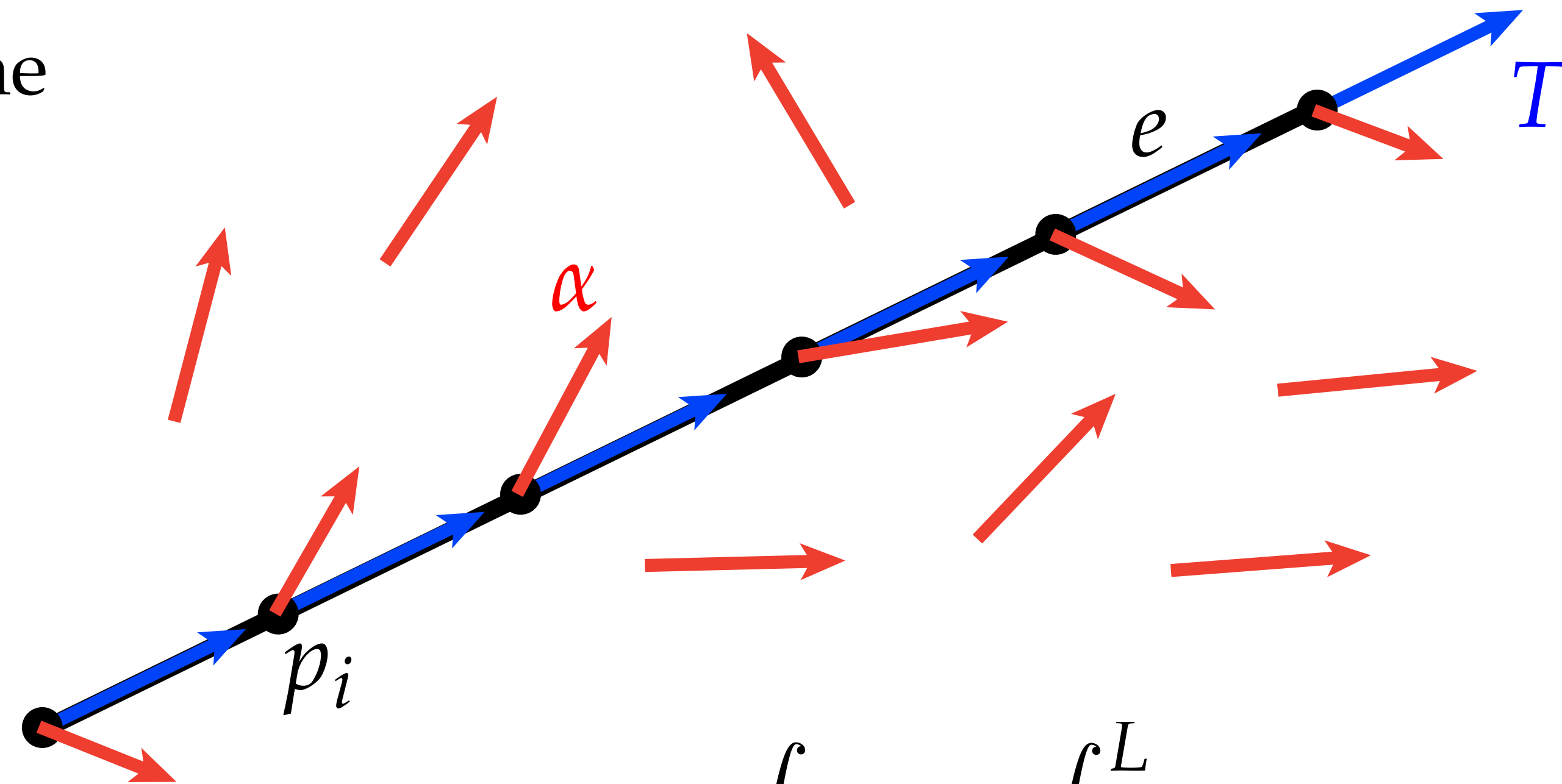

$$\hat{\alpha}_e := \int_e \alpha = \int_0^L \alpha(T) ds$$

$$\int_e \alpha \approx \text{length}(e) \left( \frac{1}{N} \sum_{i=1}^N \alpha_{p_i}(T) \right)$$

# Integrating a 1-Form over an Edge—Example

In  $\mathbb{R}^2$ , consider a 1-form  $\alpha := xydx - x^2dy$   
and an edge  $e$  with endpoints  $p_0 := (-1, 2)$   
 $p_1 := (3, 1)$

**Q:** What is  $\int_e \alpha$ ?

**A:** Let's first compute the edge length  $L$  and unit tangent  $T$ :

$$L := |p_1 - p_0| = \sqrt{17} \quad T := (p_1 - p_0)/L = (4, -1)/\sqrt{17}$$

Hence,  $\alpha(T) = (4xy + x^2)/\sqrt{17}$ .

An arc-length parameterization of the edge is given by

$$p(s) := p_0 + \frac{s}{L}(p_1 - p_0), \quad s \in [0, L]$$

By plugging in all these expressions/values, our integral simplifies to

$$\int_0^L \alpha(T)_{p(s)} ds = \frac{7}{17} \int_0^L (4s - L) ds = 7$$

...why not let  $T := (p_0 - p_1)/L$ ?

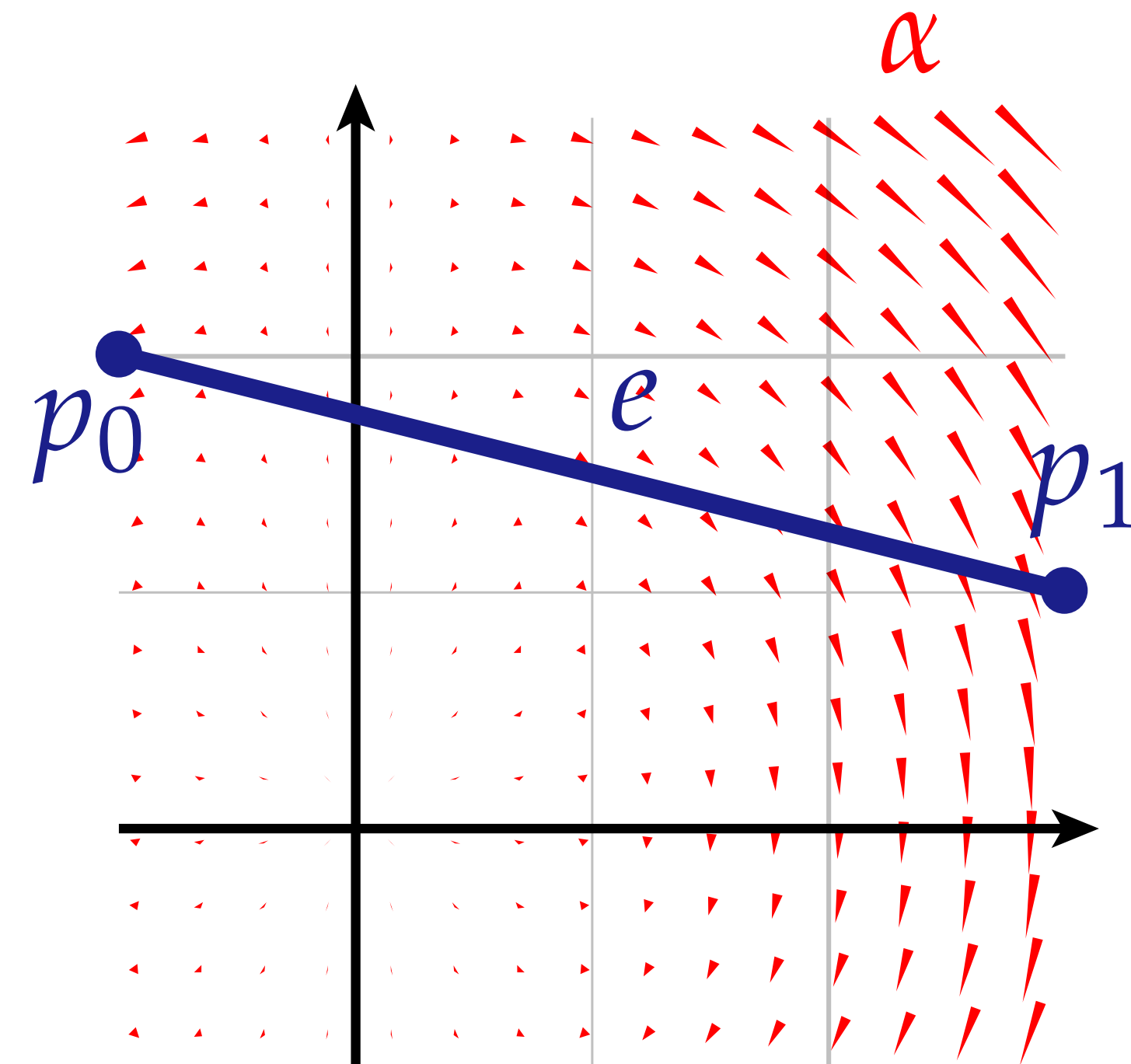



# Orientation & Integration

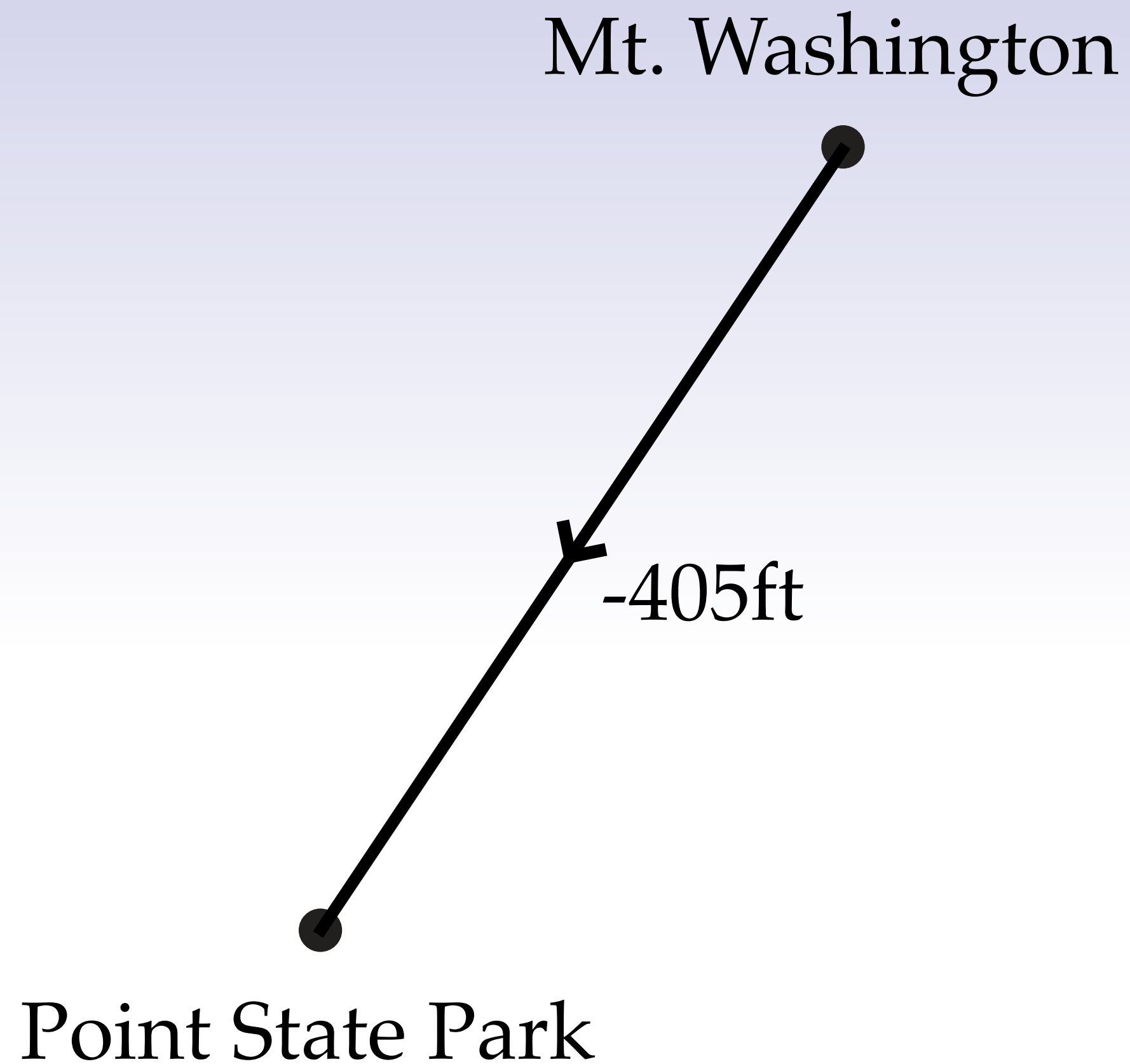
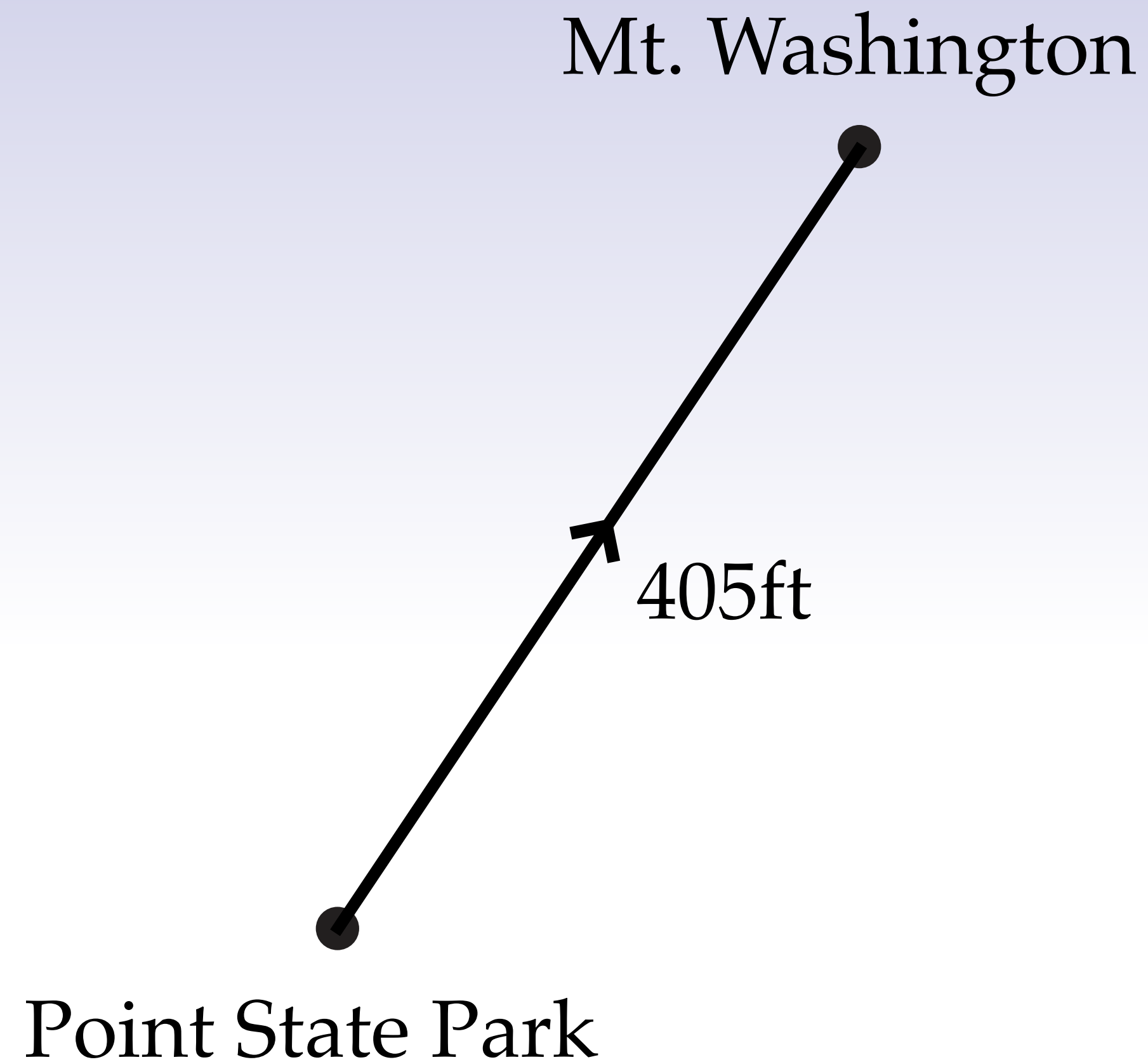

$$\int_a^b \frac{\partial \phi}{\partial x} dx = \phi(b) - \phi(a) = -(\phi(a) - \phi(b)) = - \int_b^a \frac{\partial \phi}{\partial x} dx$$

# Discretizing a 1-form — Example

**Example.** Let  $M$  be the unit square  $[0, 1]^2$  with a complex  $K$  embedded as shown on the right. Using  $x, y$  to denote coordinates on  $M$ , the 1-form  $\omega := 2dx$  is discretized by integrating over each edge:

$$\hat{\omega}_1 = \int_{e_1} \omega = \int_0^1 \omega \left( \frac{\partial}{\partial x} \right) d\ell = \int_0^1 2 d\ell = 2.$$

$$\hat{\omega}_2 = \int_{e_2} \omega = \int_0^1 \omega \left( \frac{\partial}{\partial y} \right) d\ell = \int_0^1 0 d\ell = 0.$$

$$\hat{\omega}_3 = \int_{e_3} \omega = \int_0^{\sqrt{2}} \omega \left( \frac{1}{\sqrt{2}} \left( \frac{\partial}{\partial x} + \frac{\partial}{\partial y} \right) \right) d\ell = \int_0^{\sqrt{2}} \frac{2}{\sqrt{2}} d\ell = 2.$$

$$\dots = \dots$$

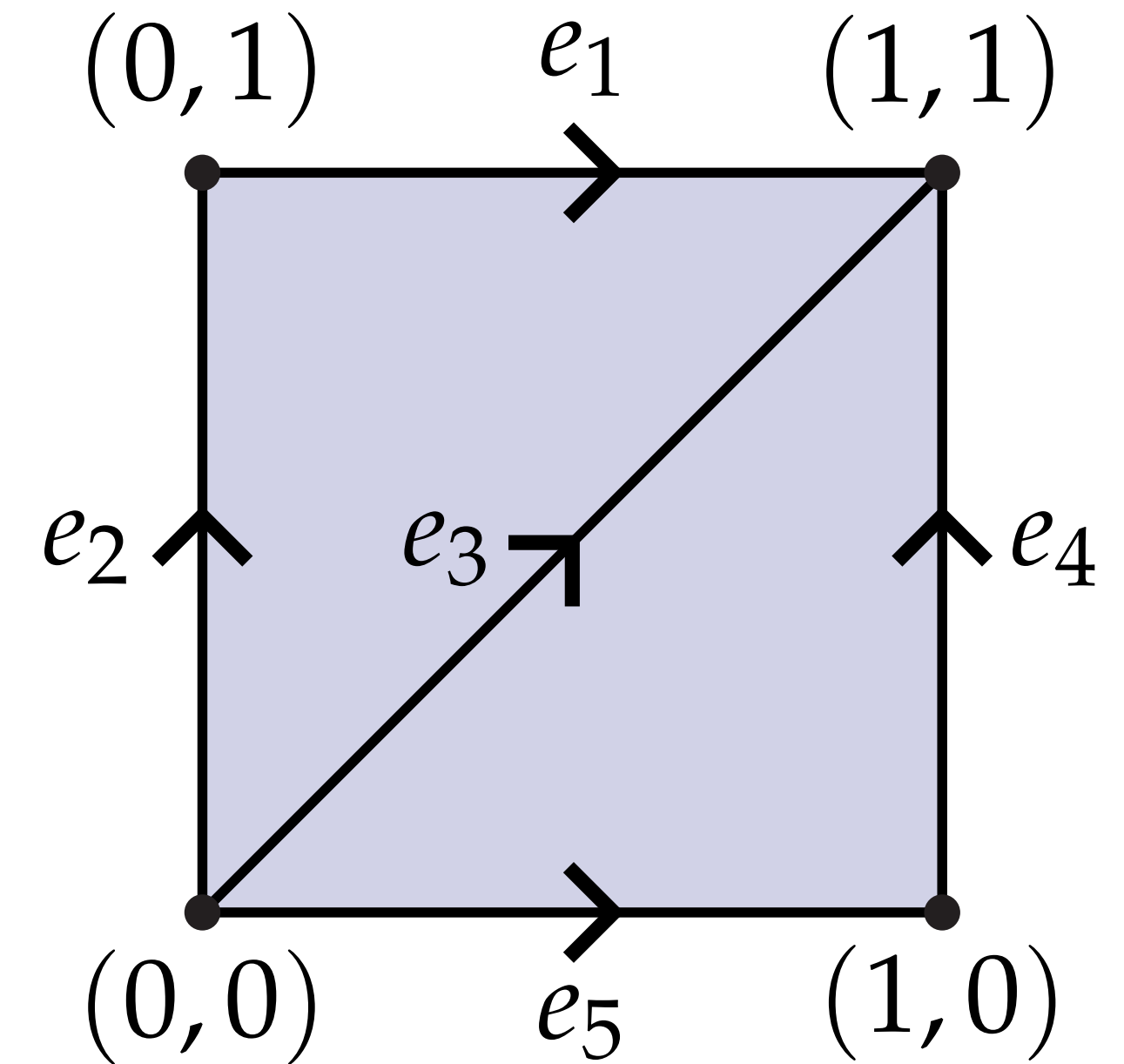

**Question:** Why does  $\hat{\omega}_1 = \hat{\omega}_3$ ?

# Integrating a 2-form Over a Triangle

- Suppose we have a 2-form  $\omega$  in  $R^3$
- How do we integrate it over a triangle  $t$ ?
- Similar recipe to 1-form:
  - Compute orthonormal basis  $T_1, T_2$  for triangle
  - Apply  $\omega$  to  $T_1, T_2$ , yielding a function  $\omega(T_1, T_2)$
  - Integrate this scalar function over triangle
- Value encodes how well triangle is “lined up” with 2-form on average, times area of triangle
- Again, rare to actually integrate explicitly!

**Q:** Here, what determines the *orientation* of  $t$ ?

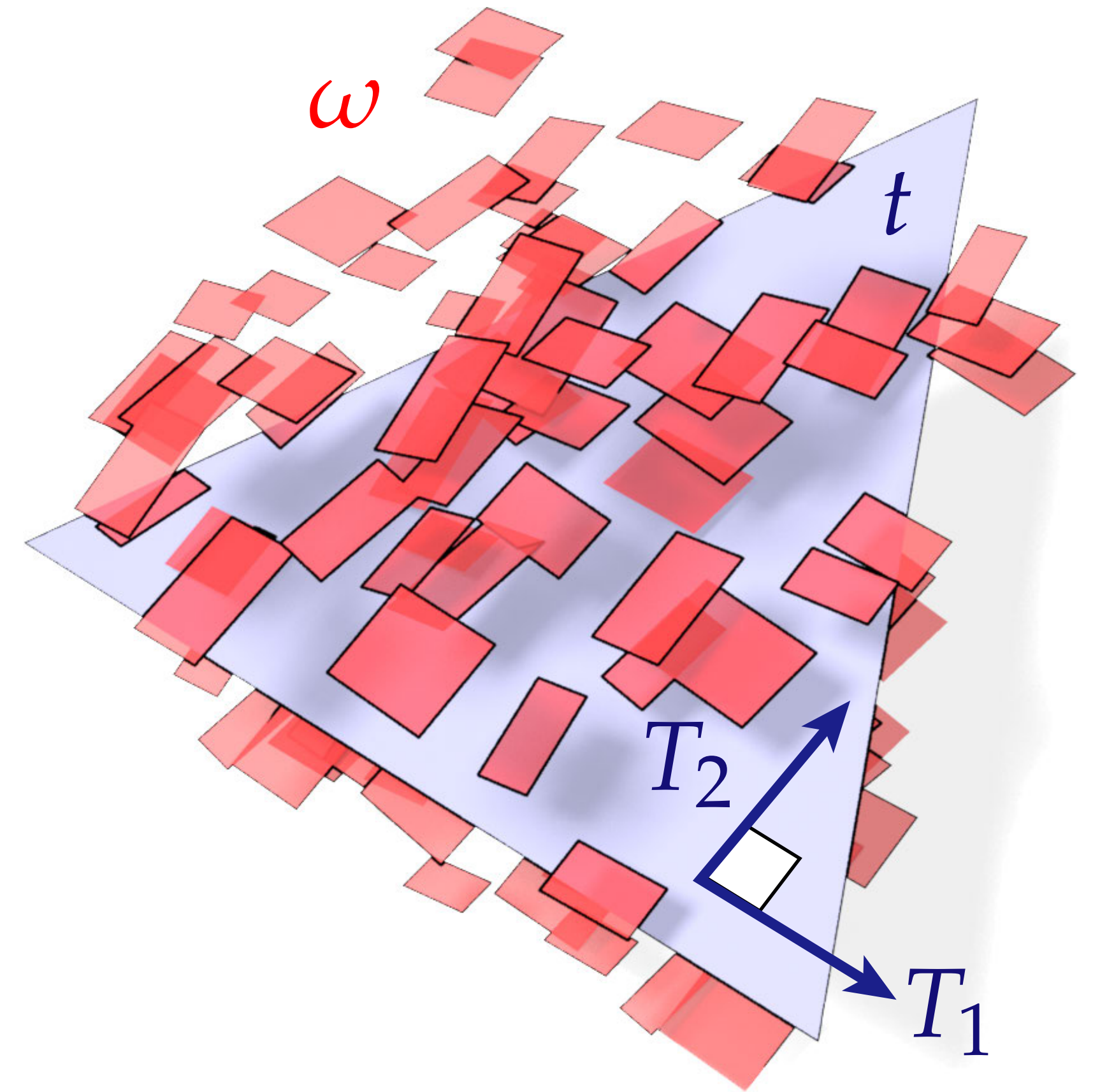

$$\int_t \omega \approx \text{area}(t) \left( \frac{1}{N} \sum_{i=1}^N \omega_{p_i}(T_1, T_2) \right)$$



# Orientation and Integration

- In general, reversing the **orientation** of a simplex will reverse the **sign** of the integral.
- E.g., suppose we have a discrete 1-form  $\alpha$ . Then for each edge  $ij$ ,

$$\alpha_{ij} = -\alpha_{ji}$$

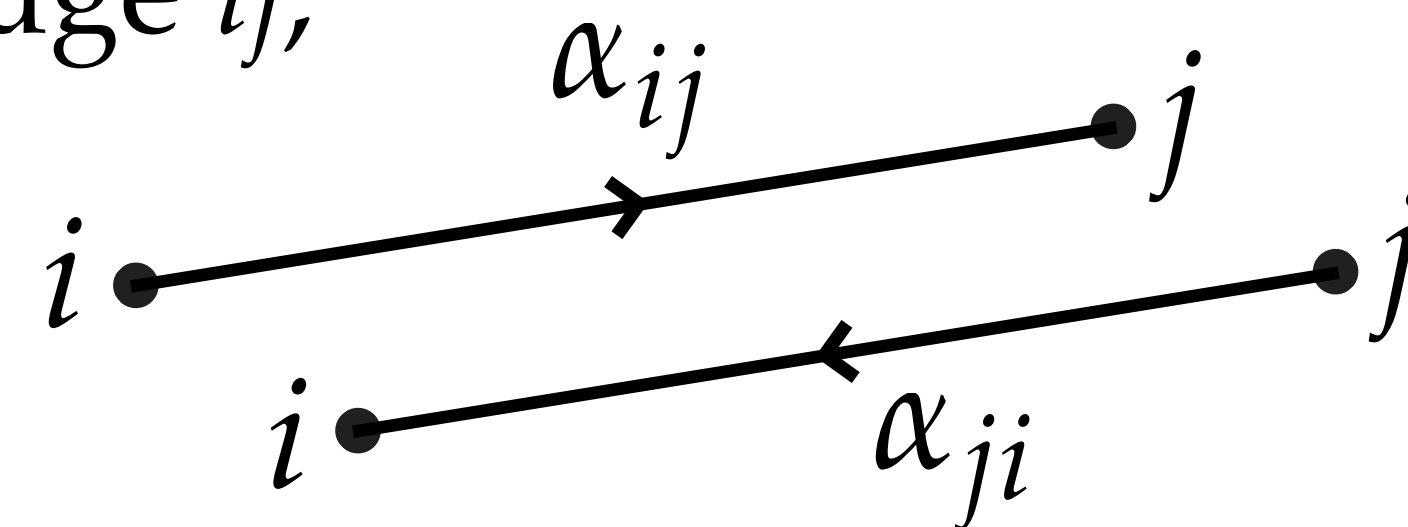

- **Q:** Suppose we have a 2-form  $\beta$ . What do you think the relationship is between...

$$\beta_{ijk} = \beta_{jki}$$

$$\beta_{jik} = -\beta_{kij}$$

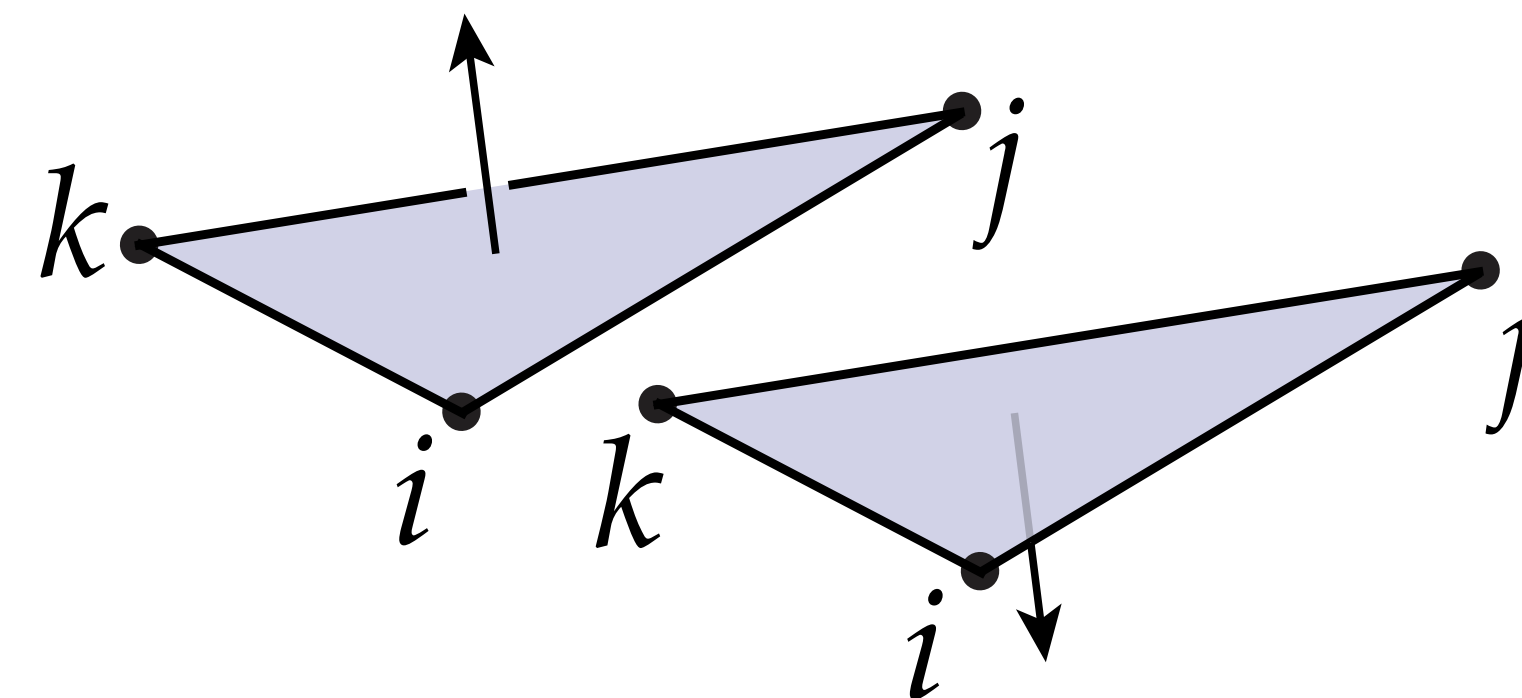

- **Q:** What's the rule in general?

- **A:** Discrete  $k$ -form values change sign under odd permutation. (Sound familiar? :-))



*Discrete Differential Forms*

# Discrete Differential $k$ -Form

- Abstractly, a *discrete differential  $k$ -form* is just any assignment of a value to each oriented  $k$ -simplex.
- For instance, in 2D:
  - values at **vertices** encode a discrete **0-form**
  - values at **edges** encode a discrete **1-form**
  - values at **faces** encode a discrete **2-form**
- *Conceptually*, values represent integrated  $k$ -forms
- *In practice*, almost never comes from direct integration!
- More typically, values start at vertices (samples of some function); 1-forms, 2-forms, *etc.*, arise from applying operators like the (discrete) exterior derivative

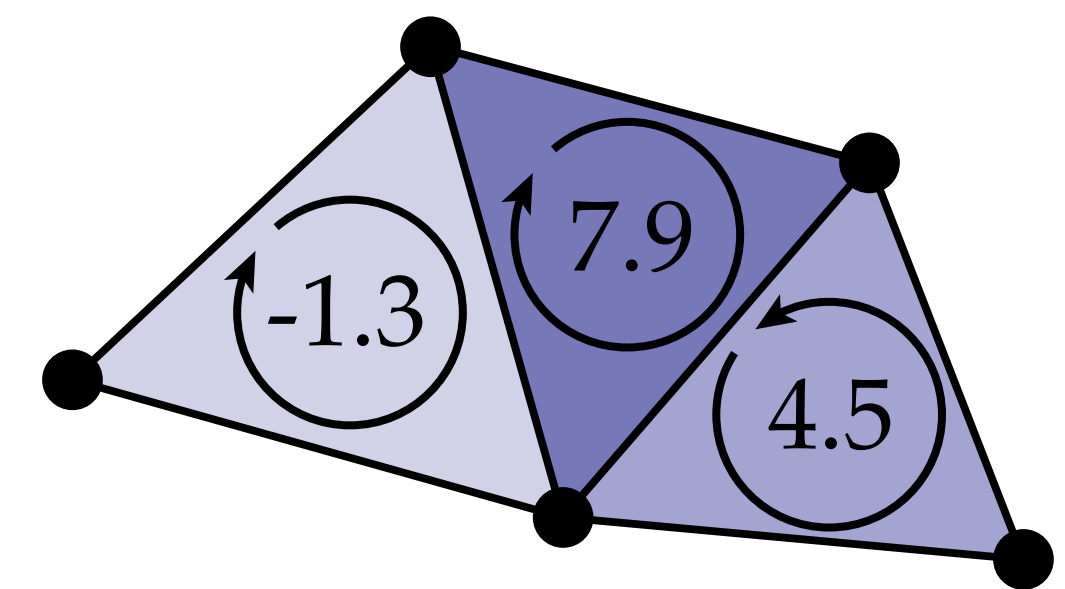
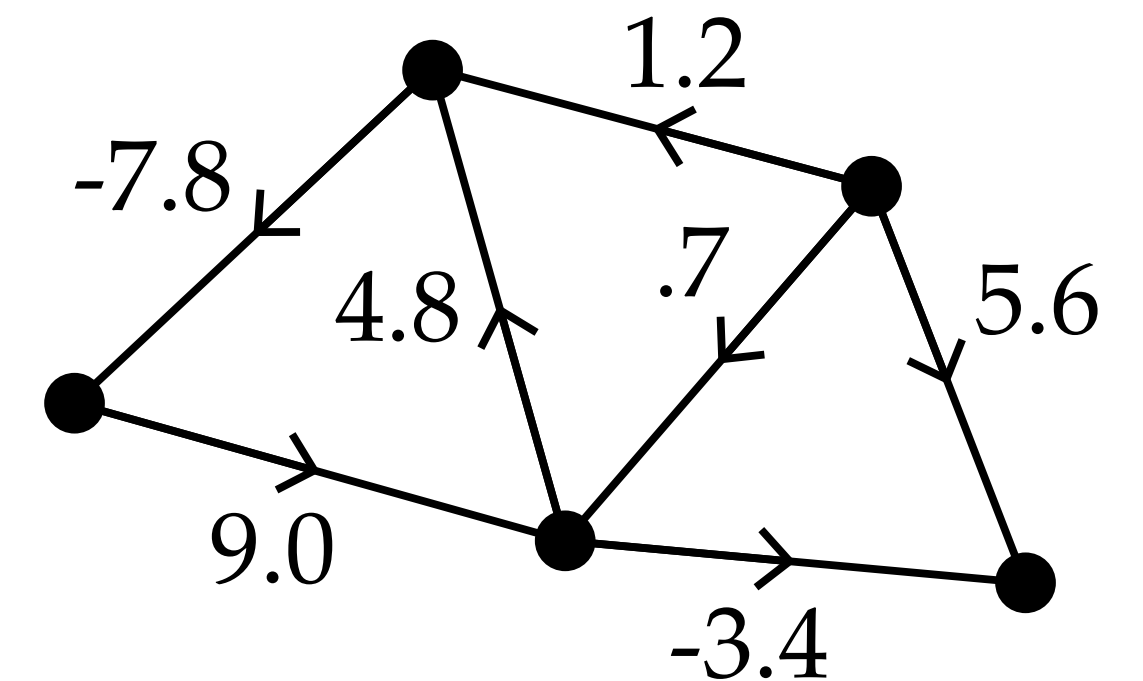
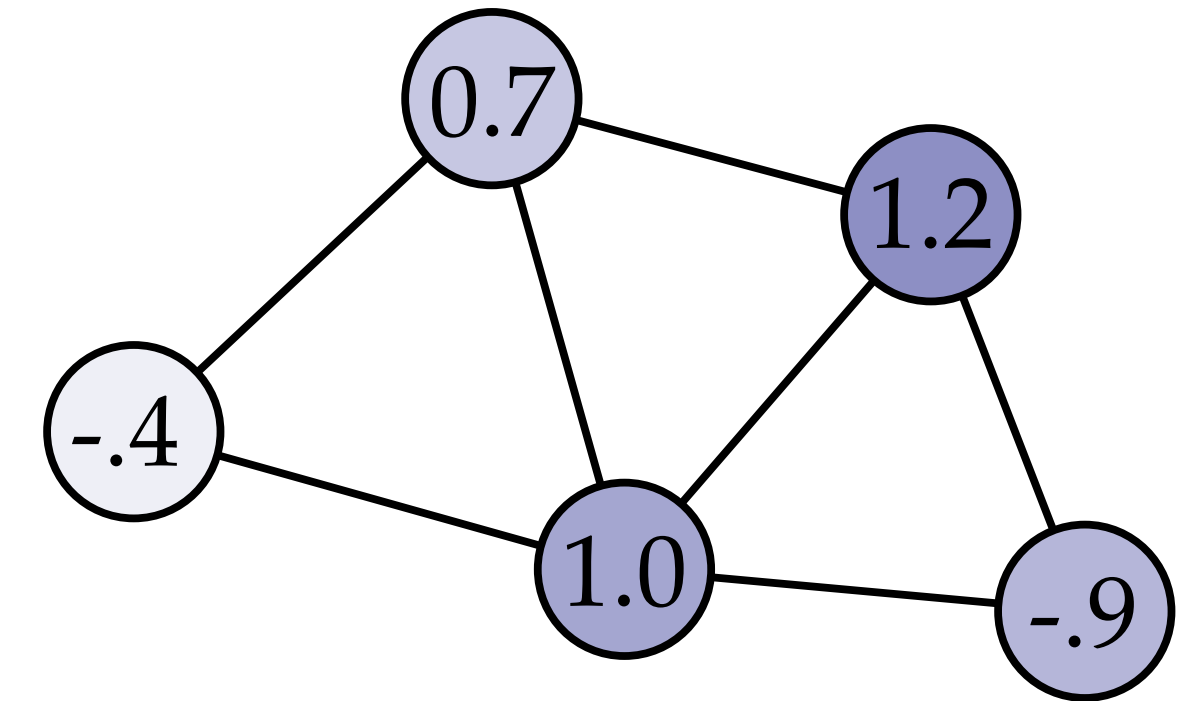



# Matrix Encoding of Discrete Differential $k$ -Forms

- We can encode a discrete  $k$ -form as a column vector with one entry for every  $k$ -simplex.
- To do so, we need to first assign a unique *index* to each  $k$ -simplex
  - The order of these indices can be completely arbitrary
  - We just need some way to put elements of our mesh into correspondence with entries of the vector
- Simplest example: a discrete 0-form can be encoded as a vector with  $|V|$  entries

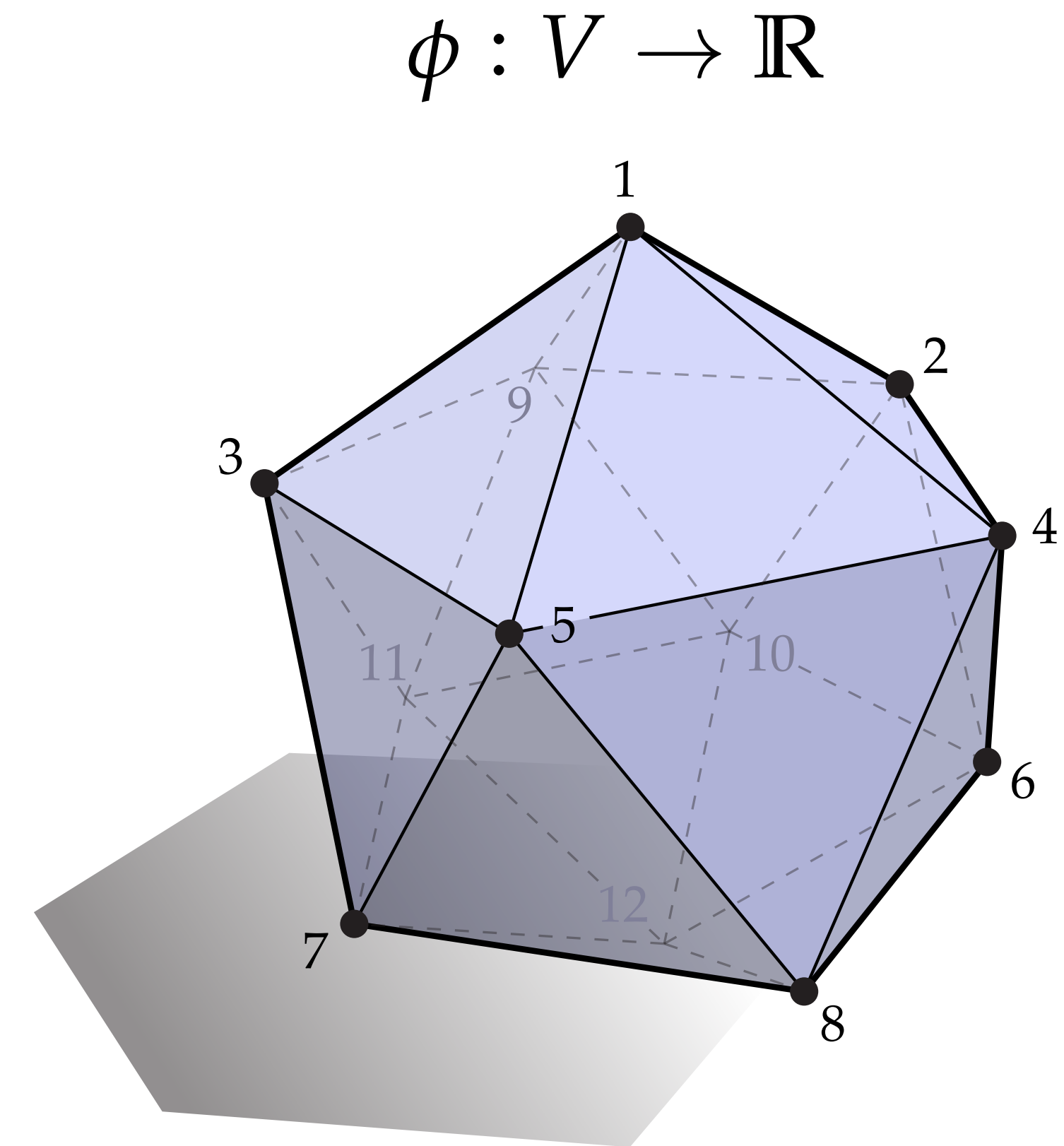

$$\phi = \begin{bmatrix} \phi_1 & \cdots & \phi_{|V|} \end{bmatrix}$$

**Careful:** In code, indices often start from 0 rather than 1!

# Matrix Encoding of Discrete Differential 1-Form

- A discrete differential 1-form is a value per edge of an oriented simplicial complex.
- To encode these values as a column vector, we must first assign a unique index to each edge of our complex.
- If we then have values on edges, we know how to assign them to entries of the vector encoding the discrete 1-form.

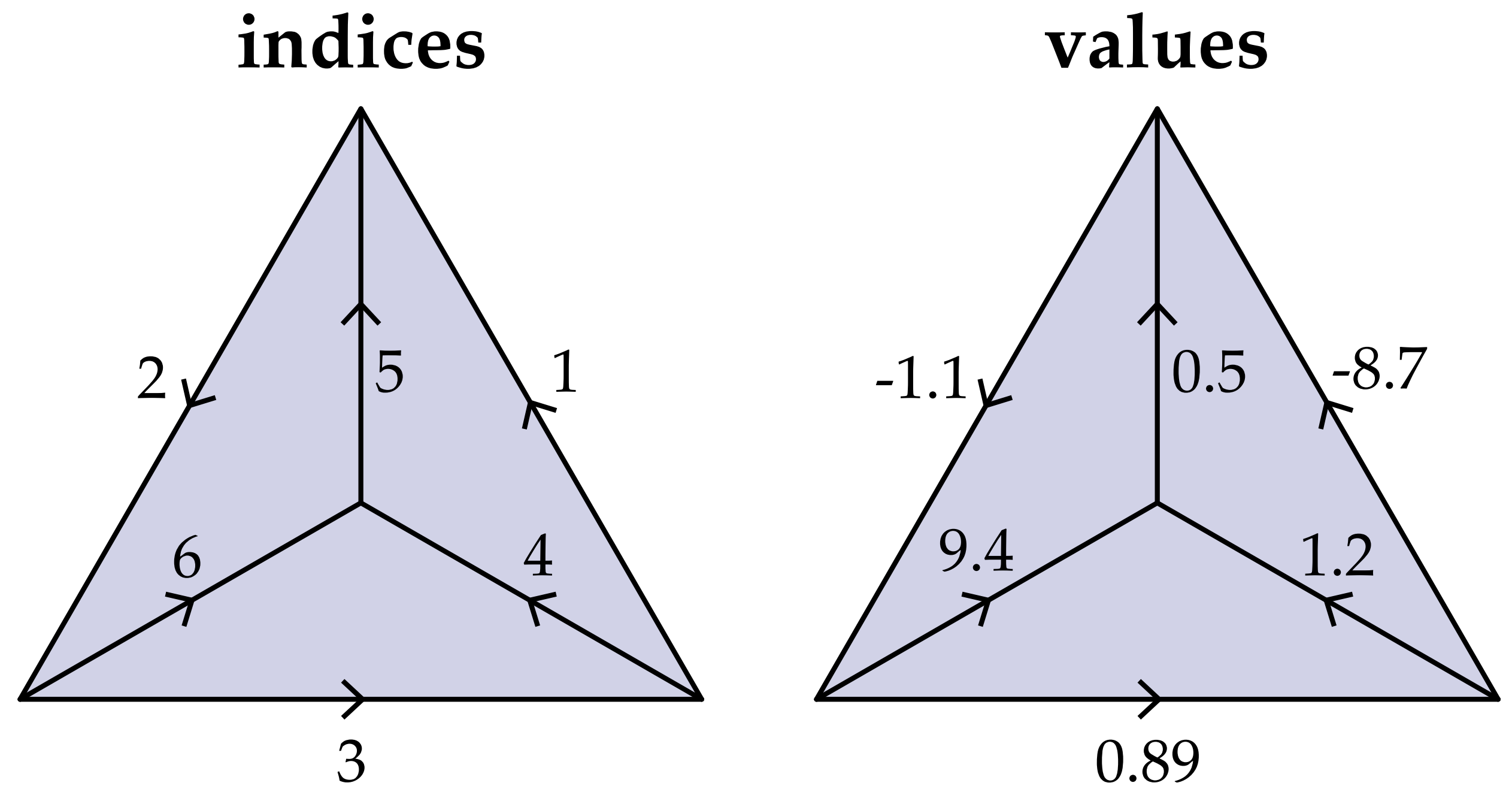

$$\alpha = [ -8.7 \quad -1.1 \quad 0.89 \quad 1.2 \quad 0.5 \quad 9.4 ]^T$$

Careful that if we ever change the orientation of an edge, we must also negate the value in our row vector!

# Matrix Encoding of Discrete Differential 2-Form

- Same idea for encoding a discrete differential 2-form as a column vector
- Assign indices to each 2-simplex; now we know which values go in which entries

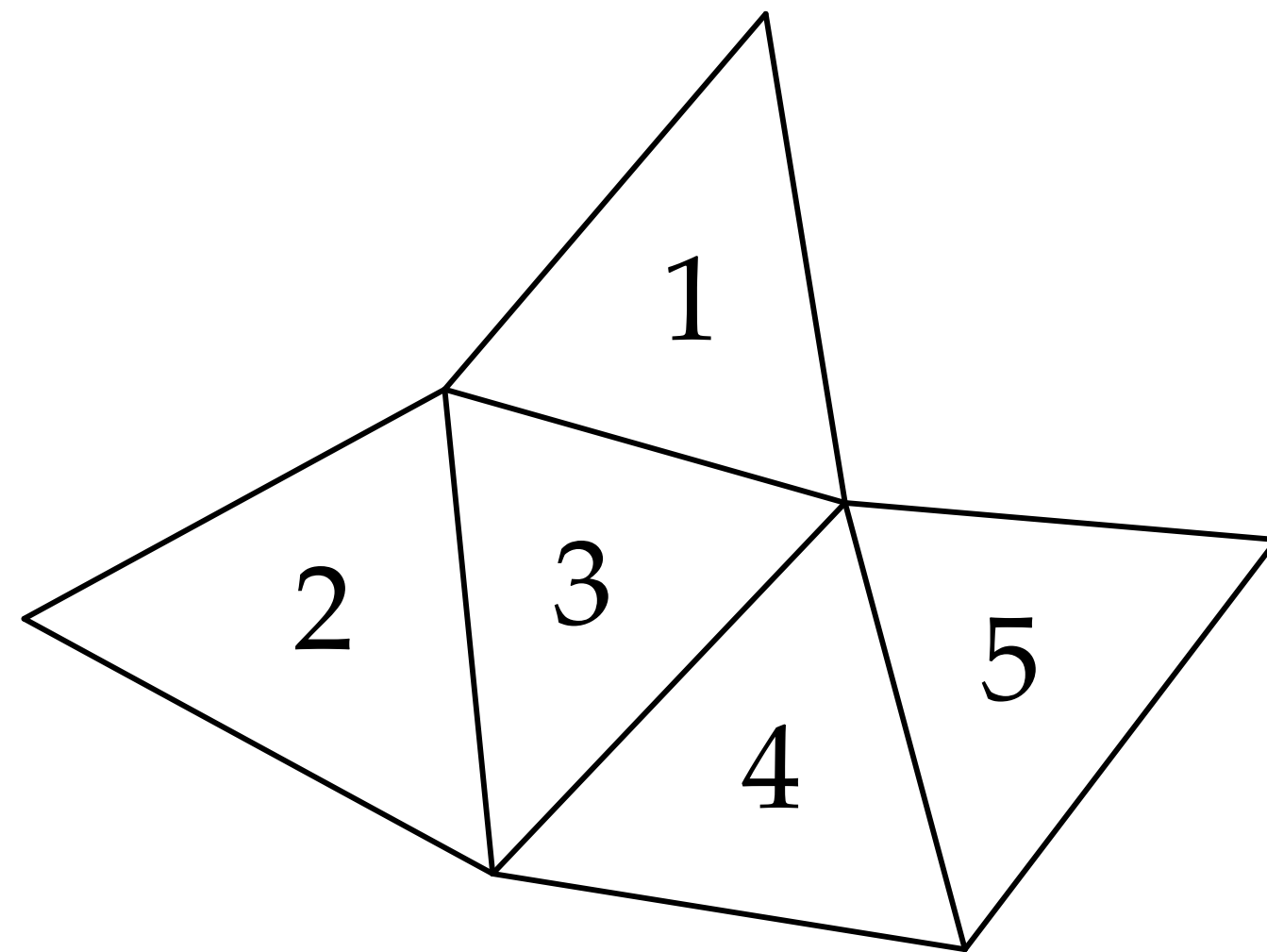

**indices**

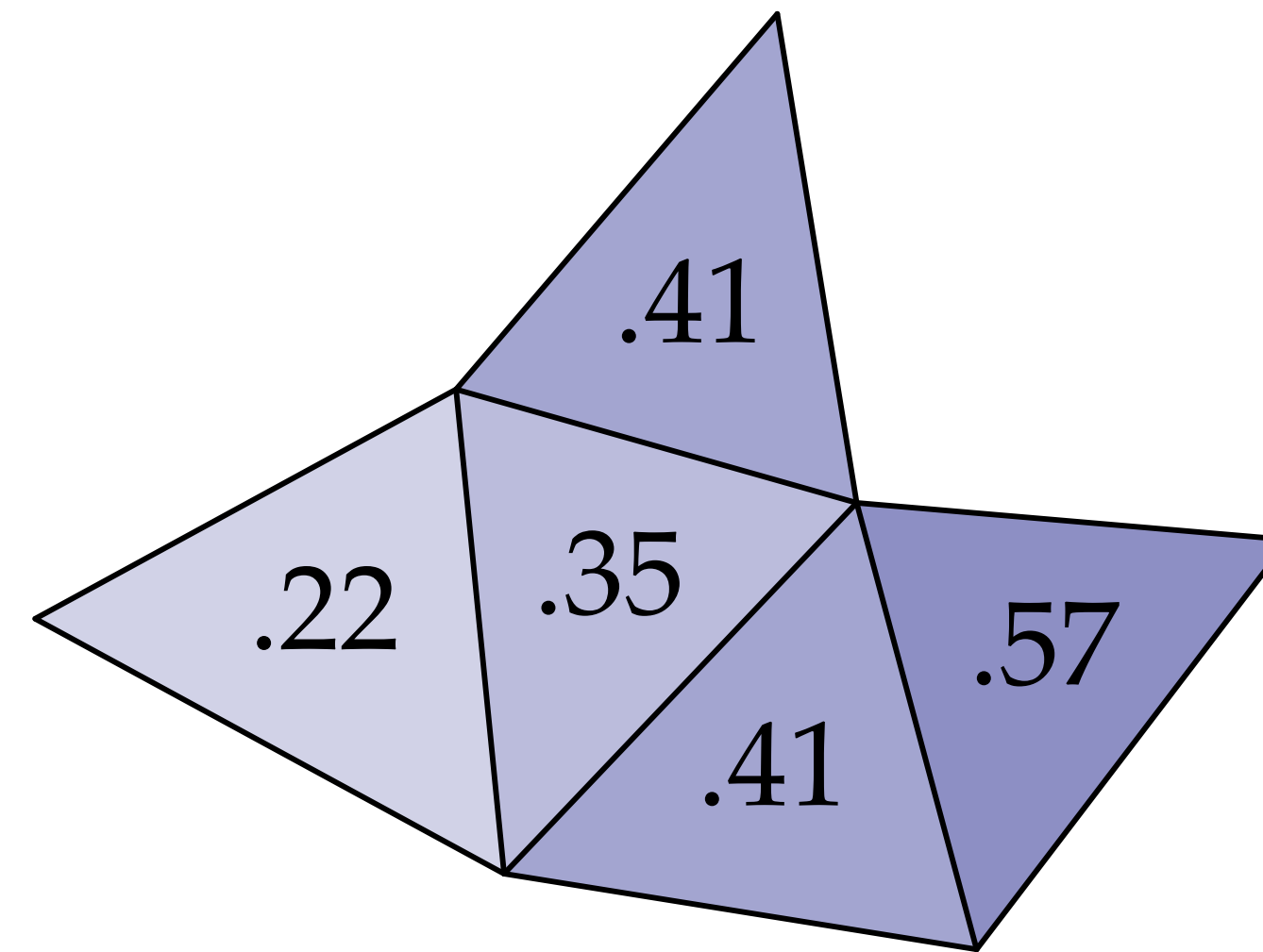

**values**

$$\omega = [ .41 \quad .22 \quad .35 \quad .41 \quad .57 ]$$



# Chains & Cochains

In the discrete setting, duality between “things that get measured” ( $k$ -vectors) and “things that measure” ( $k$ -forms) is captured by notion of *chains* and *cochains*.

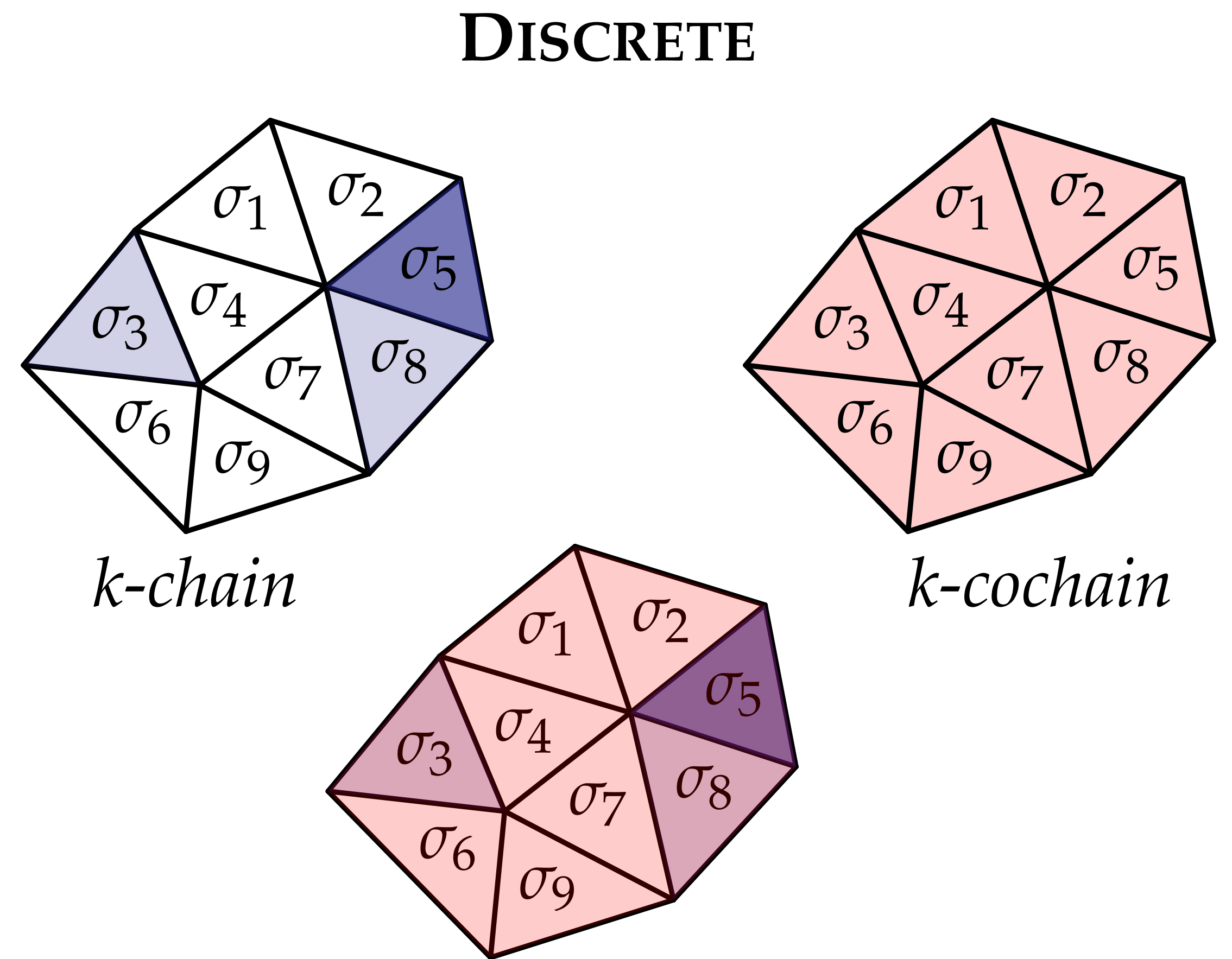
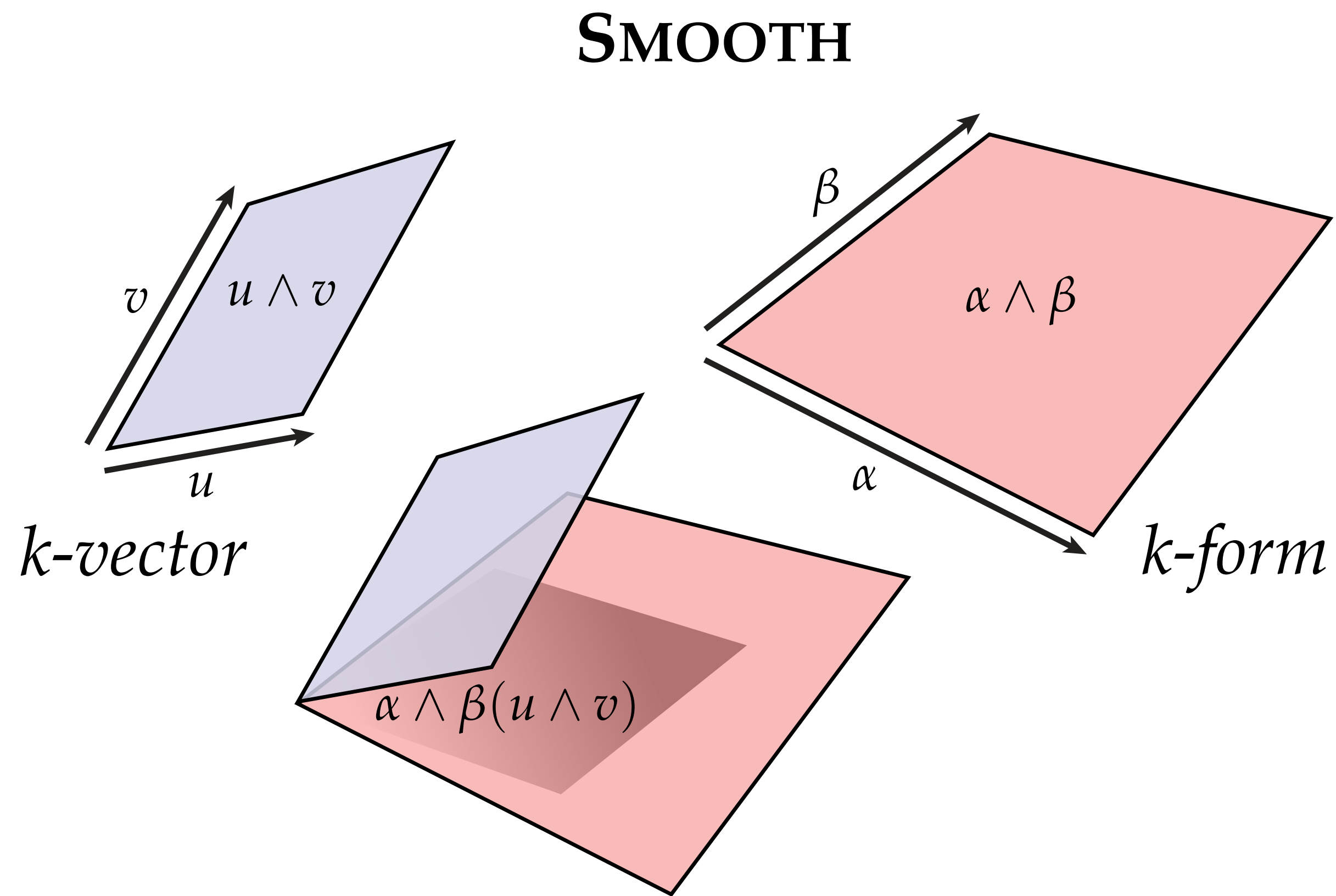

# Simplicial Chain

- Suppose we think of each  $k$ -simplex as its own basis vector
- Can specify some region of a mesh via a linear combination of simplices.

## Example.

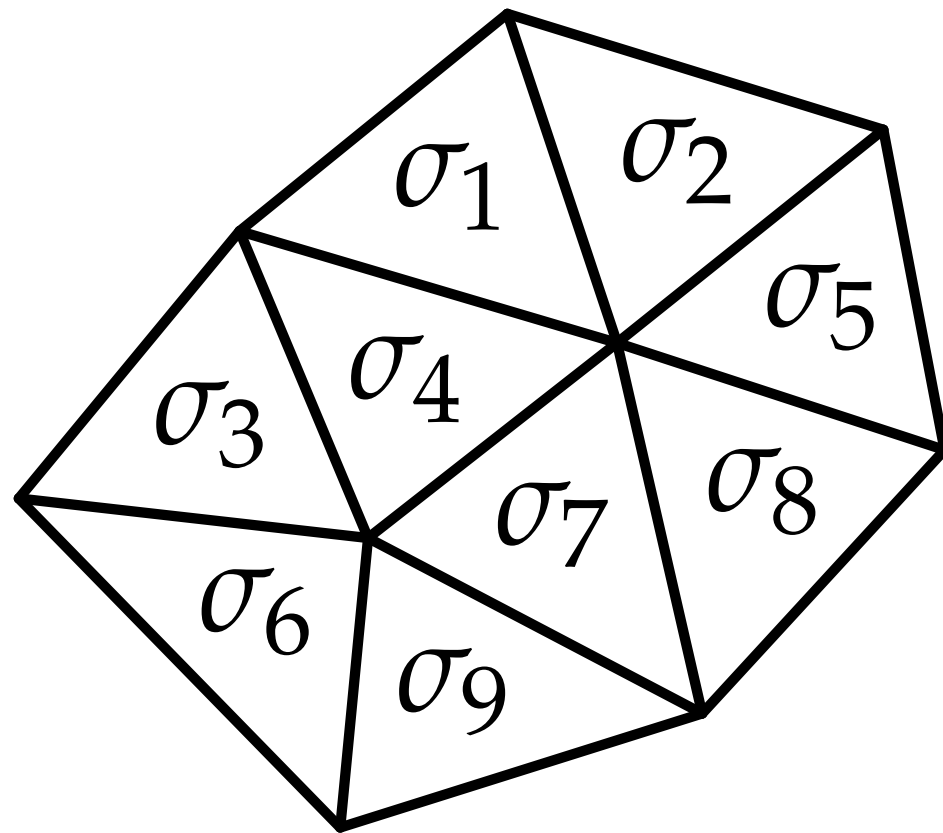

0

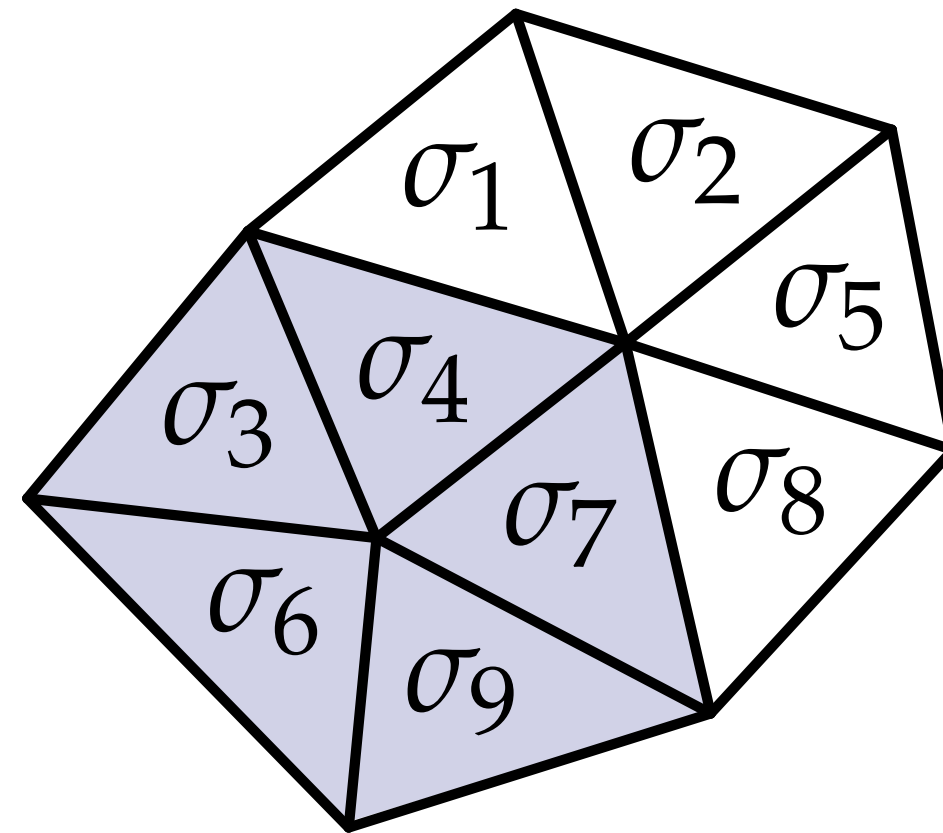

$$\sigma_3 + \sigma_4 + \sigma_6 + \sigma_7 + \sigma_9$$

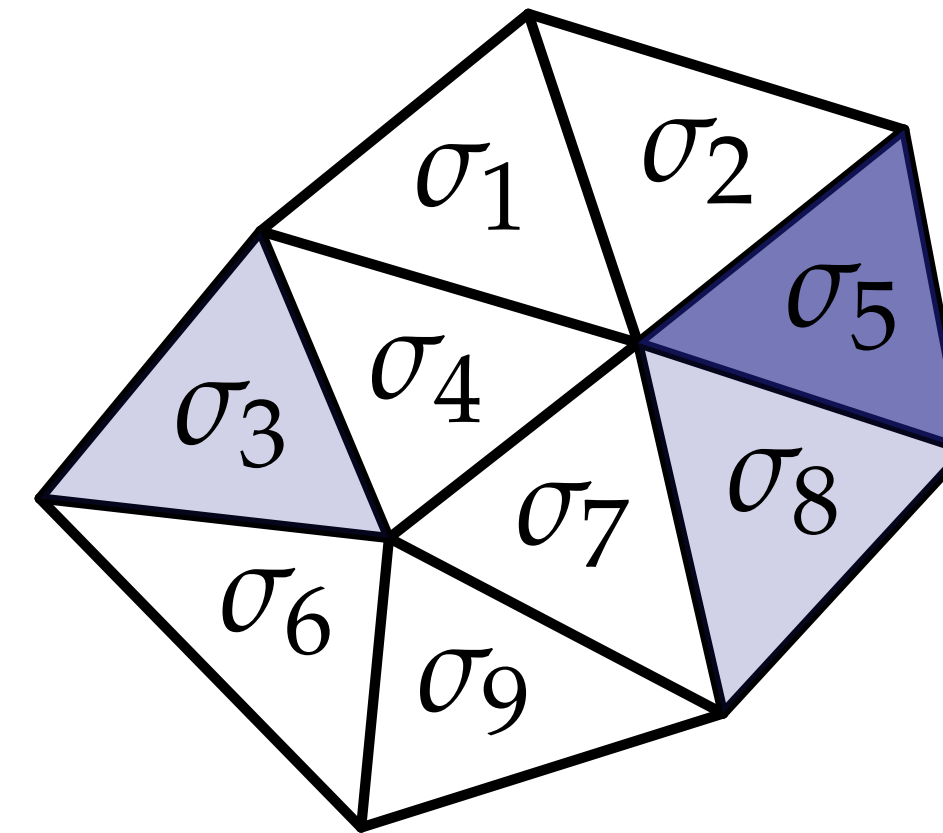

$$\sigma_3 + 3\sigma_5 + \sigma_8$$

**Q:** What does it mean when we have a coefficient other than 0 or 1? (Or *negative*?)

**A:** Roughly speaking, “ $n$  copies” of that simplex. (Or opposite *orientation*.)

(Formally: *chain group*  $C_k$  is the free abelian group generated by the  $k$ -simplices.)

# Arithmetic on Simplicial Chains

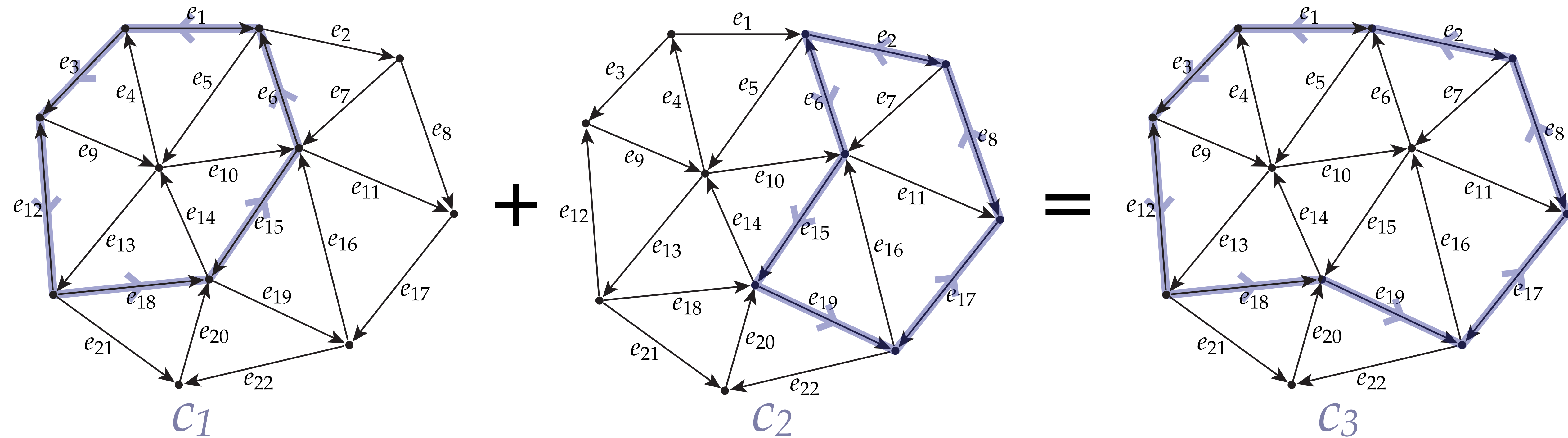

$$c_1 = e_3 - e_{12} + e_{18} - e_{15} + e_6 - e_1$$

$$c_2 = e_{15} + e_{19} - e_{17} - e_8 - e_2 - e_6$$

$$c_1 + c_2 = e_3 - e_{12} + e_{18} - \cancel{e_{15}} + \cancel{e_6} - e_1 + \cancel{e_{15}} + e_{19} - e_{17} - e_8 - e_2 - \cancel{e_6}$$

$$= e_3 - e_{12} + e_{18} - e_1 + e_{19} - e_{17} - e_8 - e_2 =: c_3$$



# Boundary Operator on Simplices

**Definition.** Let  $\sigma := (v_{i_0}, \dots, v_{i_k})$  be an oriented  $k$ -simplex. Its *boundary* is the oriented  $k - 1$ -chain

$$\partial\sigma := \sum_{p=0}^k (-1)^p (v_{i_0}, \dots, \cancel{v_{i_p}}, \dots, v_{i_k}),$$

where  $\cancel{v_{i_p}}$  indicates that the  $p$ th vertex has been omitted.

**Example.** Consider the 2-simplex  $\sigma := (v_0, v_1, v_3)$ .  
Its boundary is the 1-chain  $(v_0, v_1) + (v_1, v_3) + (v_3, v_0)$ .

**Example.** Consider the 1-simplex  $e := (v_0, v_1)$ .  
Its boundary is the 0-chain  $\partial e = v_1 - v_0$ .

**Example.** Consider the 0-simplex  $(v_1)$ .  
Its boundary is the empty set.

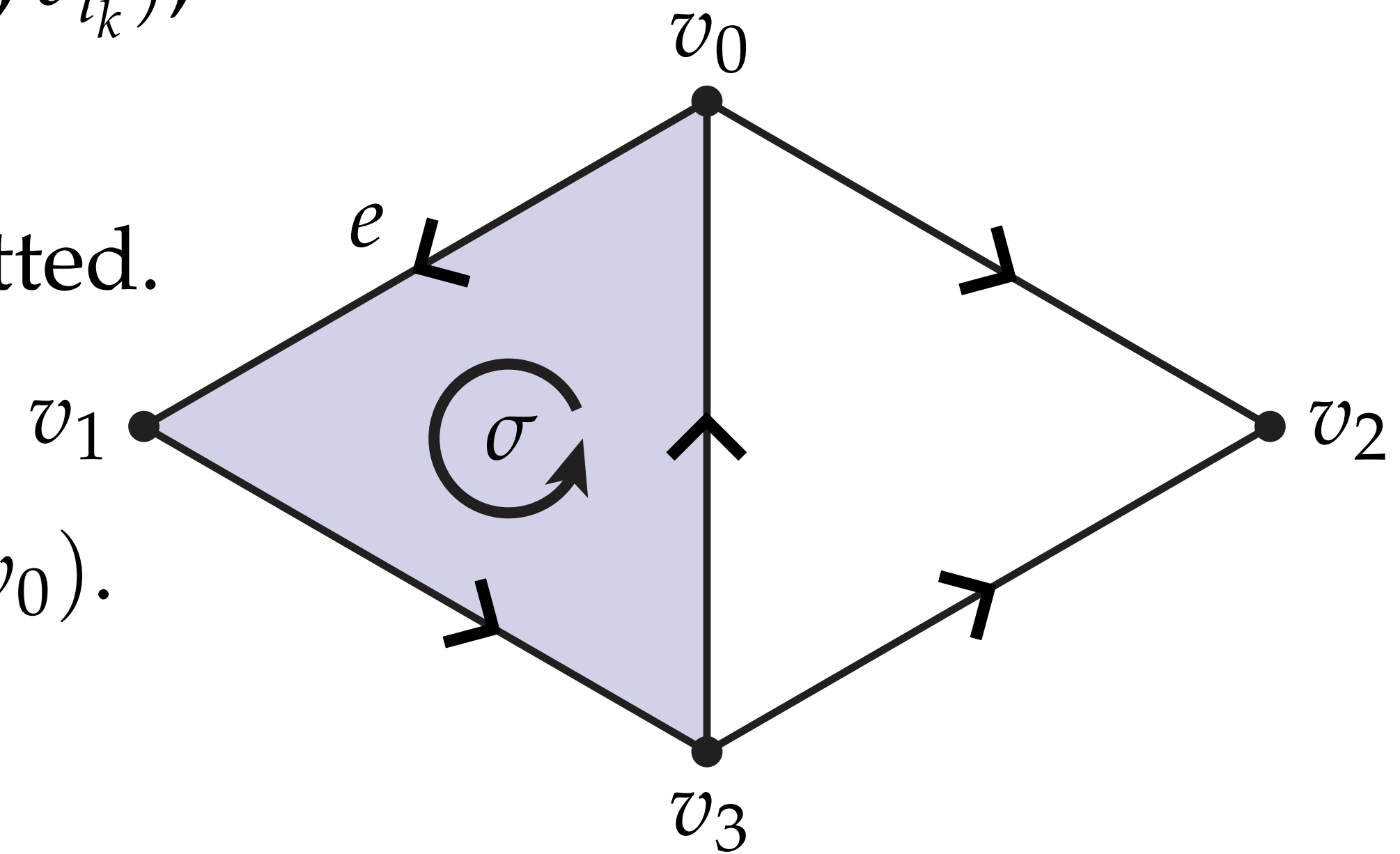

# Boundary Operator on Simplicial Chains

The boundary operator can be extended to any chain by linearity, *i.e.*,

$$\partial \sum_i c_i \sigma_i = \sum_i c_i \partial_i \sigma_i.$$

**Example.**

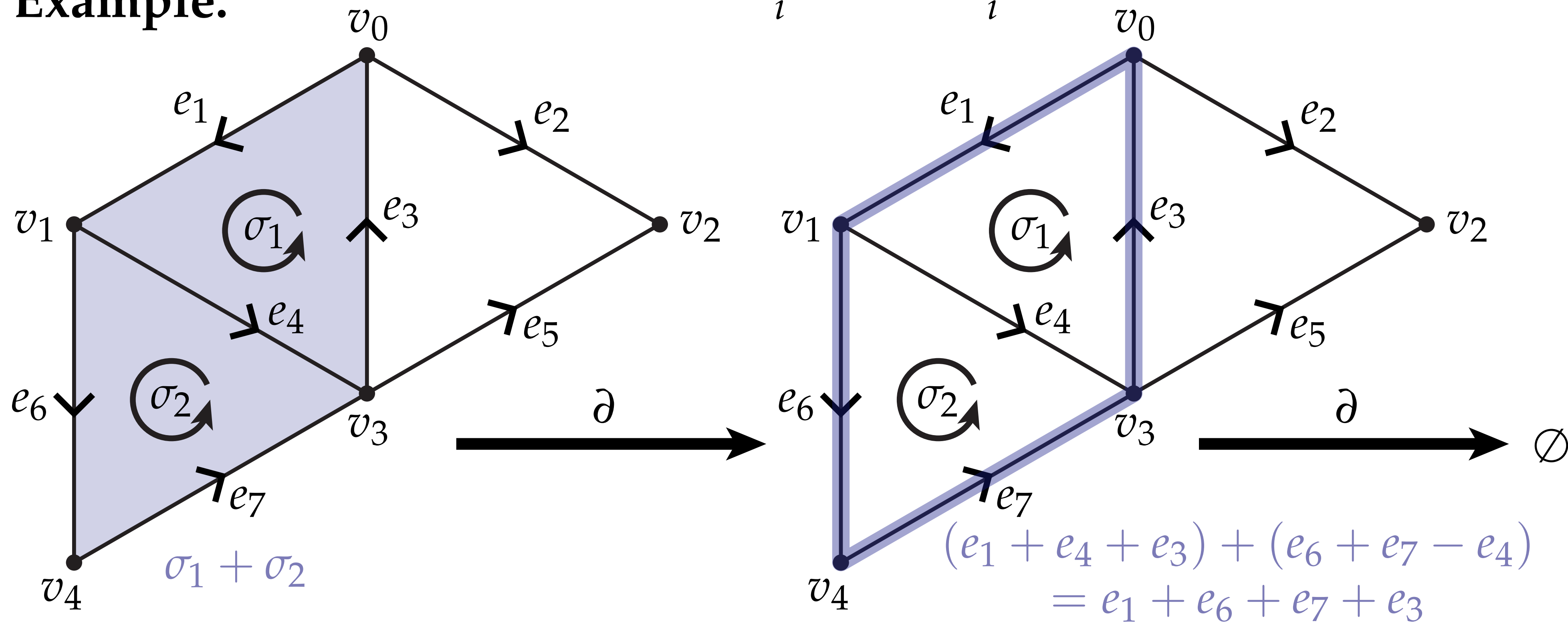

**Note:** boundary of boundary is *always* empty!

# Coboundary Operator on Simplices

The *coboundary* of an oriented  $k$ -simplex  $\sigma$  is the collection of all oriented  $(k+1)$ -simplices that contain  $\sigma$ , and which have the same relative orientation.

Example.

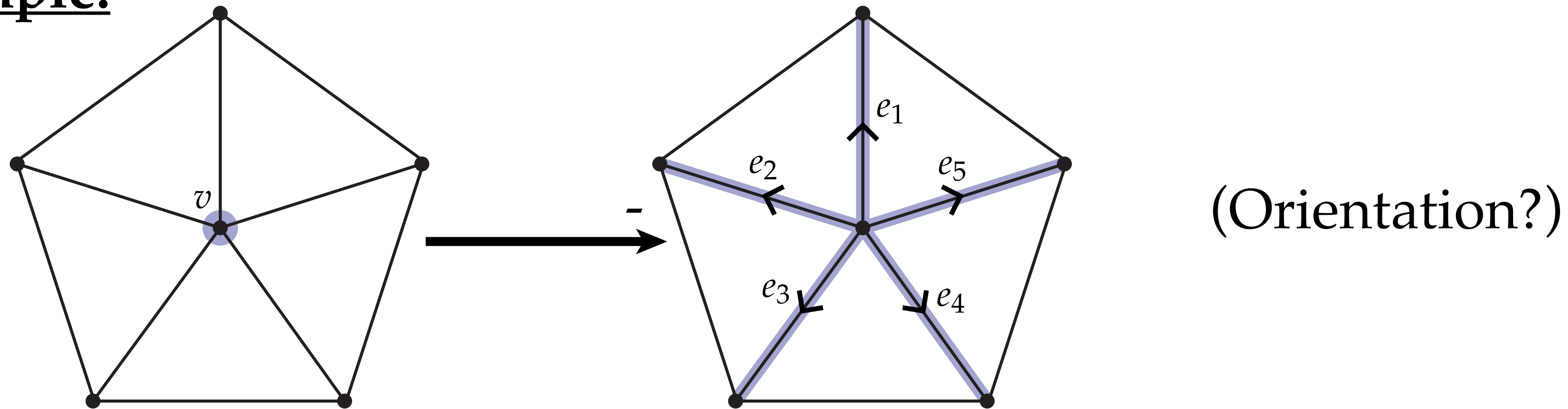

Example.

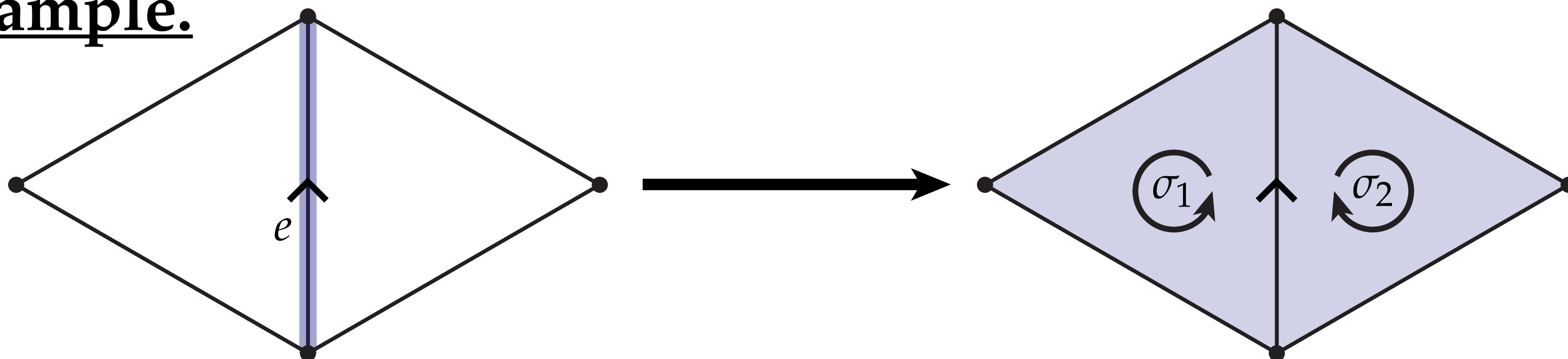



# Simplicial Cochain

A *simplicial  $k$ -cochain* is basically any **linear** map from a simplicial  $k$ -chain to a number.

$$\alpha(c_1\sigma_1 + \cdots + c_n\sigma_n) = \sum_{i=1}^n \alpha_i c_i$$

## Example.

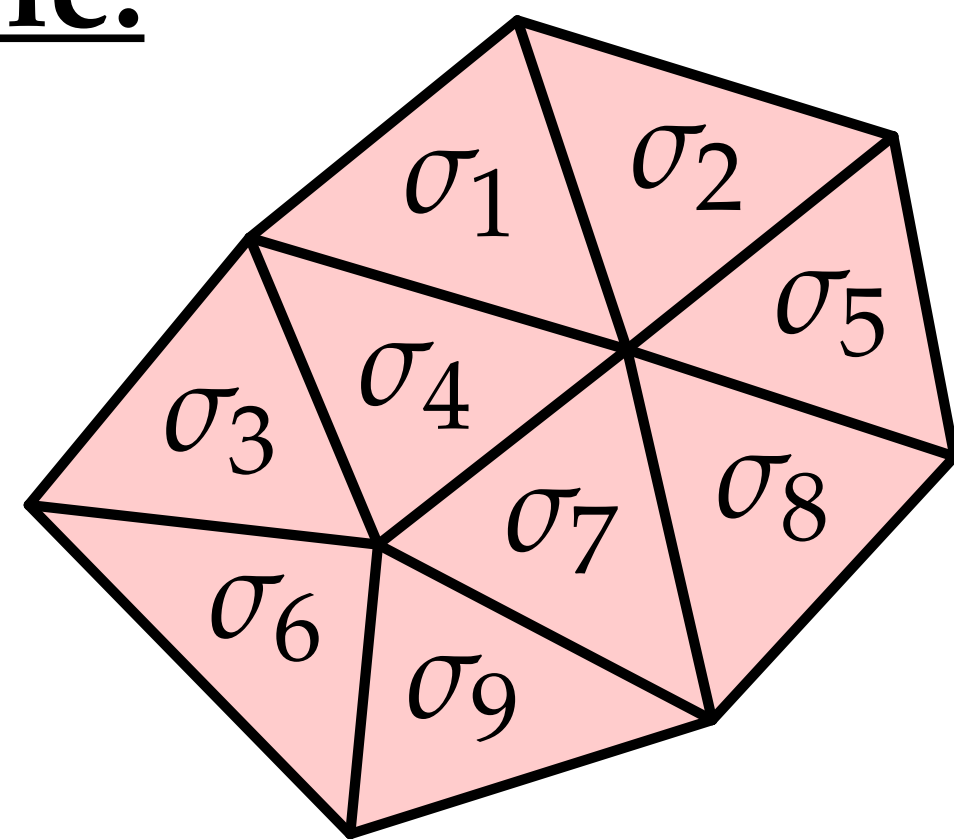

$$\forall i, \alpha(\sigma_i) = 1$$

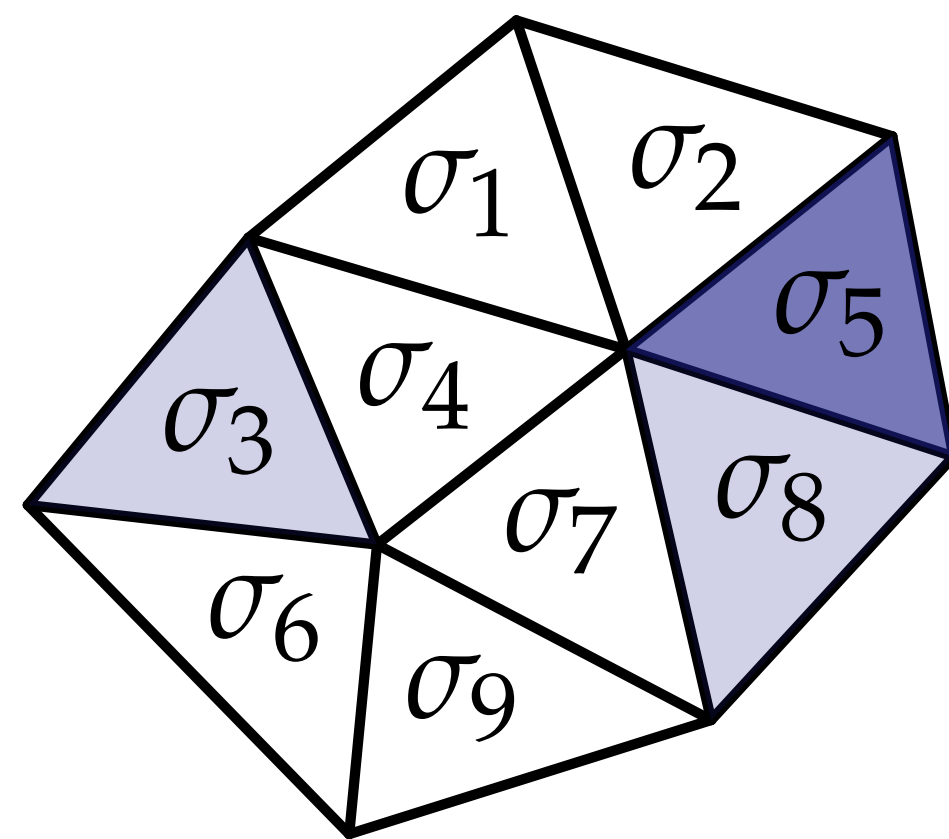

$$\sigma_3 + 3\sigma_5 + \sigma_8$$

$$[1 \ 1 \ 1 \ 1 \ 1 \ 1 \ 1 \ 1 \ 1] \begin{bmatrix} 0 \\ 0 \\ 1 \\ 0 \\ 3 \\ 0 \\ 0 \\ 1 \\ 0 \end{bmatrix} = 1 + 3 + 1 = 5$$

(Formally: *cochain group* is group of homomorphisms from cochains to reals.)

# Simplicial Cochains & Discrete Differential Forms

Suppose a simplicial  $k$ -cochain is given by the integrated values from a discrete  $k$ -form

**Q:** What does it mean (geometrically) when we apply it to a simplicial  $k$ -chain?

**A:** Our discrete  $k$ -form values come from integrating a smooth  $k$ -form over each  $k$ -simplex. So, we just get the integral over the region specified by the chain:

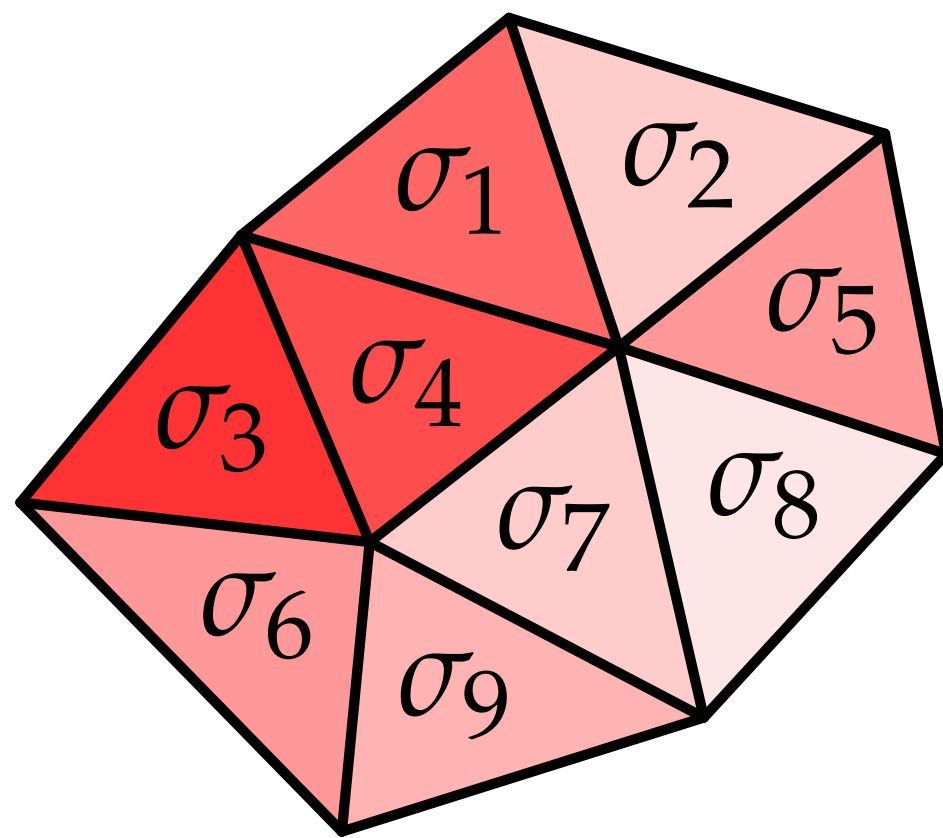

$$\hat{\alpha}_i := \int_{\sigma} \alpha$$

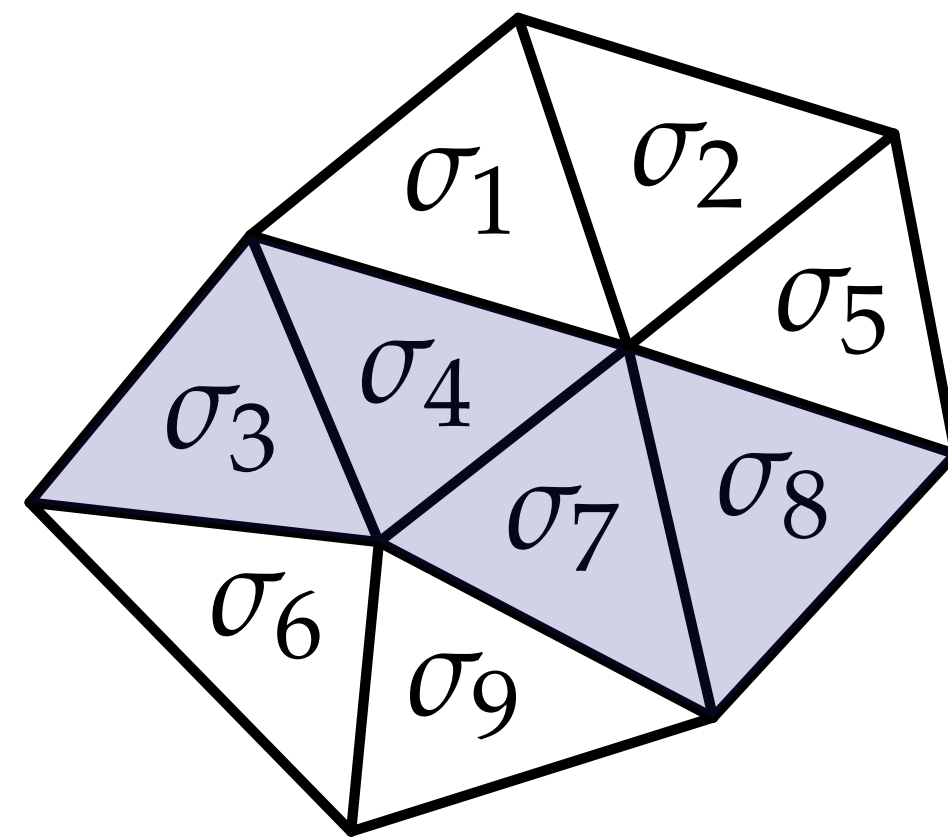

$$c = \sigma_3 + \sigma_4 + \sigma_7 + \sigma_8$$

$$\begin{aligned} \hat{\alpha}(c) &= \hat{\alpha}_3 + \hat{\alpha}_4 + \hat{\alpha}_7 + \hat{\alpha}_8 \\ &= \int_{\sigma_3 \cup \sigma_4 \cup \sigma_7 \cup \sigma_8} \alpha \end{aligned}$$

# Discrete Differential Form

**Definition.** Let  $M$  be a manifold simplicial complex. A (primal) *discrete differential  $k$ -form* is a simplicial  $k$ -cochain on  $M$ . We will use  $\Omega_k$  to denote the set of  $k$ -forms.

**SMOOTH**

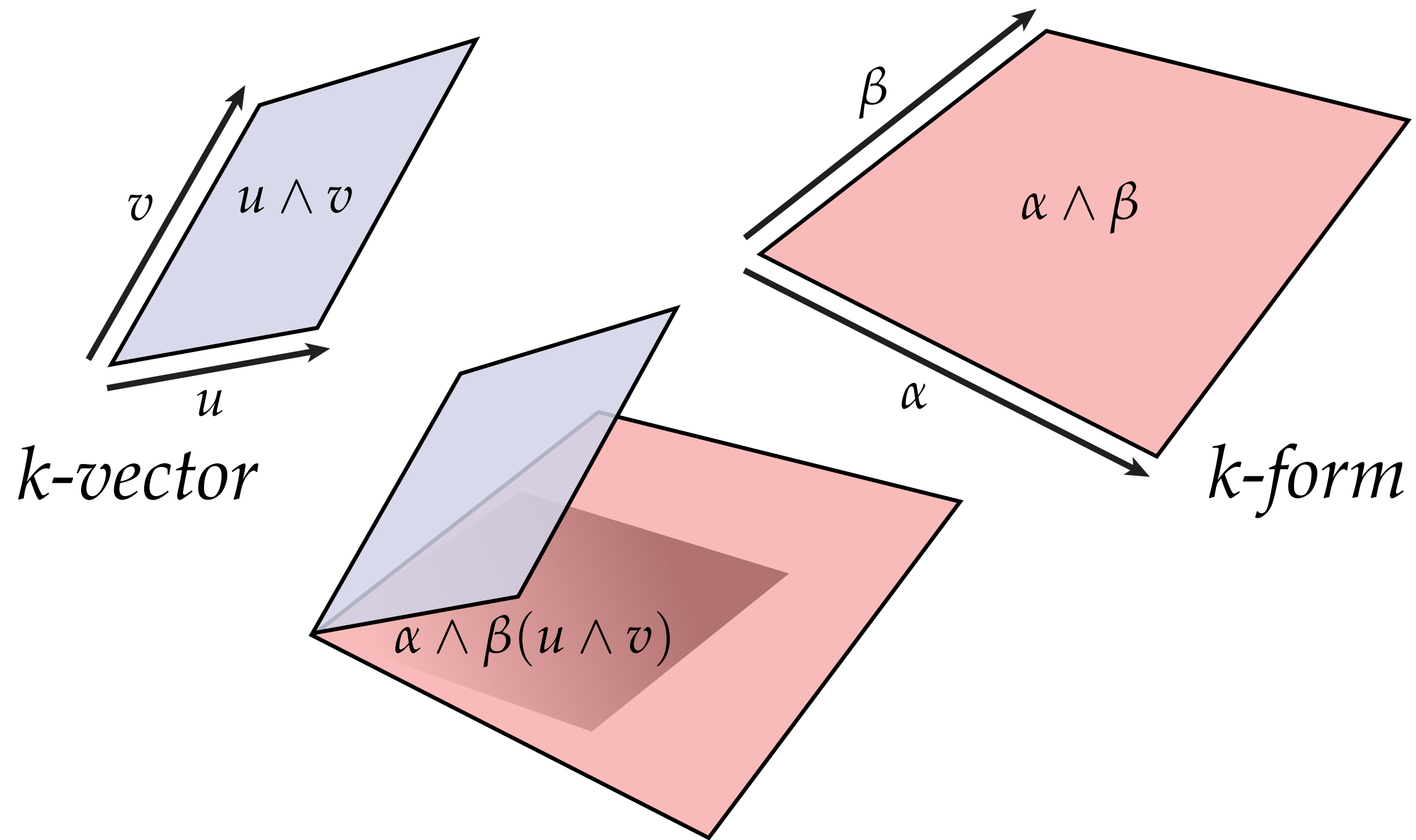

**DISCRETE**

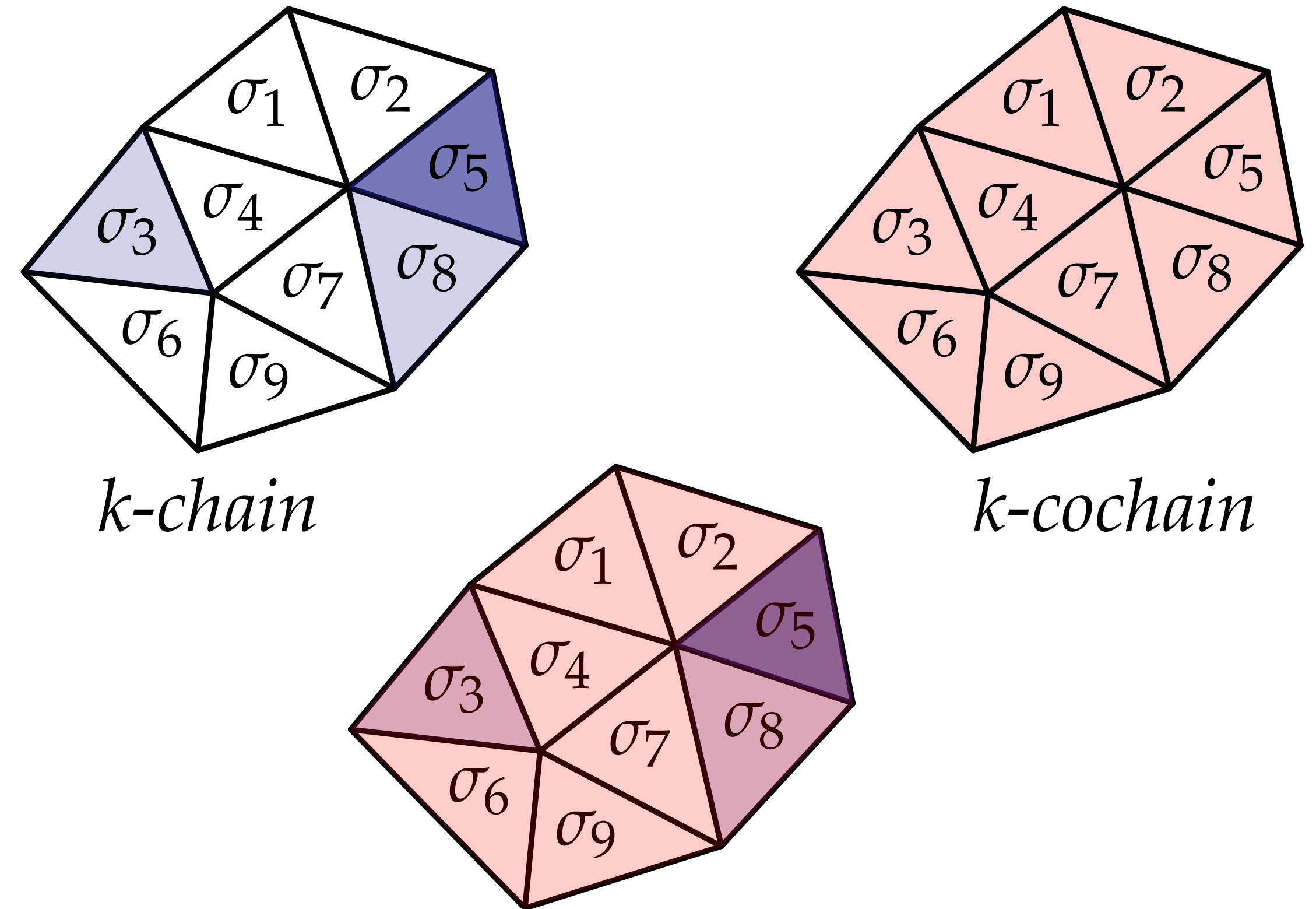



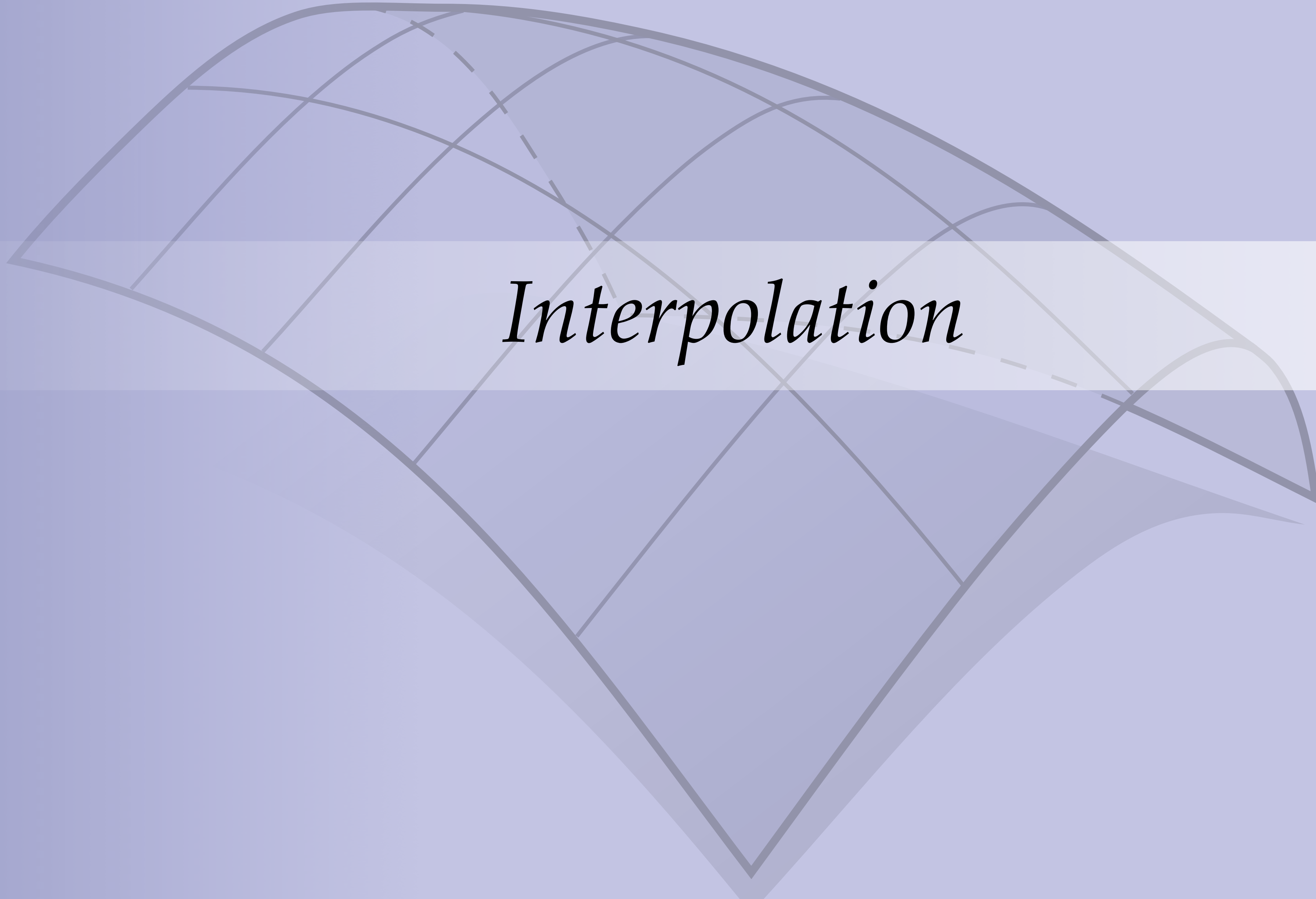

*Interpolation*

# Interpolation — 0-Forms

On any simplicial complex  $K$ , the *hat function* a.k.a. *Lagrange basis*  $\phi_i$  is a real-valued function that is linear over each simplex and satisfies

$$\phi_i(v_j) = \delta_{ij},$$

for each vertex  $v_j$ , *i.e.*, it equals 1 at vertex  $i$  and 0 at vertex  $j$ . Given a (primal) discrete 0-form  $u : V \rightarrow \mathbb{R}$ , we can construct an *interpolating* 1-form via

$$\sum_i u_i \phi_i,$$

*i.e.*, we simply weight the hat functions by values at vertices.

**Note:** result is a *continuous* 0-form.

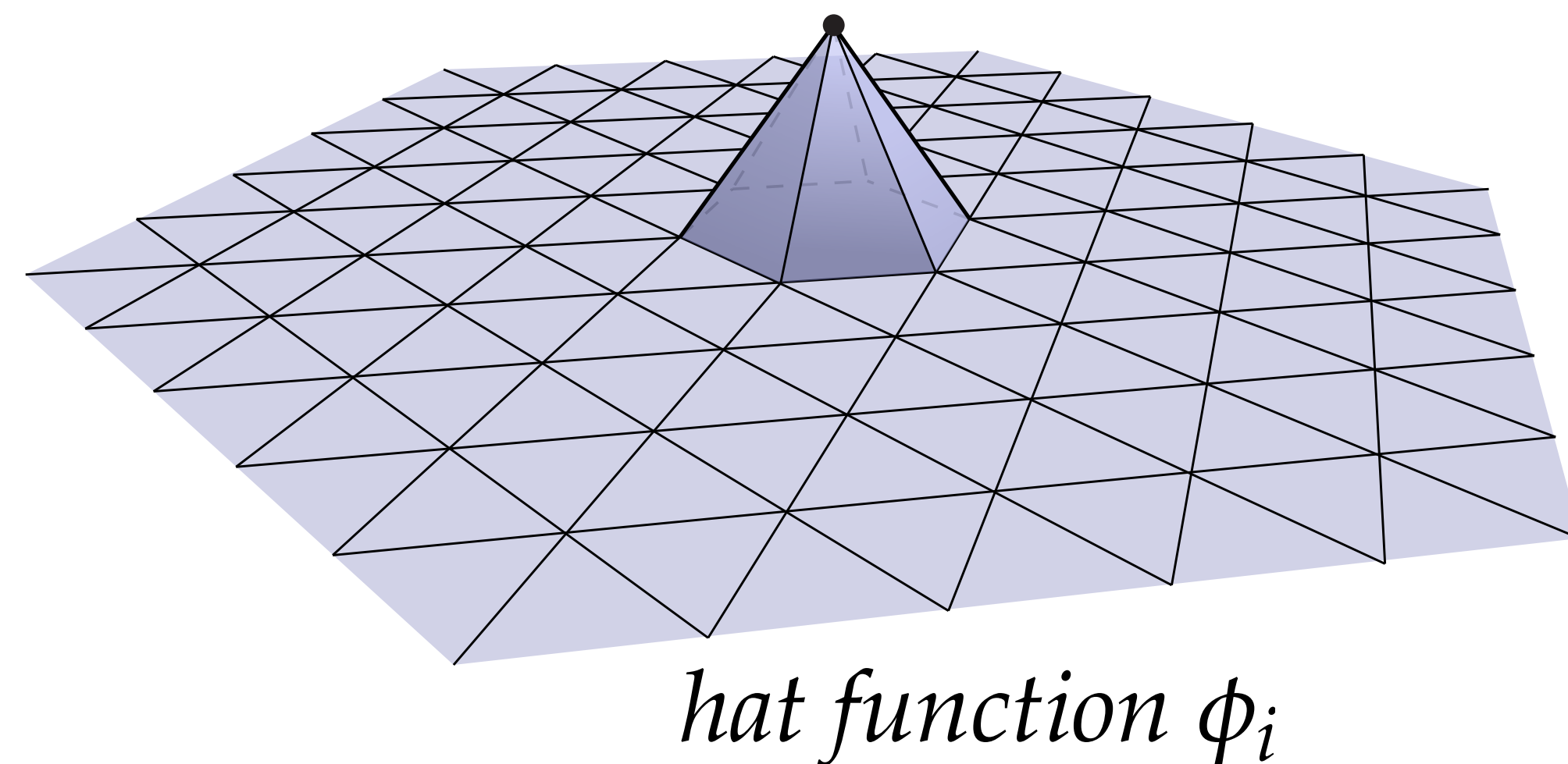

# Barycentric Coordinates—Revisited

- Recall that any point in a  $k$ -simplex can be expressed as a weighted combination of the vertices, where the weights sum to 1.
- The weights  $t_i$  are called the *barycentric coordinates*.
- The Lagrange basis for a vertex  $i$  is given explicitly by the barycentric coordinates of  $i$  in each triangle containing  $i$ .

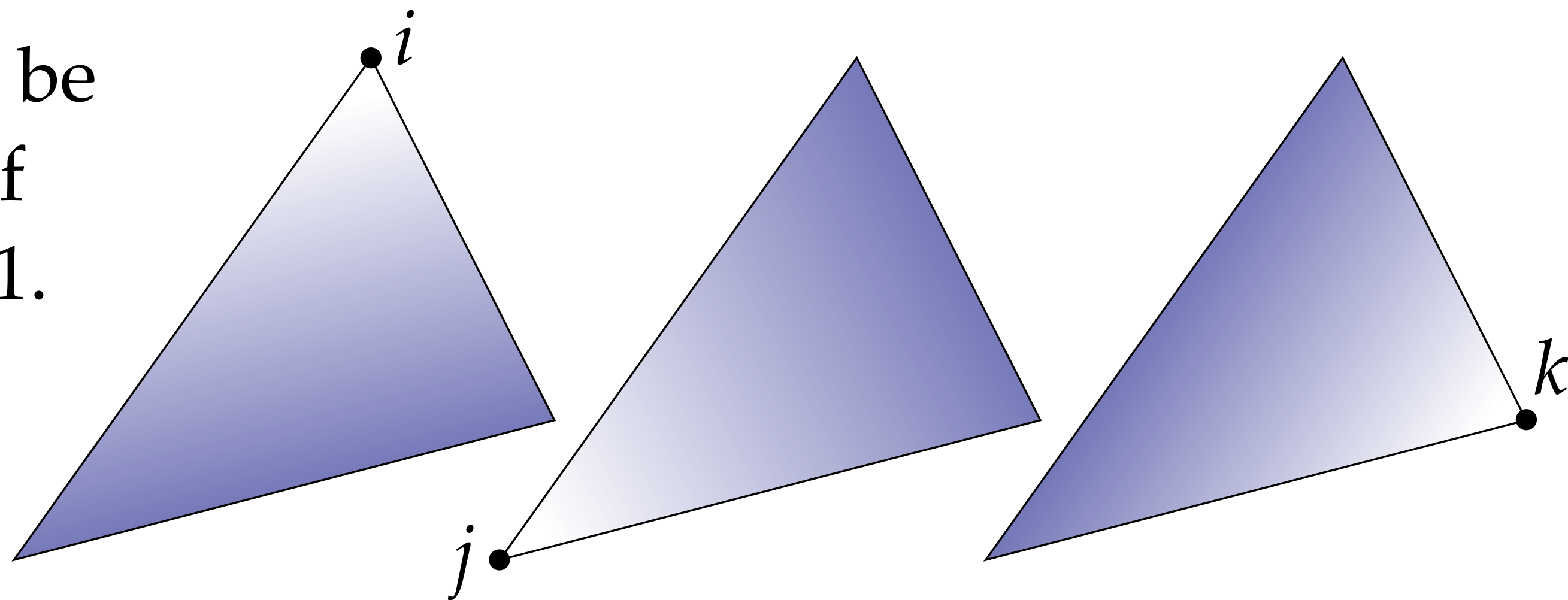

$$\sigma = \left\{ \sum_{i=0}^k t_i p_i \mid \sum_{i=0}^k t_i = 1, t_i \geq 0 \forall i \right\}$$

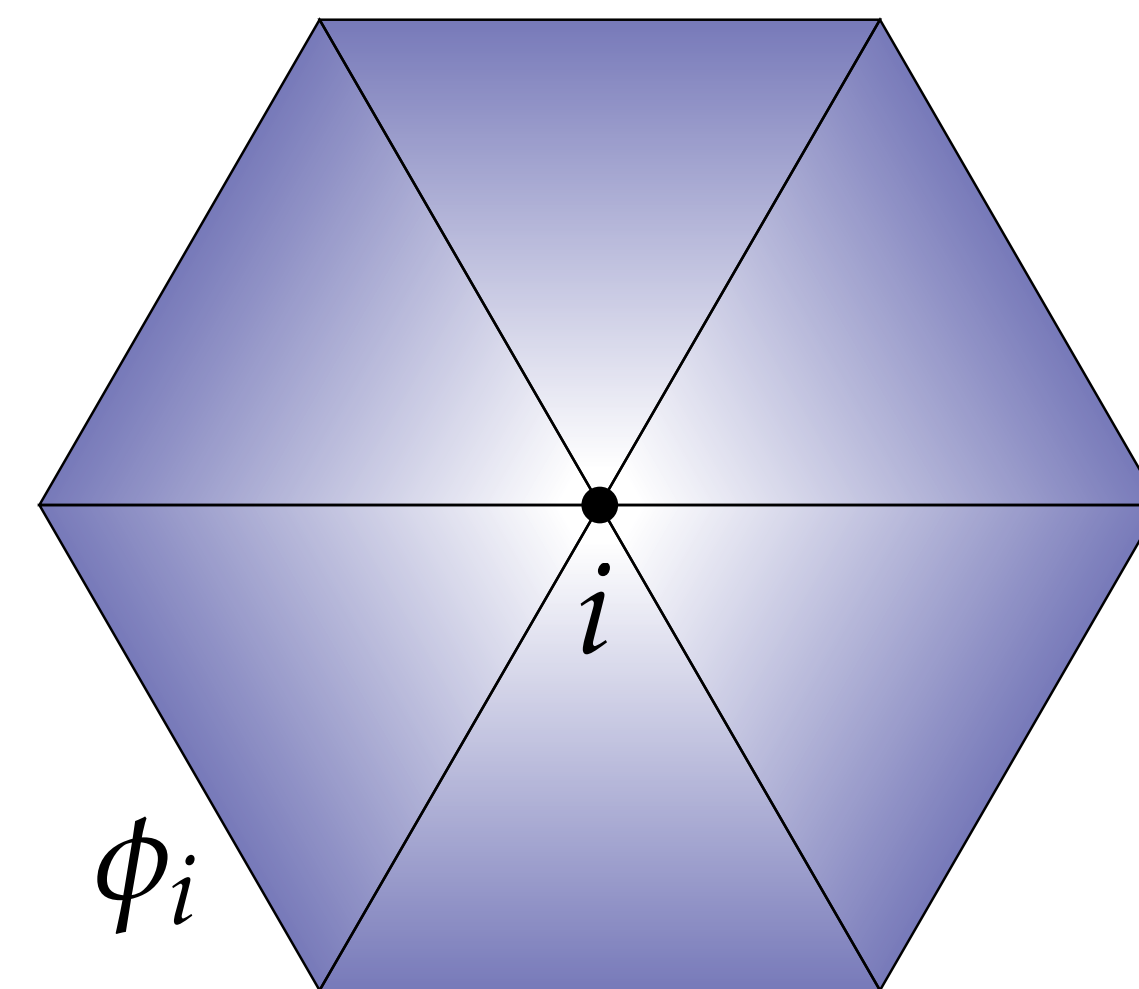
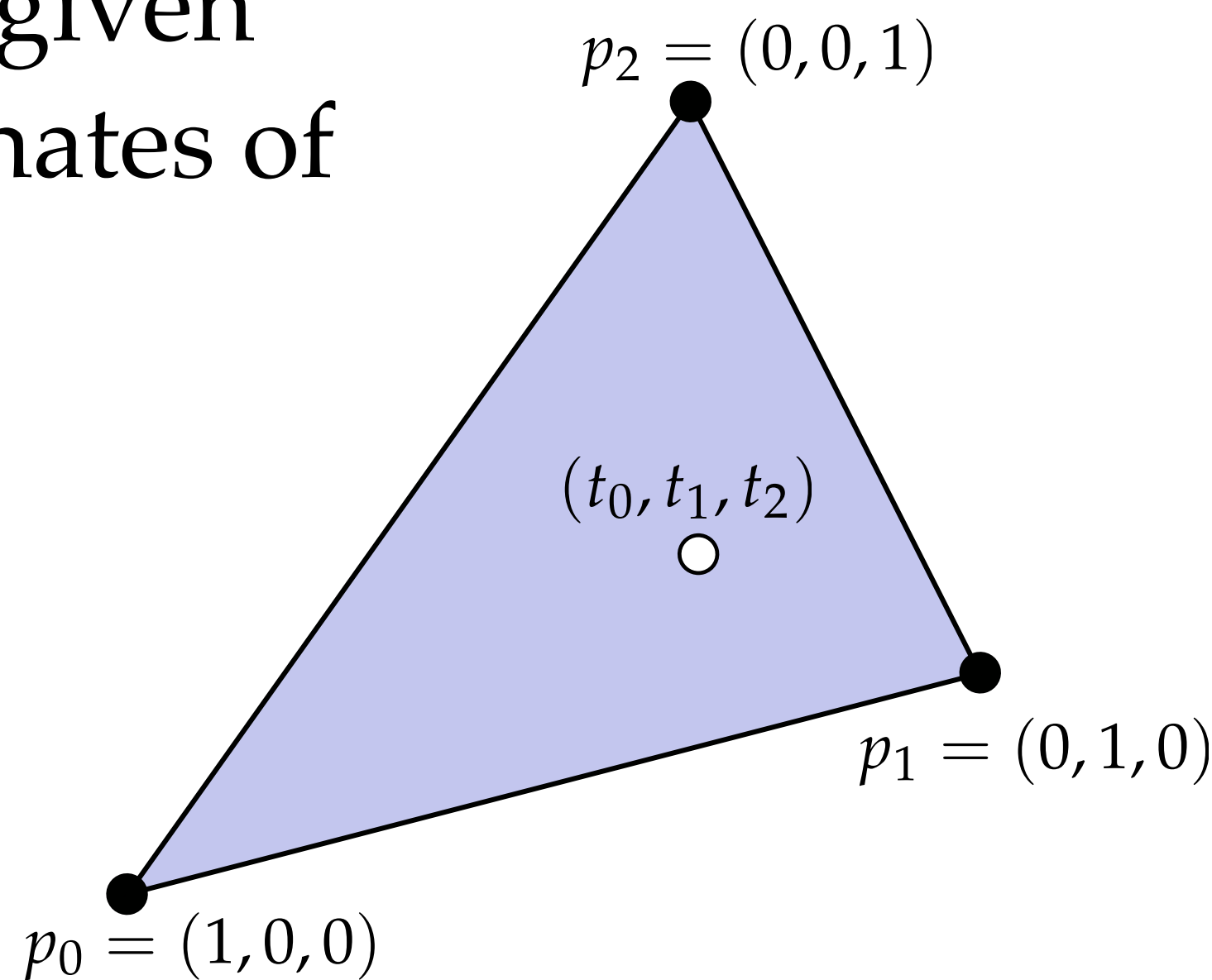



# Interpolation — $k$ -Forms (Whitney Map)

**Definition.** Let  $\phi_i$  be the hat functions on a simplicial complex. The *Whitney 1-forms* are differential 1-forms associated with each oriented edge  $ij$ , given by

$$\phi_{ij} := \phi_i d\phi_j - \phi_j d\phi_i$$

(Note that  $\phi_{ij} = -\phi_{ji}$ ). The Whitney 1-forms can be used to interpolate a discrete 1-form  $\hat{\omega}$  (value per edge) via

$$\sum_{ij} \hat{\omega}_{ij} \phi_{ij}.$$

More generally, the *Whitney  $k$ -form* associated with an oriented  $k$ -simplex  $(i_0, \dots, i_k)$  is given by

$$\sum_{p=0}^k (-1)^p \phi_{i_p} d\phi_{i_0} \wedge \dots \wedge \cancel{d\phi_{i_p}} \wedge \dots \wedge d\phi_{i_k}$$

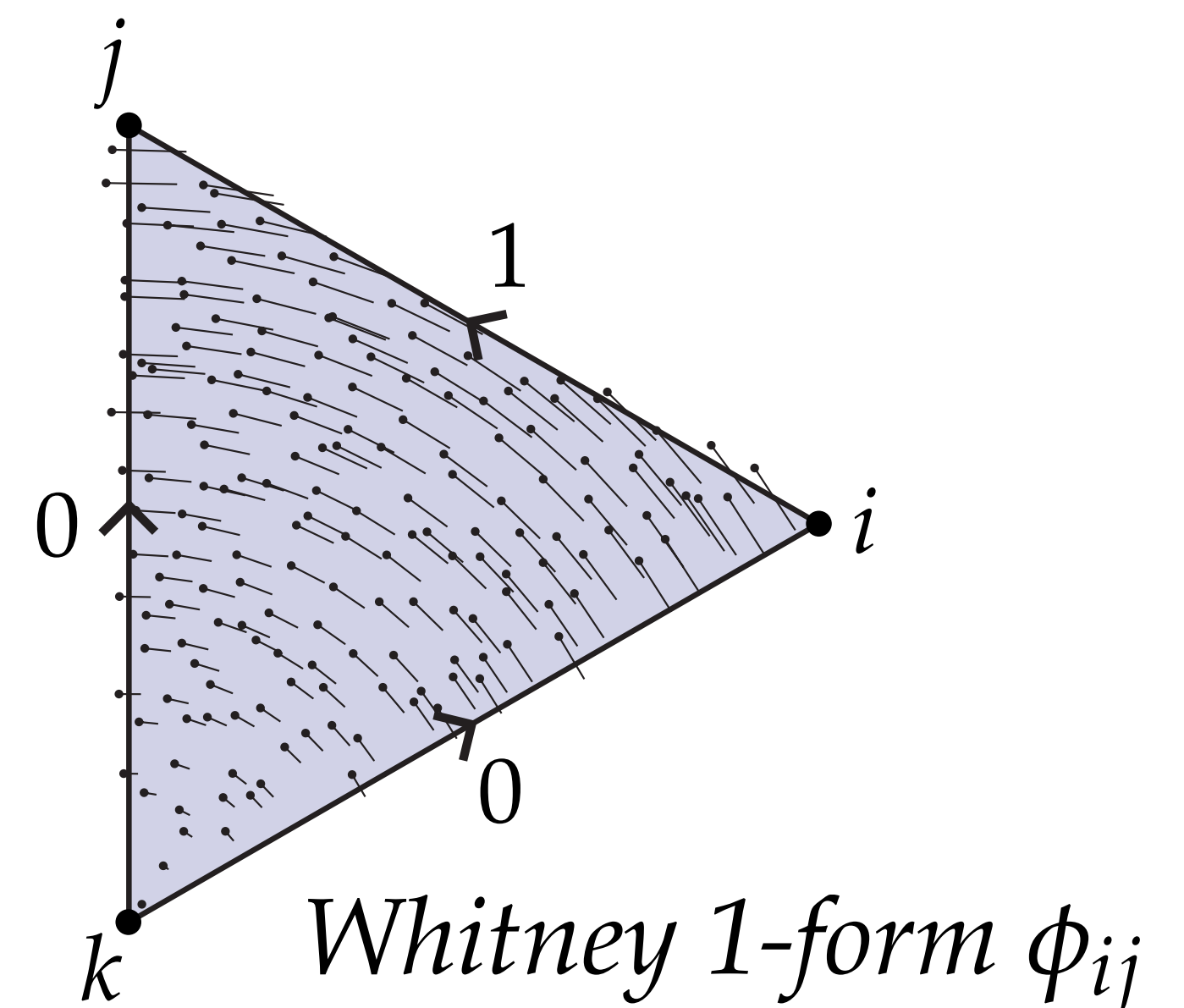

# Discretization & Interpolation

- **Fact:** Suppose we have a discrete differential  $k$ -form. If we interpolate by Whitney bases, then discretize via the de Rham map (i.e., by integration), then we recover the exact same discrete  $k$ -form.

$$\begin{array}{ccc} & \Omega_k & \text{(smooth differential } k\text{-forms)} \\ & \updownarrow & \\ \text{(discretize)} & \int & \phi \text{ (interpolate)} \\ & \downarrow & \\ & \hat{\Omega}_k & \text{(discrete differential } k\text{-forms)} \end{array}$$

**Q:** What about the other direction? If we discretize a continuous  $k$ -form then interpolate, will we always recover the same continuous  $k$ -form?



# *Summary*



# Discrete Differential Forms — Summary

- A *discrete differential  $k$ -form* amounts to a value stored on each oriented  $k$ -simplex
- **Discretization:** given a smooth differential  $k$ -form, can approximate by a discrete differential  $k$ -form by integrating over each  $k$ -simplex
- **Interpolation:** given a discrete differential  $k$ -form, construct a continuous one by taking a weighted sum of basis  $k$ -forms
- *In practice*, almost never comes from direct integration. More typically, values start at vertices (samples of some function); 1-forms, 2-forms, *etc.*, arise from applying operators like the (discrete) exterior derivative.
- Next lecture: develop these operators!

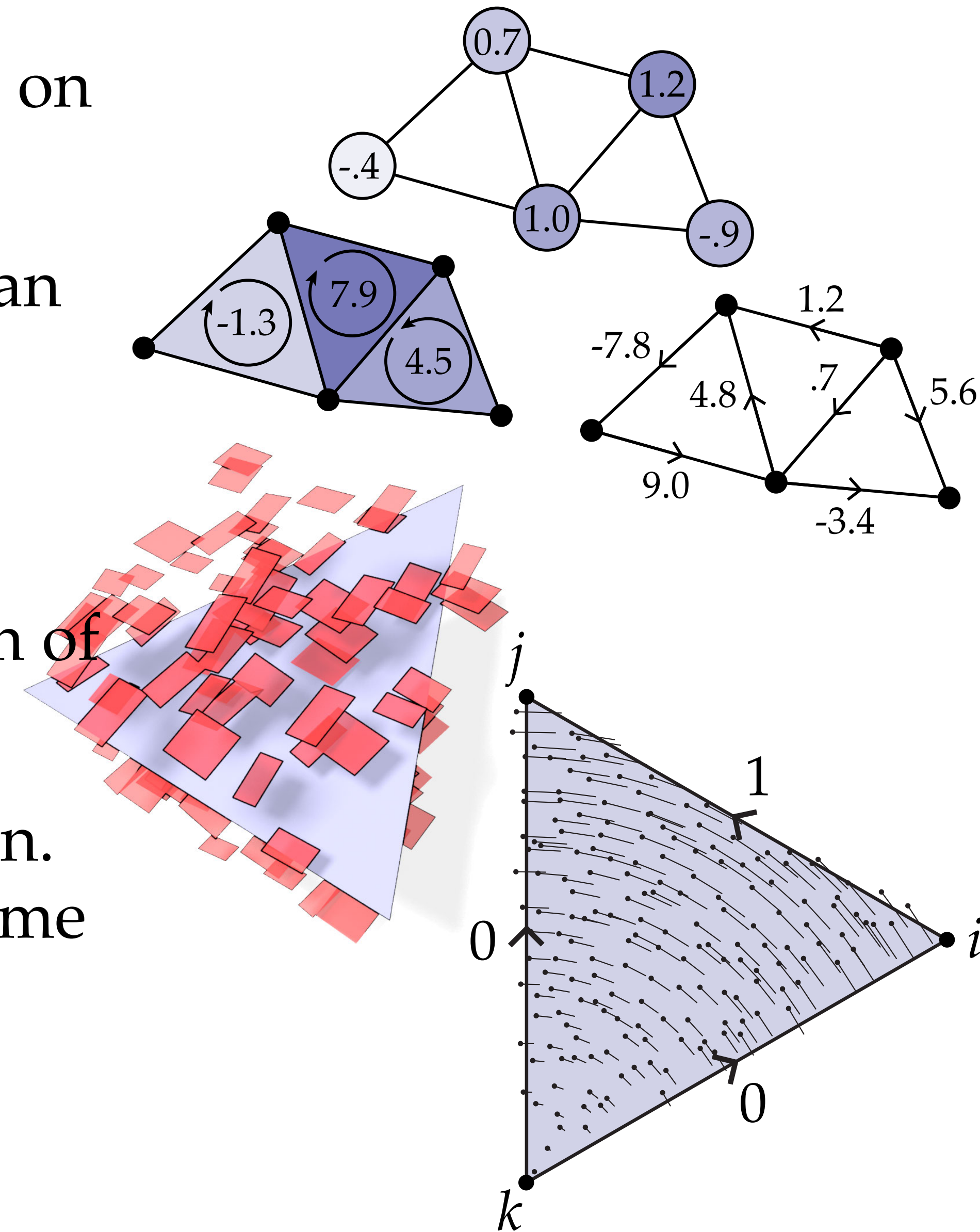

*Thanks!*

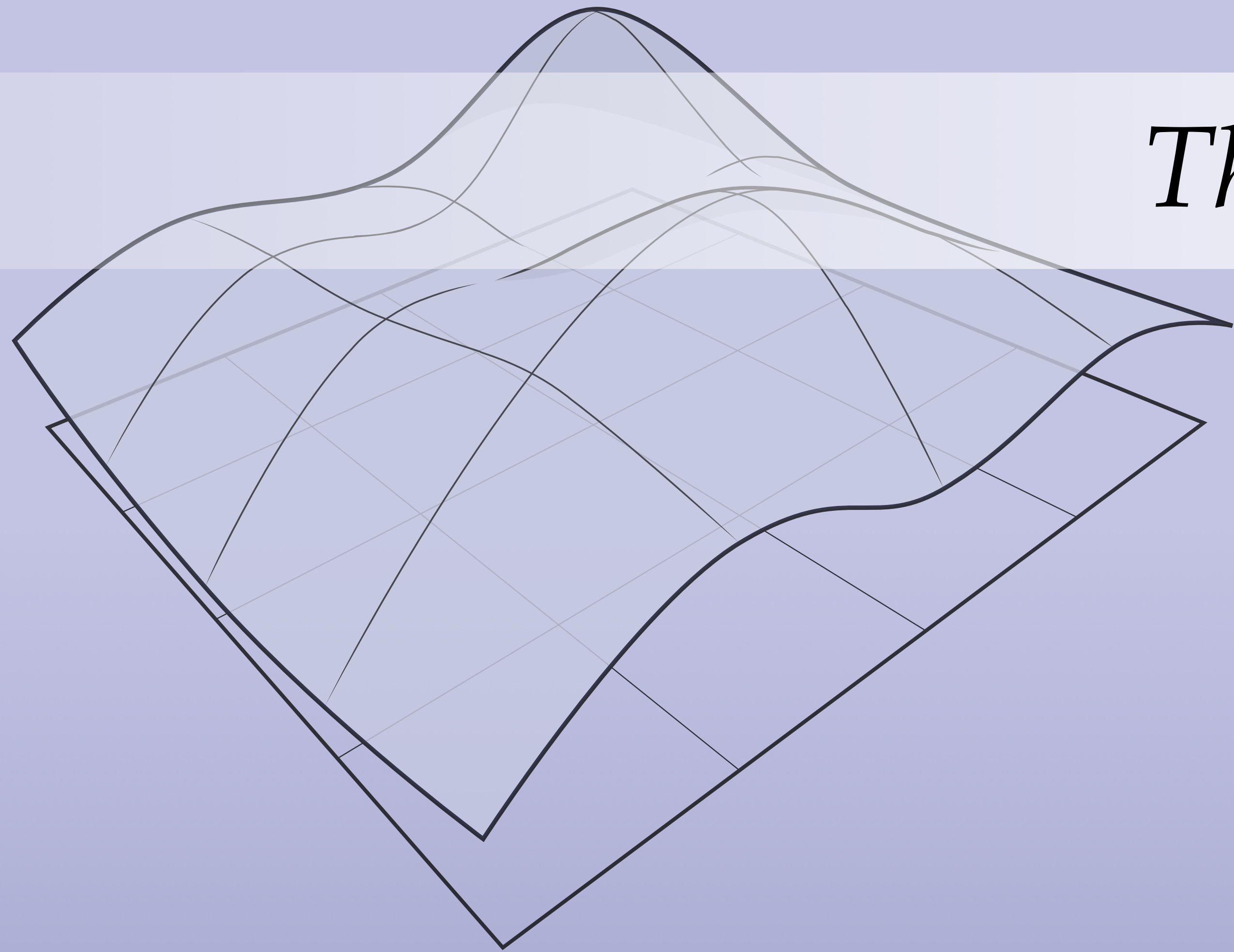

DISCRETE DIFFERENTIAL GEOMETRY  
AN APPLIED INTRODUCTION