

DISCRETE DIFFERENTIAL
GEOMETRY:
AN APPLIED INTRODUCTION
Keenan Crane • CMU 15-458/858

LECTURE 11:
DISCRETE CURVES

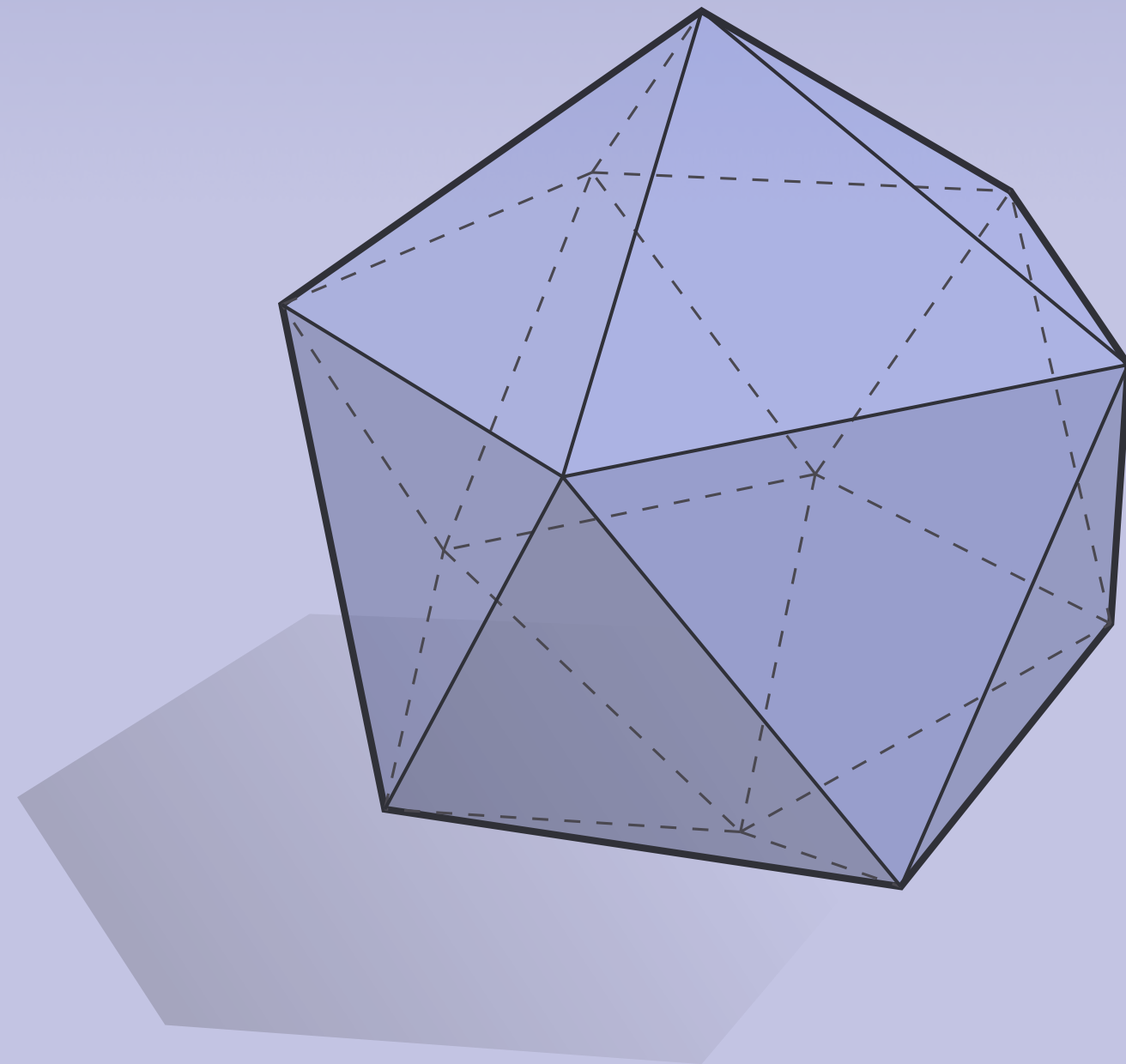

DISCRETE DIFFERENTIAL
GEOMETRY:
AN APPLIED INTRODUCTION

Keenan Crane • CMU 15-458/858

Curves, Surfaces, and Volumes

- In general, differential geometry studies n -dimensional manifolds; we'll focus mostly on low dimensions: curves ($n=1$), surfaces ($n=2$), and volumes ($n=3$)
- Why? Geometry we encounter in “every day life” (Common in applications!)
- Low-dimensional manifolds are not baby stuff! :-)
 - $n=1$: unknot recognition (open as of July 2017)
 - $n=2$: Willmore conjecture (2012 for genus 1)
 - $n=3$: Geometrization conjecture (2003, \$1 million)
- Serious intuition gained by studying low-dimensional manifolds
- Conversely, problems involving very high-dimensional manifolds (e.g., statistics / machine learning) involve less “deep” geometry than you might imagine!
 - *fiber bundles, Lie groups, curvature flows, spinors, symplectic structure, ...*
- Moreover... curves and surfaces are beautiful! (And sometimes boring for large n ...)

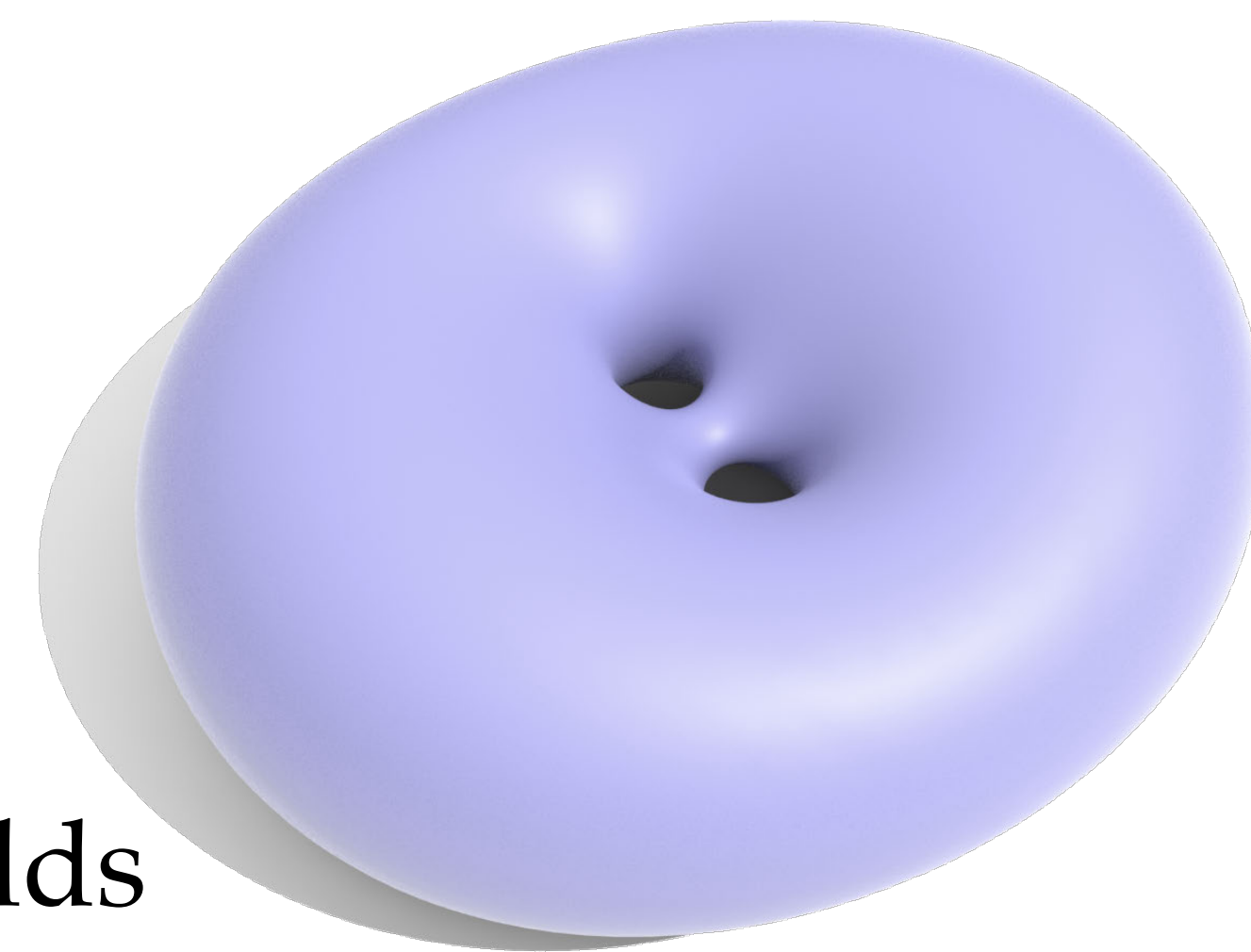

Curves & Surfaces

- Much of the geometry we encounter in life well-described by *curves* and *surfaces**



(Curves)

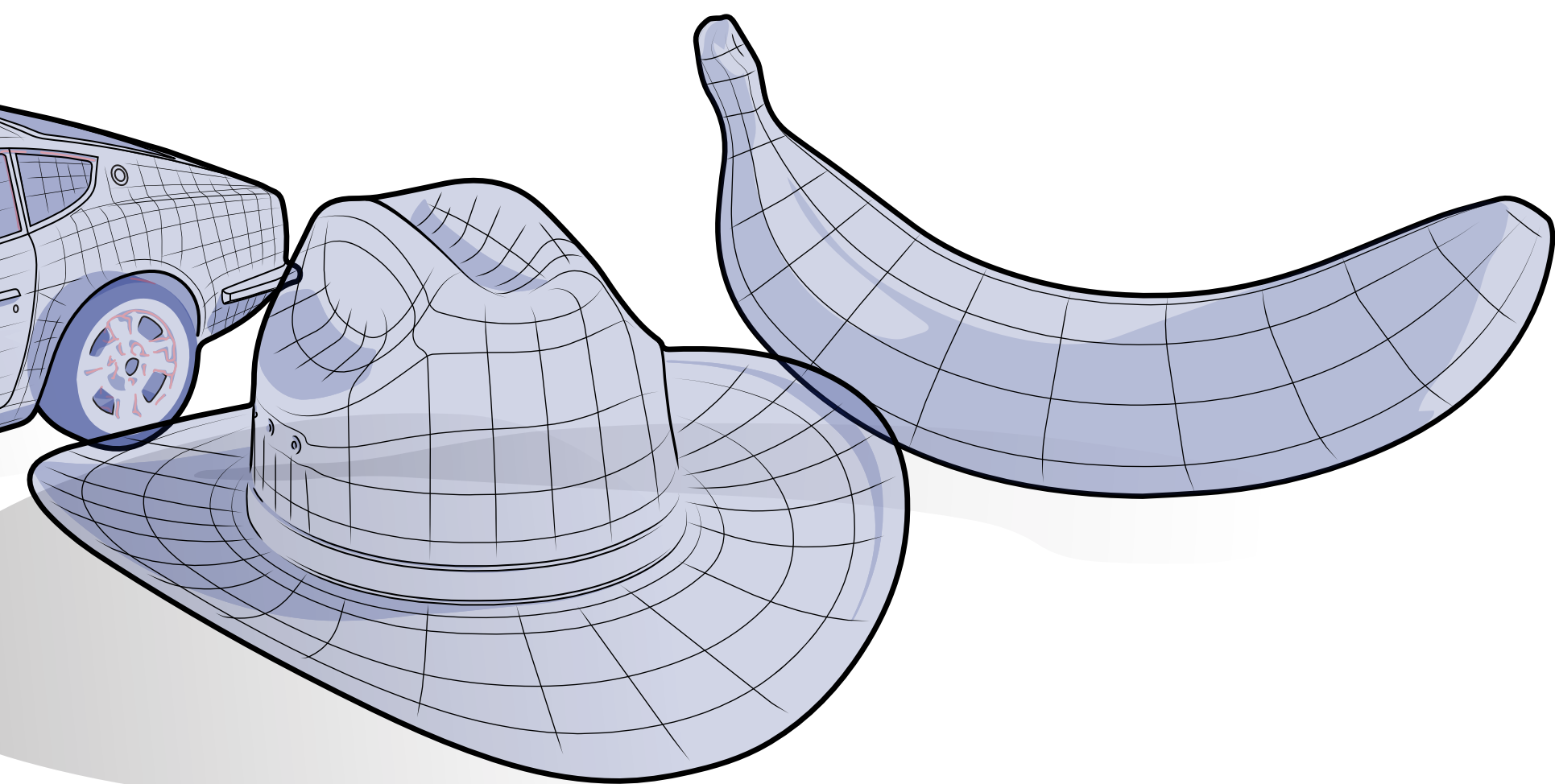
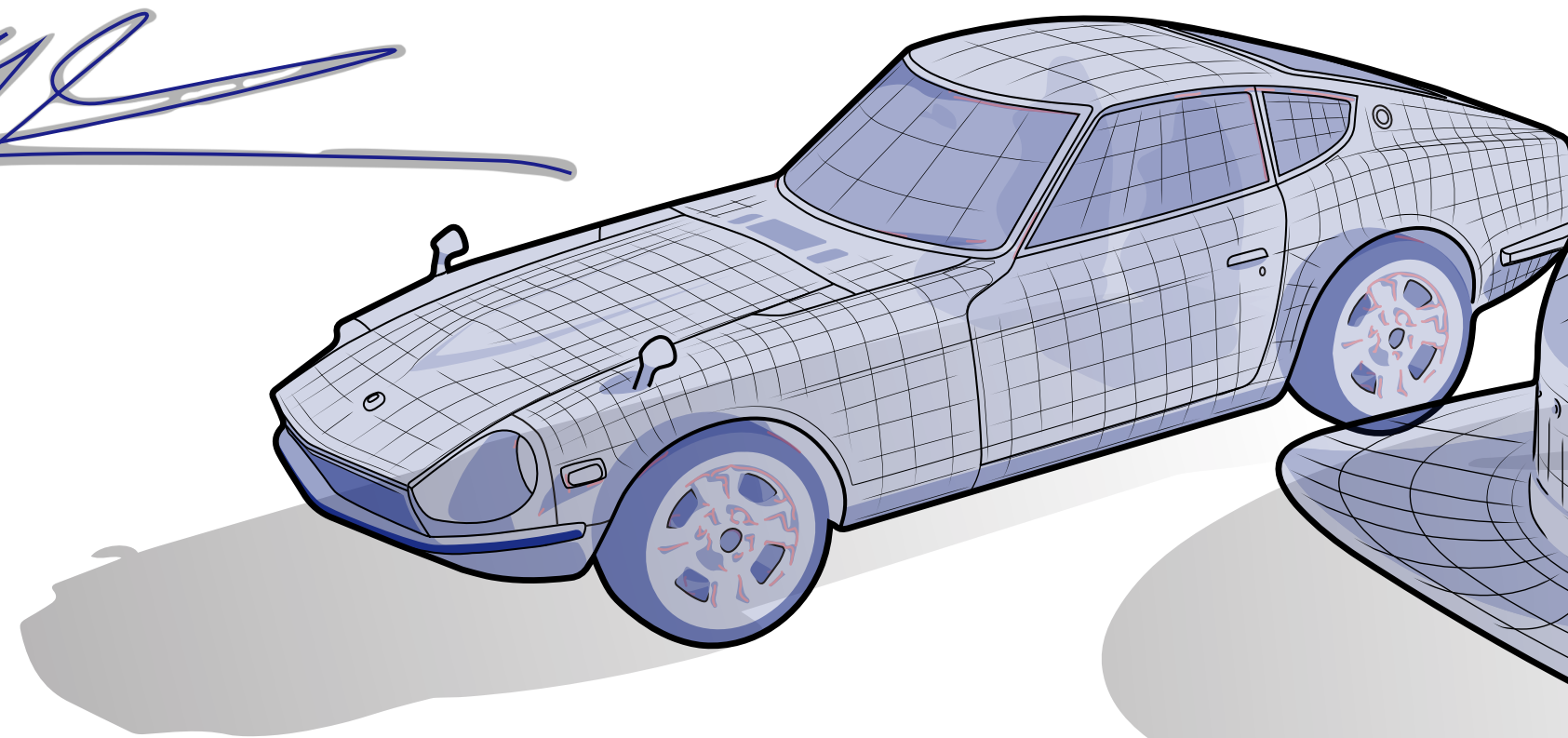

(Surfaces)

*Or solids... but the boundary of a solid is a surface!

Smooth Descriptions of Curves & Surfaces

- Many ways to express the geometry of a curve or surface:

- height function over tangent plane

- local parameterization

- Christoffel symbols — coordinates / indices

- **differential forms** — “coordinate free”

- moving frames — change in *adapted frame*

- Riemann surfaces (*local*); Quaternionic functions (*global*)

- People can get very religious about these different “dialects” ... best to be multilingual!

- We'll dive deep into one description (**differential forms**) and touch on others

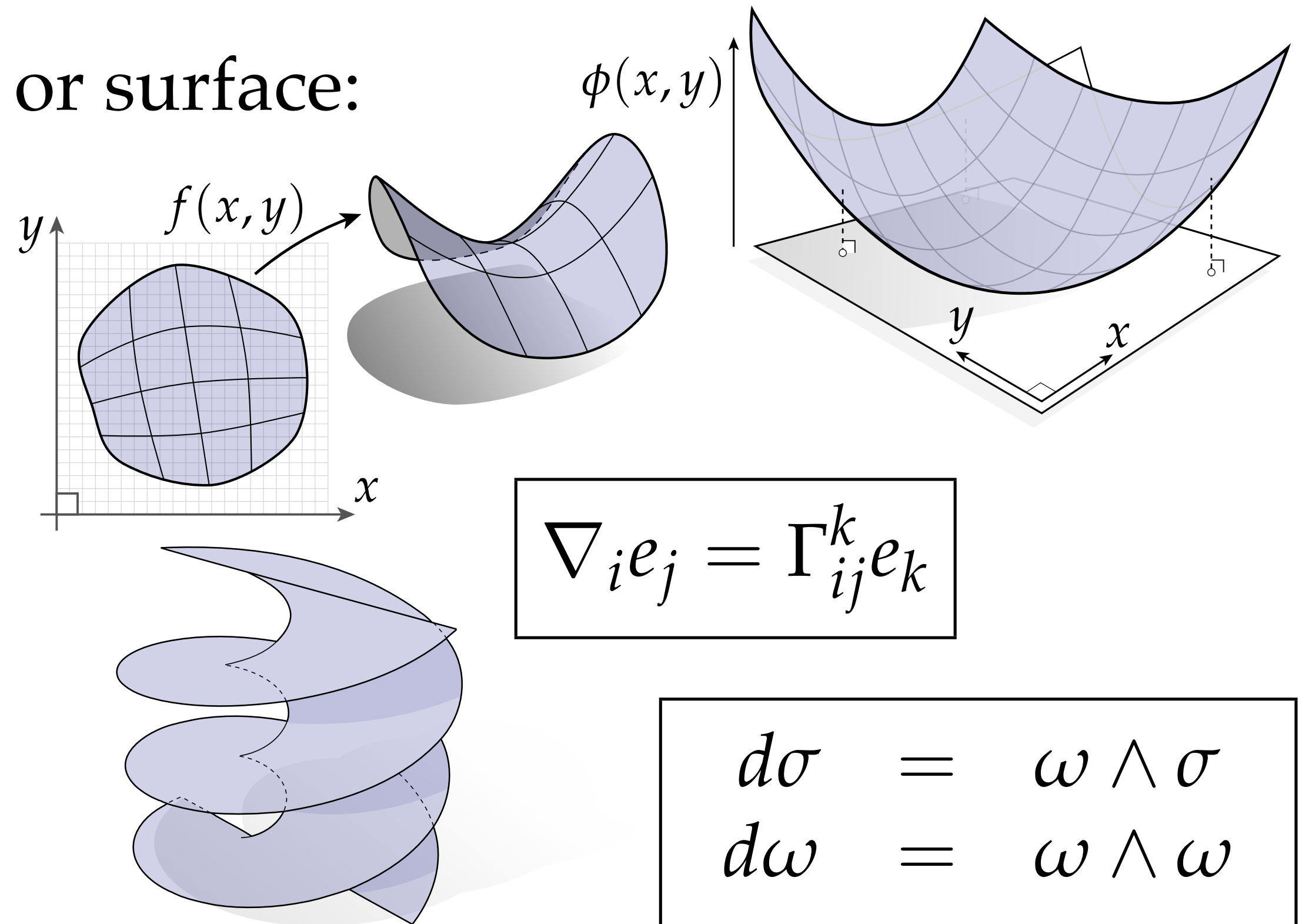

Discrete Descriptions of Curves & Surfaces

- Also *many* ways to discretize a surface
- For instance:
 - **implicit** — *e.g.*, zero set of scalar function on a grid
 - good for changing topology, high accuracy
 - expensive to store / adaptivity is harder
 - hard to solve sophisticated equations *on* surface
 - **explicit** — *e.g.*, polygonal surface mesh
 - changing topology, high-order continuity is harder
 - cheaper to store / adaptivity is much easier
 - more mature tools for equations *on* surfaces
- Don't be “religious”; use the right tool for the job!

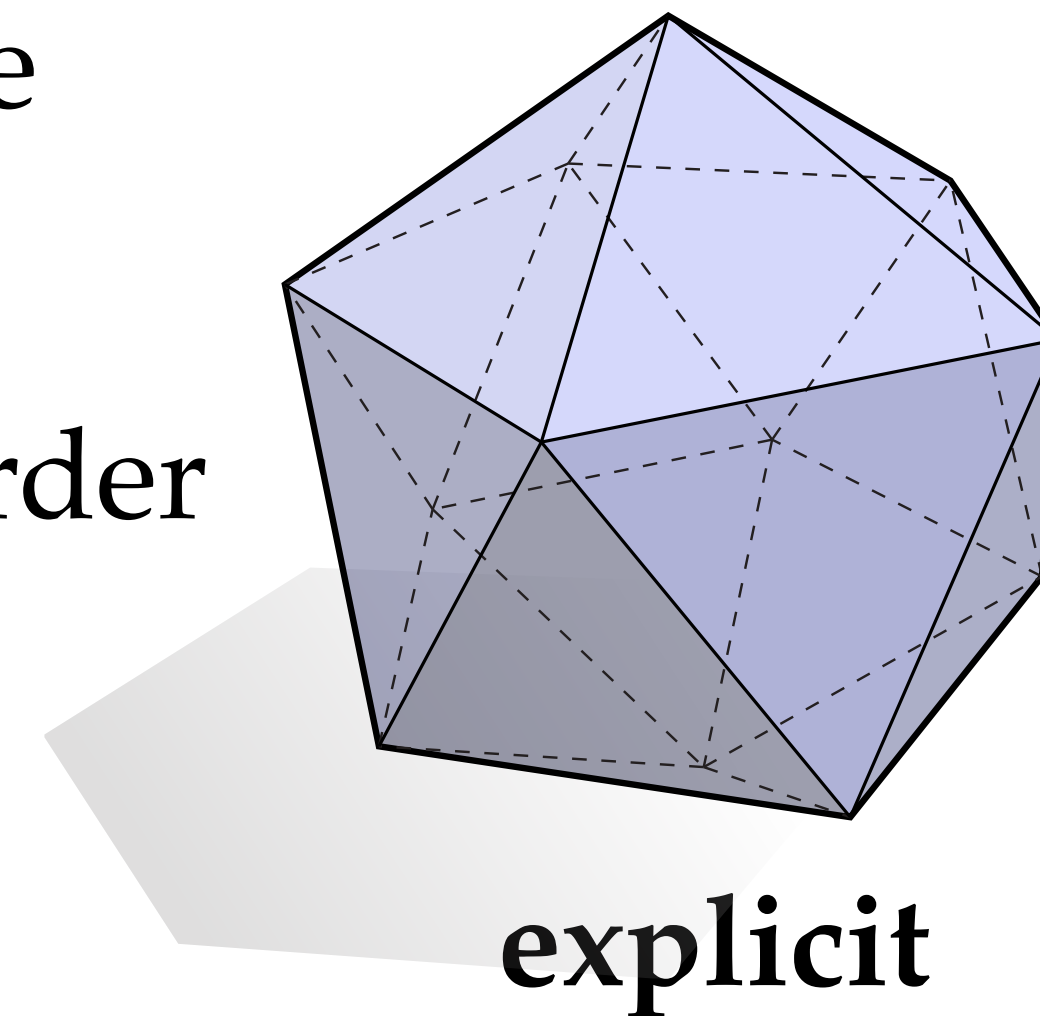
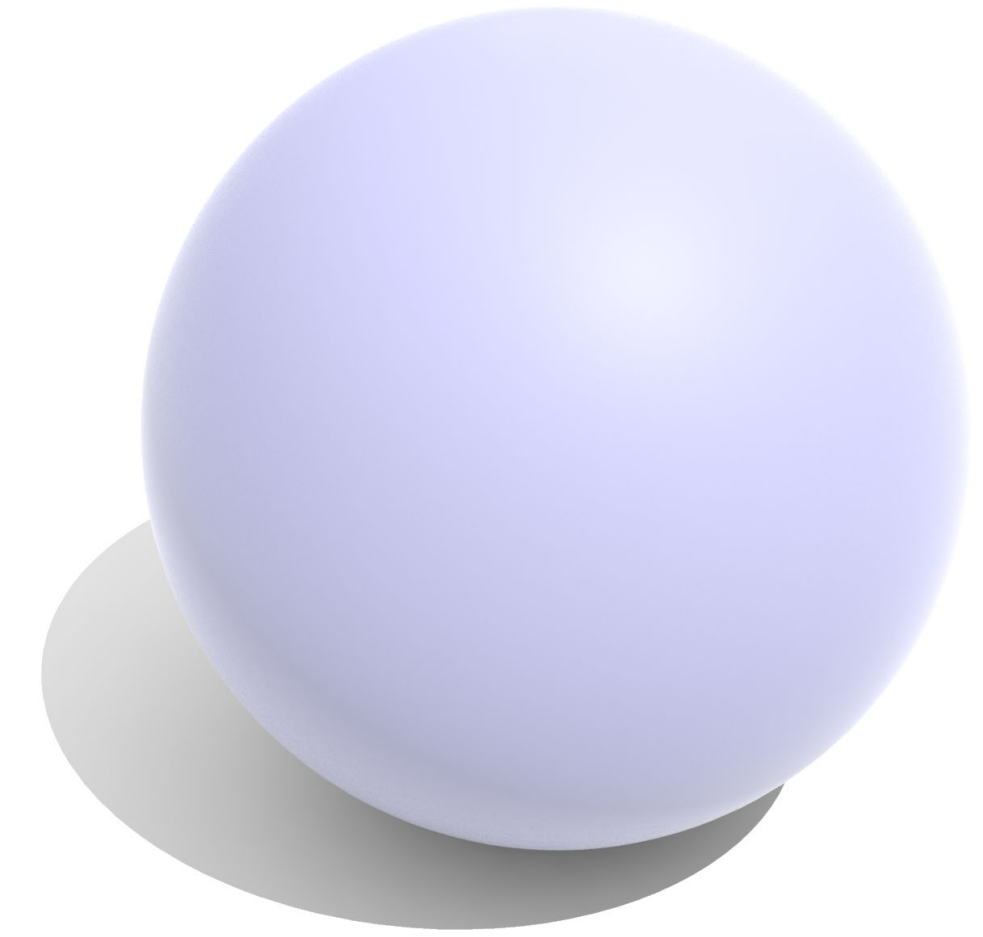

explicit

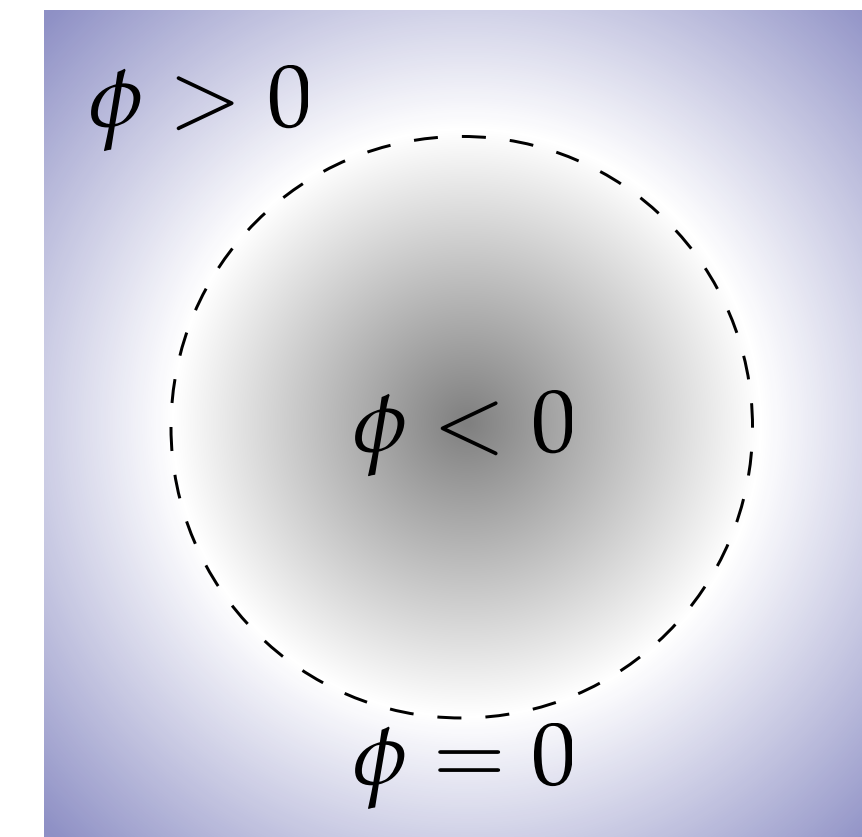

implicit

Curves & Surfaces — Overview

- **Goal:** understand curves & surfaces from complementary smooth and discrete points of view.
- **Smooth setting:**
 - express geometry via differential forms
 - will first need to think about *vector-valued* forms
- **Discrete setting:**
 - use explicit mesh as domain
 - express geometry via discrete differential forms
- **Payoff:** will become very easy to switch back & forth between smooth setting (*scribbling in a notebook*) and discrete setting (*running algorithms on real data!*)

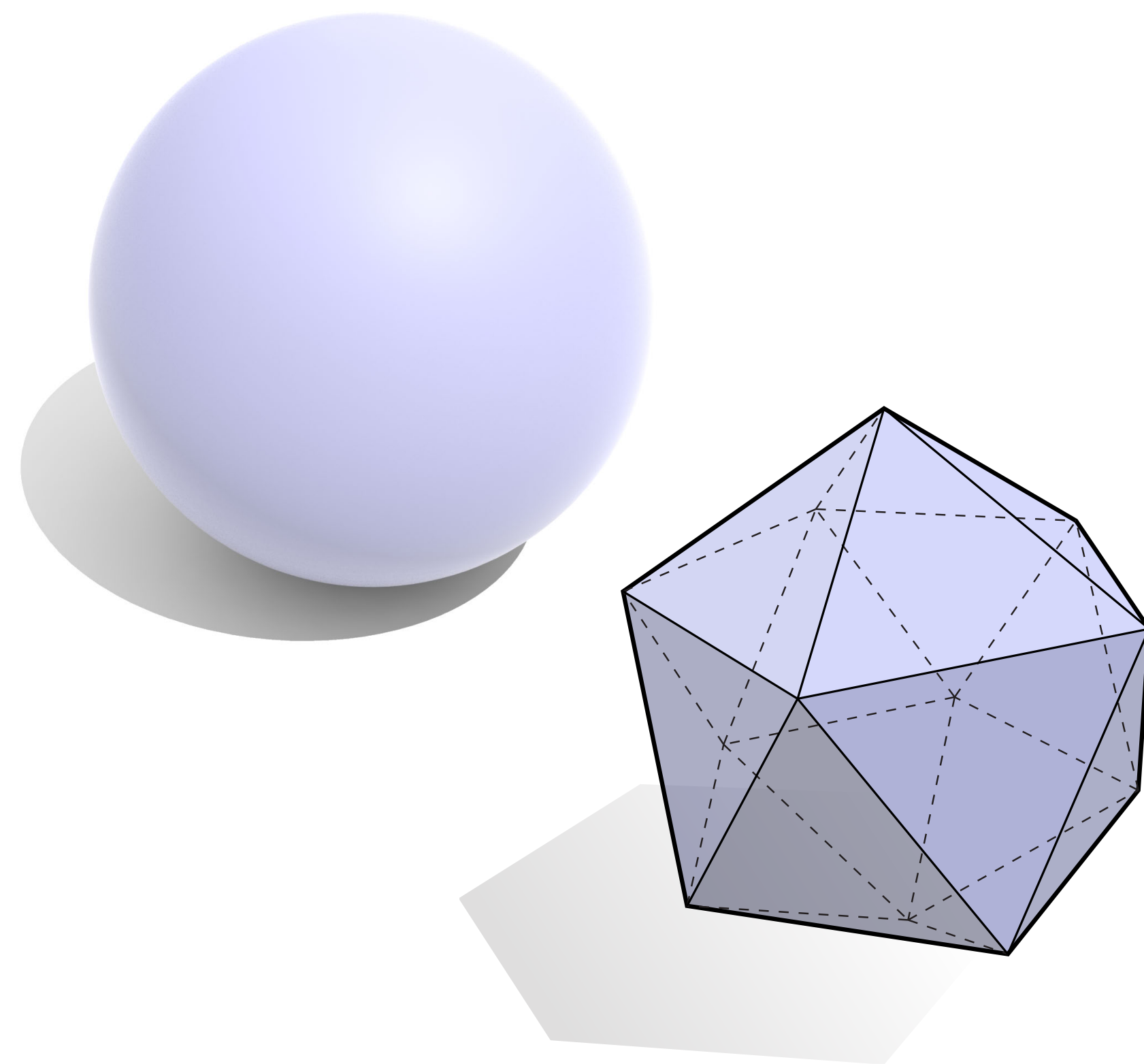



Discrete Curves

Discrete Curves in the Plane

- We'll define a **discrete curve** as a *piecewise linear* parameterized curve, *i.e.*, a sequence of points connected by straight line segments:

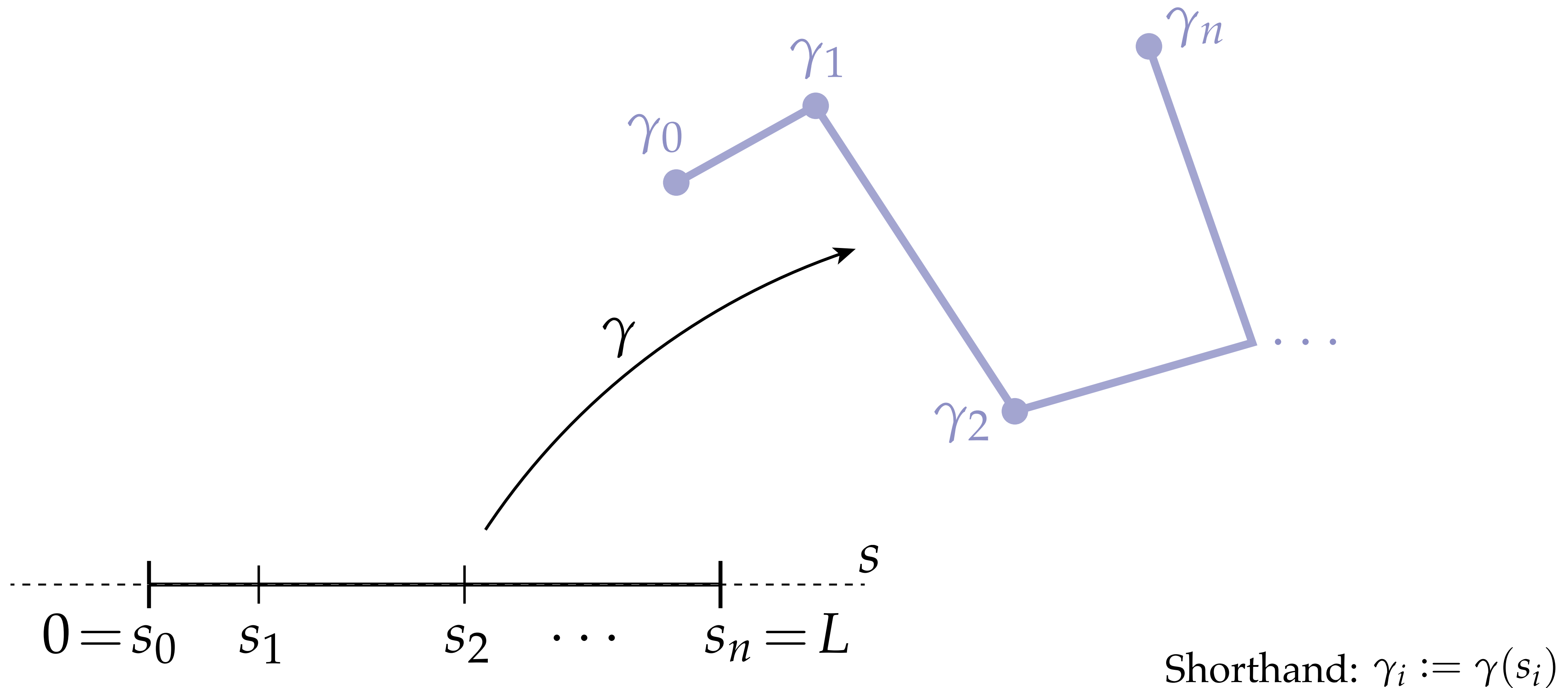

Discrete Curves in the Plane—Example

- A simple example is a curve comprised of two segments:

$$\gamma(s) := \begin{cases} (s, 0), & 0 \leq s \leq 1, \\ (1, s - 1), & 1 \leq s \leq 2 \end{cases}$$

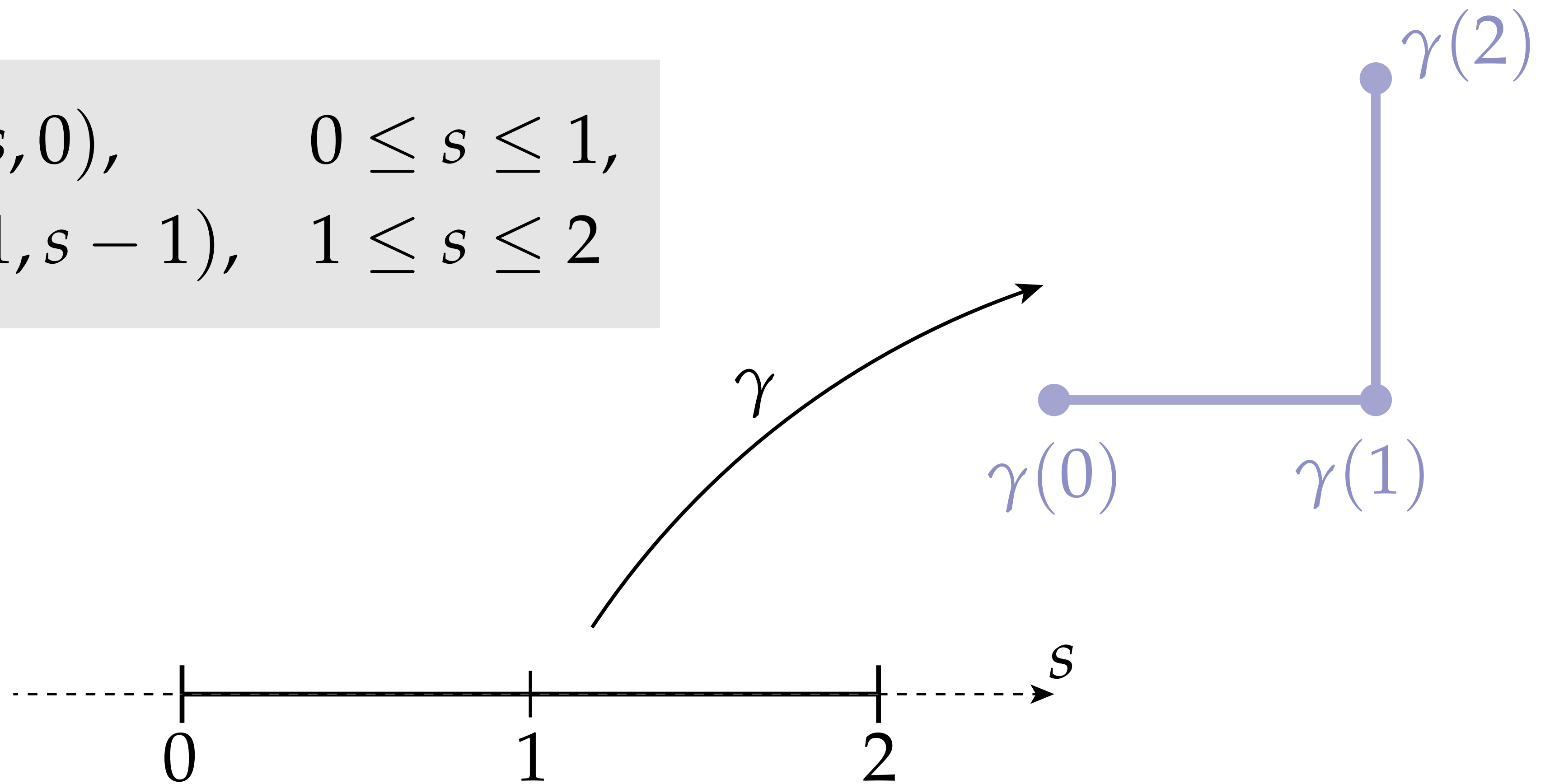

Discrete Curves and Discrete Differential Forms

- Equivalently, a discrete curve is determined by a discrete, R^n -valued 0-form on a manifold simplicial 1-complex
- The 0-form values give the location of the vertices; interpolation by Whitney bases (hat functions) gives the map from each edge to R^n

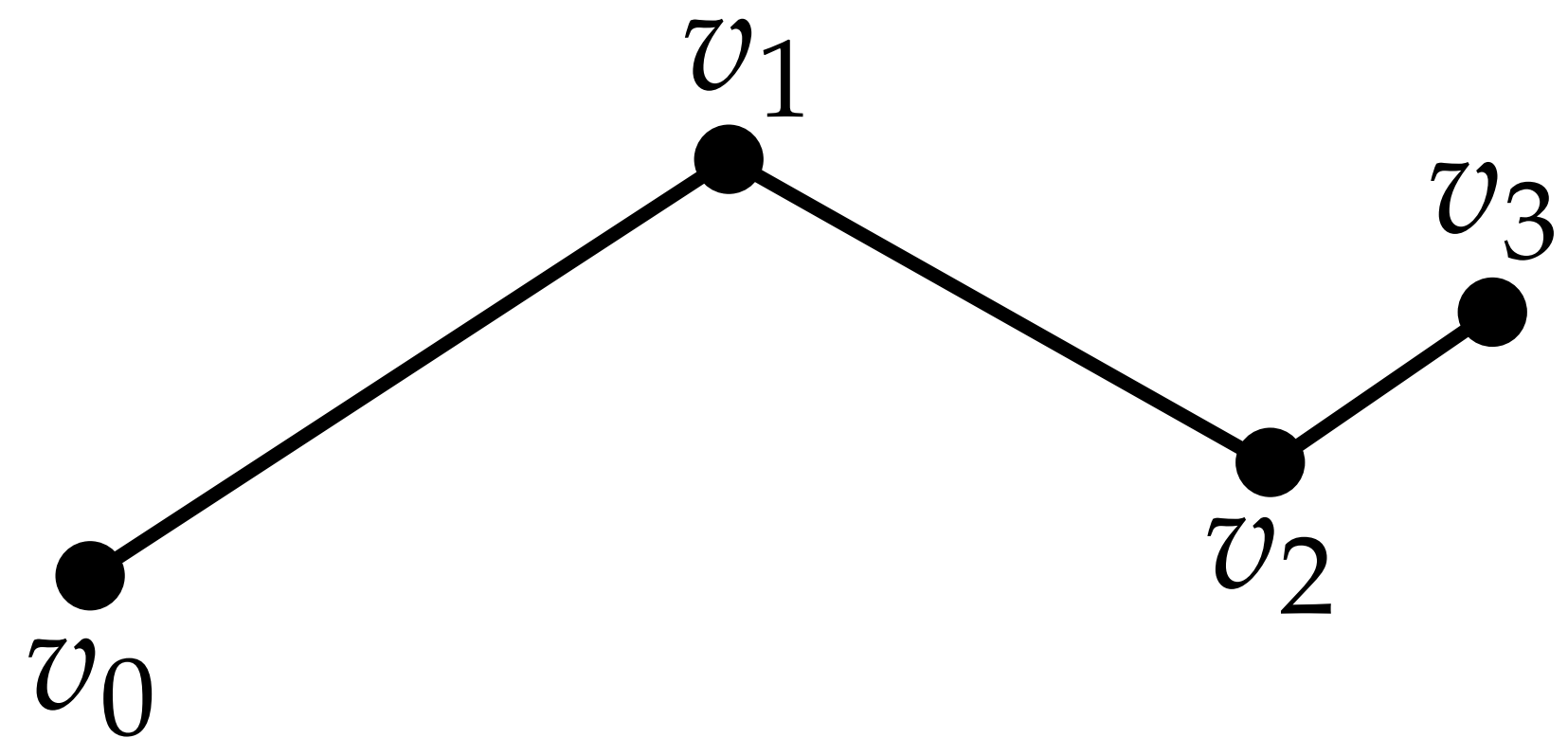

$$K = \{ (v_0, v_1), (v_1, v_2), (v_2, v_3), (v_0), (v_1), (v_2), (v_3), \emptyset \}$$

$$\begin{aligned} \gamma(v_0) &= (33, 66) \\ \gamma(v_1) &= (79, 36) \\ \gamma(v_2) &= (118, 58) \\ \gamma(v_3) &= (134, 47) \end{aligned}$$

Differential of a Discrete Curve

- We can now directly translate statements about **smooth** curves expressed via **smooth** exterior calculus into statements about **discrete** curves expressed using **discrete** exterior calculus
- Simple example: the *differential* just becomes the edge vectors:

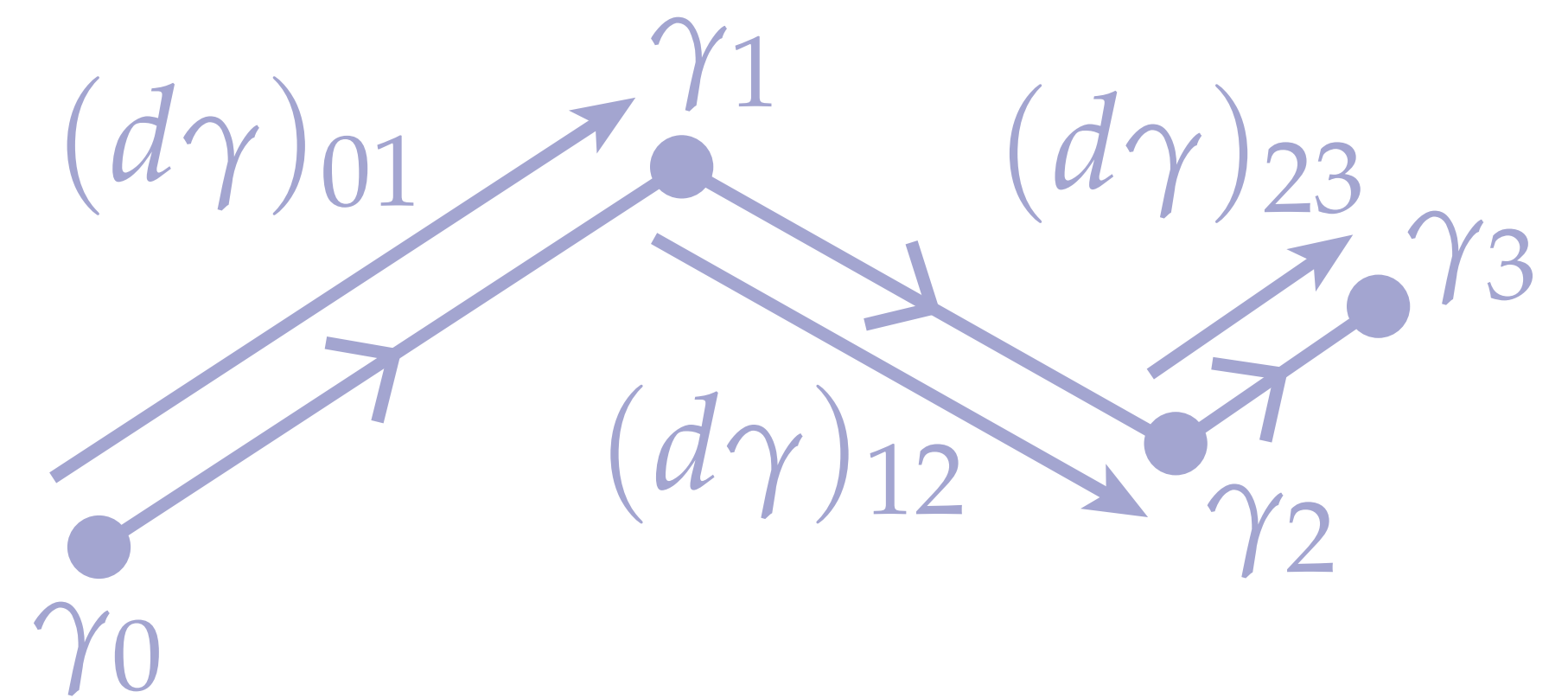
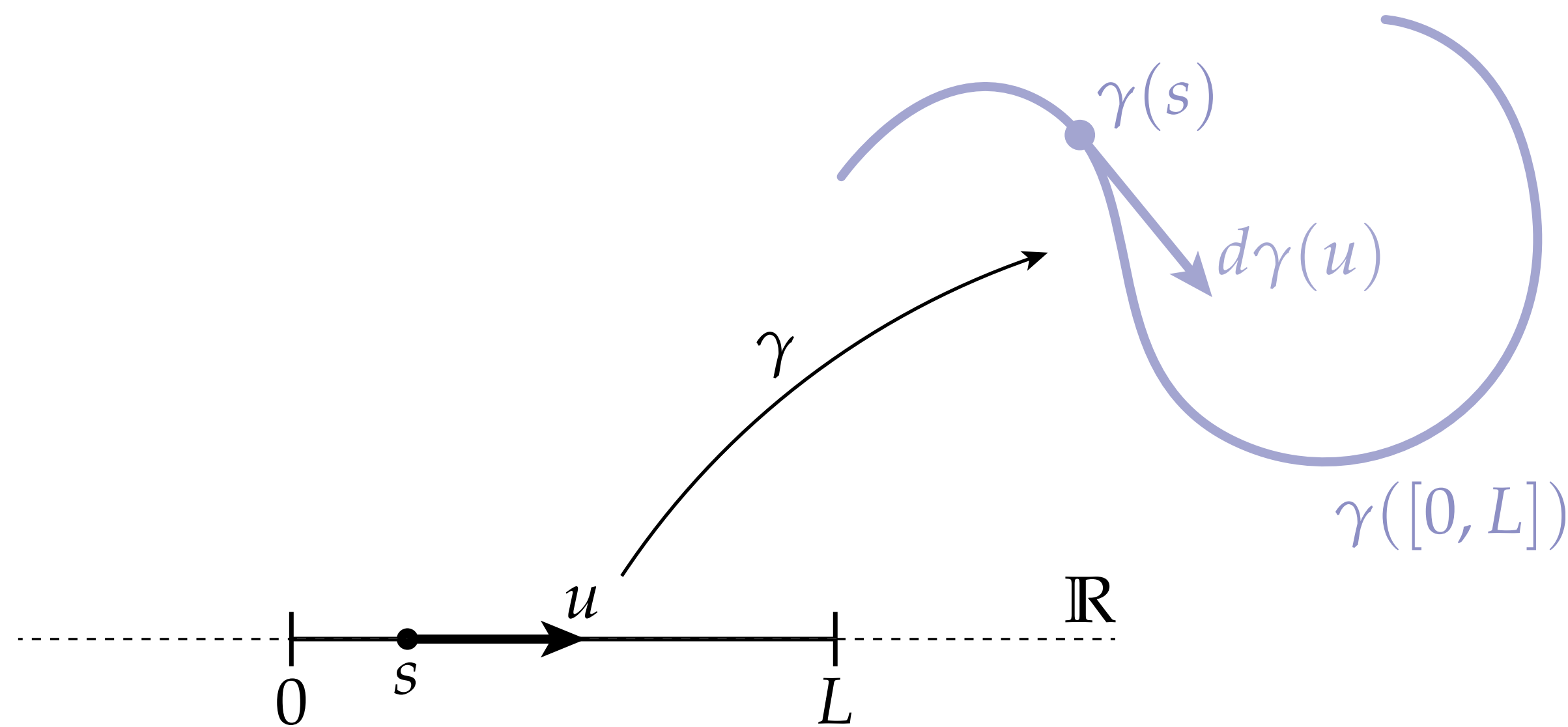

$$(d\gamma)_{ij} = \gamma_j - \gamma_i$$

Discrete Tangent

- As in smooth setting, can simply normalize differential to obtain tangents, yielding a vector per edge*

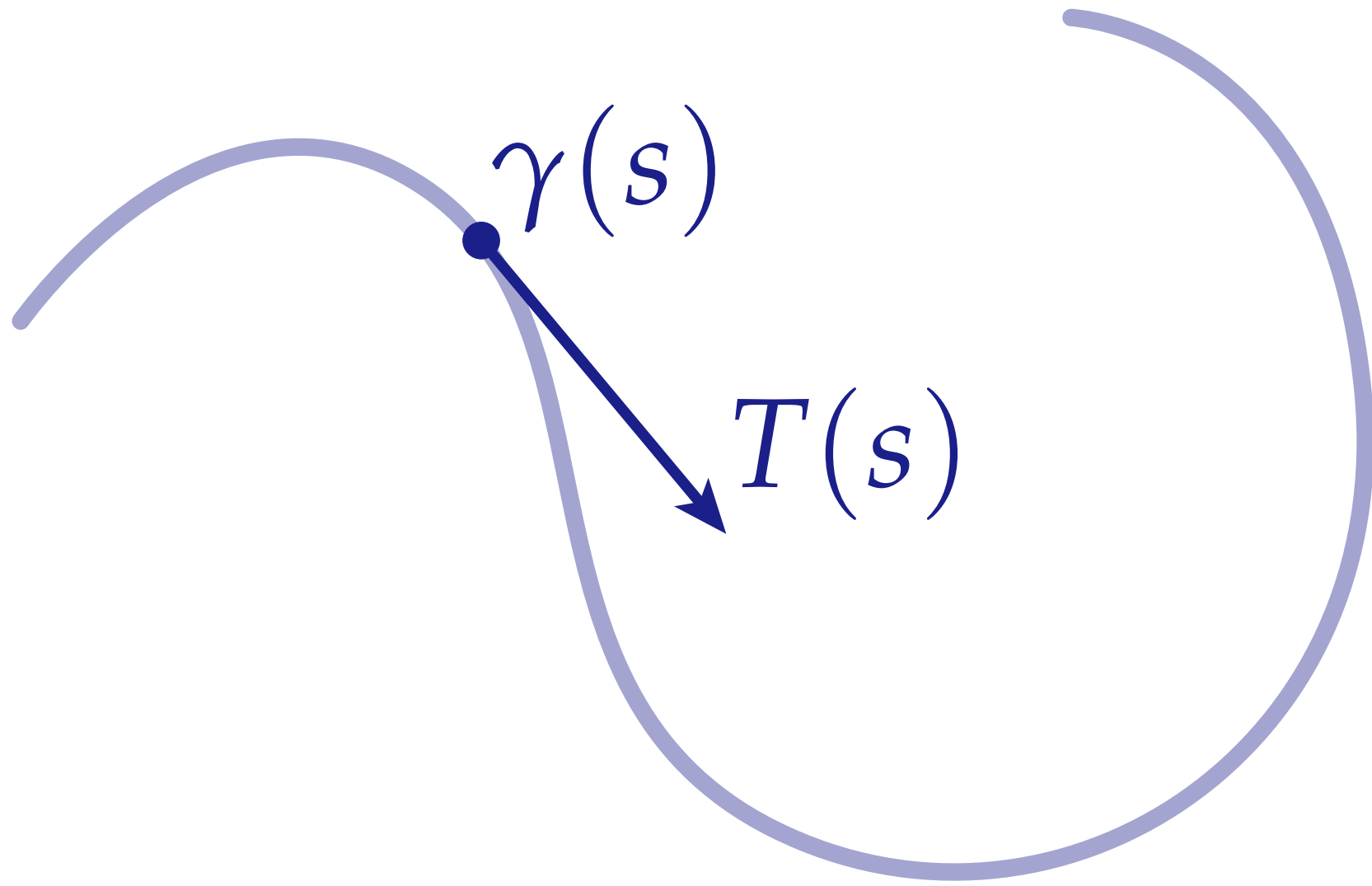

$$T(s) := d\gamma\left(\frac{d}{ds}\right) / \left|d\gamma\left(\frac{d}{ds}\right)\right|$$

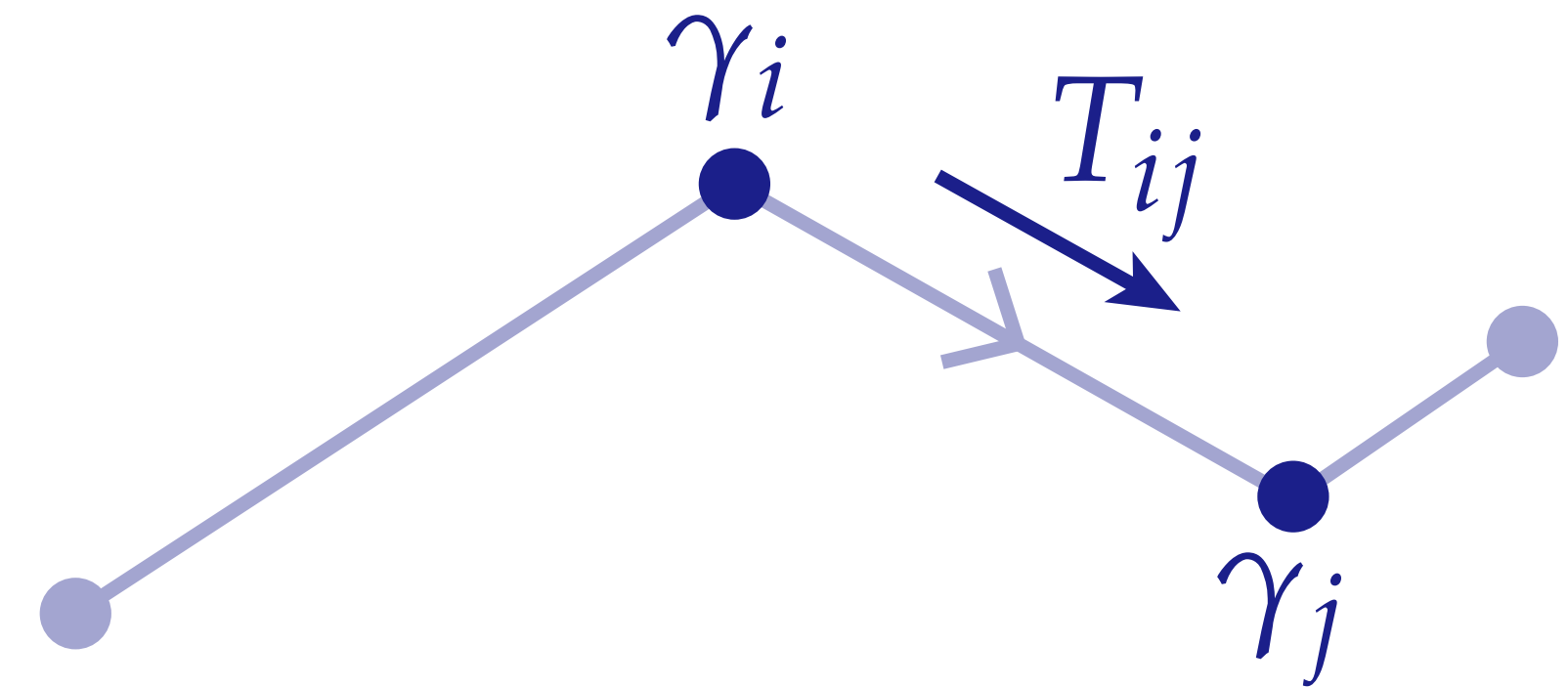

$$T_{ij} := (d\gamma)_{ij} / |(d\gamma)_{ij}|$$

*And no definition of the tangent at vertices!

Discrete Normal

- As in the smooth setting, we can express the (discrete) normals of a planar curve as a 90-degree rotation of the (discrete) tangent:

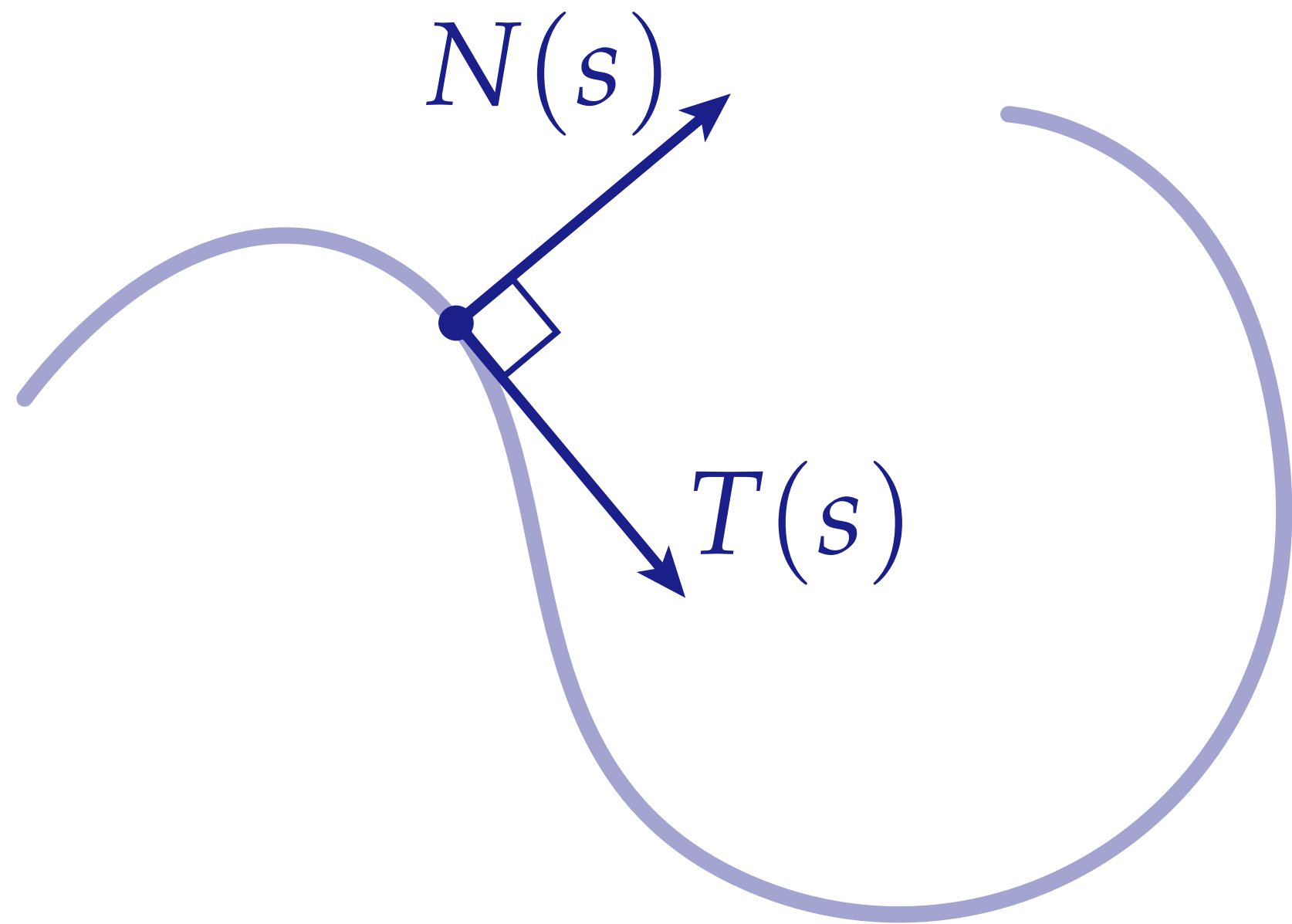

$$N(s) = \mathcal{J}T(s)$$

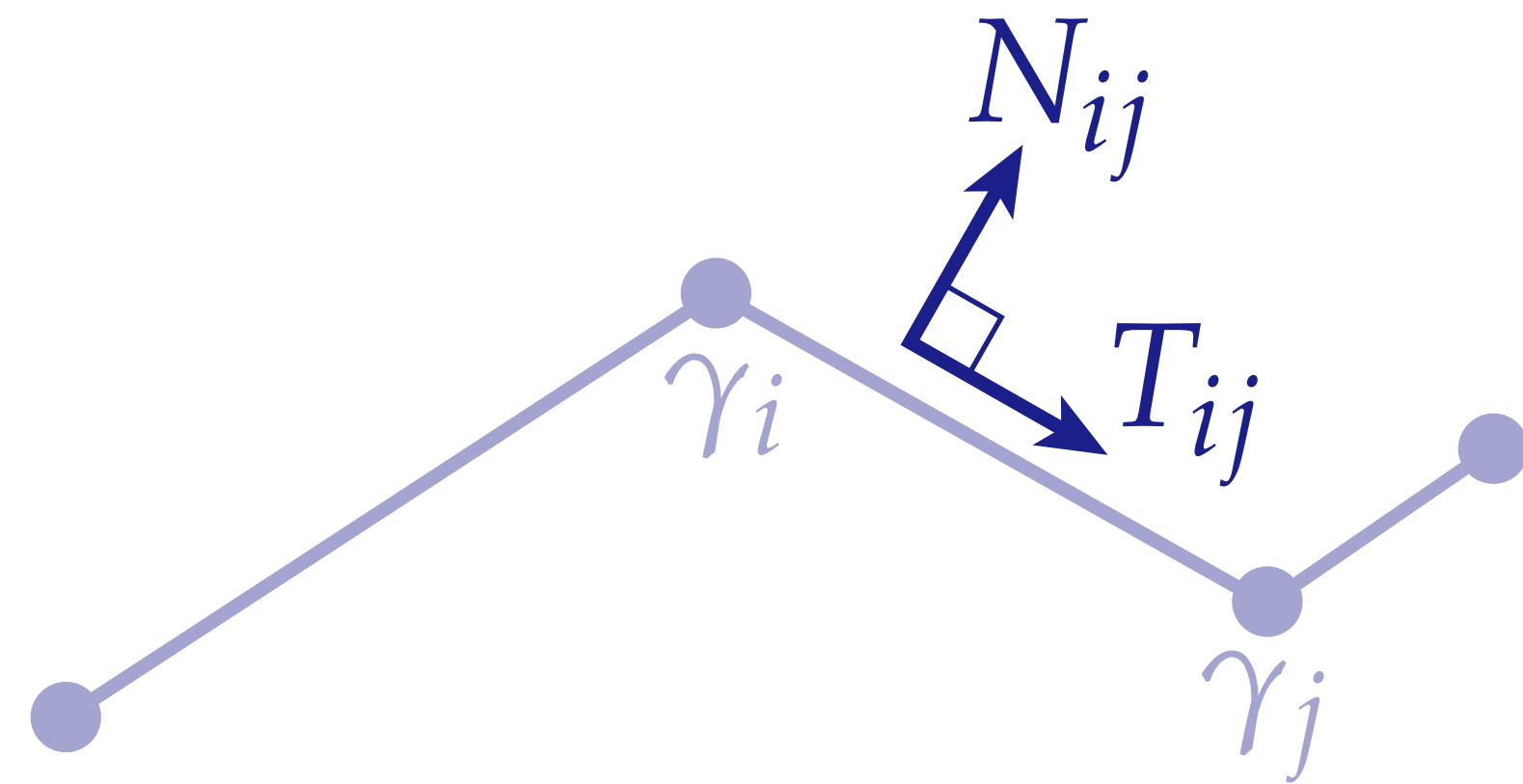

$$N_{ij} = \mathcal{J}T_{ij}$$

Regular Discrete Curve / Discrete Immersion

- Recall that a smooth curve is *regular* if its differential is nonzero; this condition helps avoid “bad behavior” like sharp cusps
- For a discrete curve, a nonzero differential merely prevents zero edge lengths; need something stronger to get “nice” curves
- In particular, a *regular discrete curve* or *discrete immersion* is a discrete curve that is a **locally injective map**
- Rules out zero edge lengths *and* zero angles

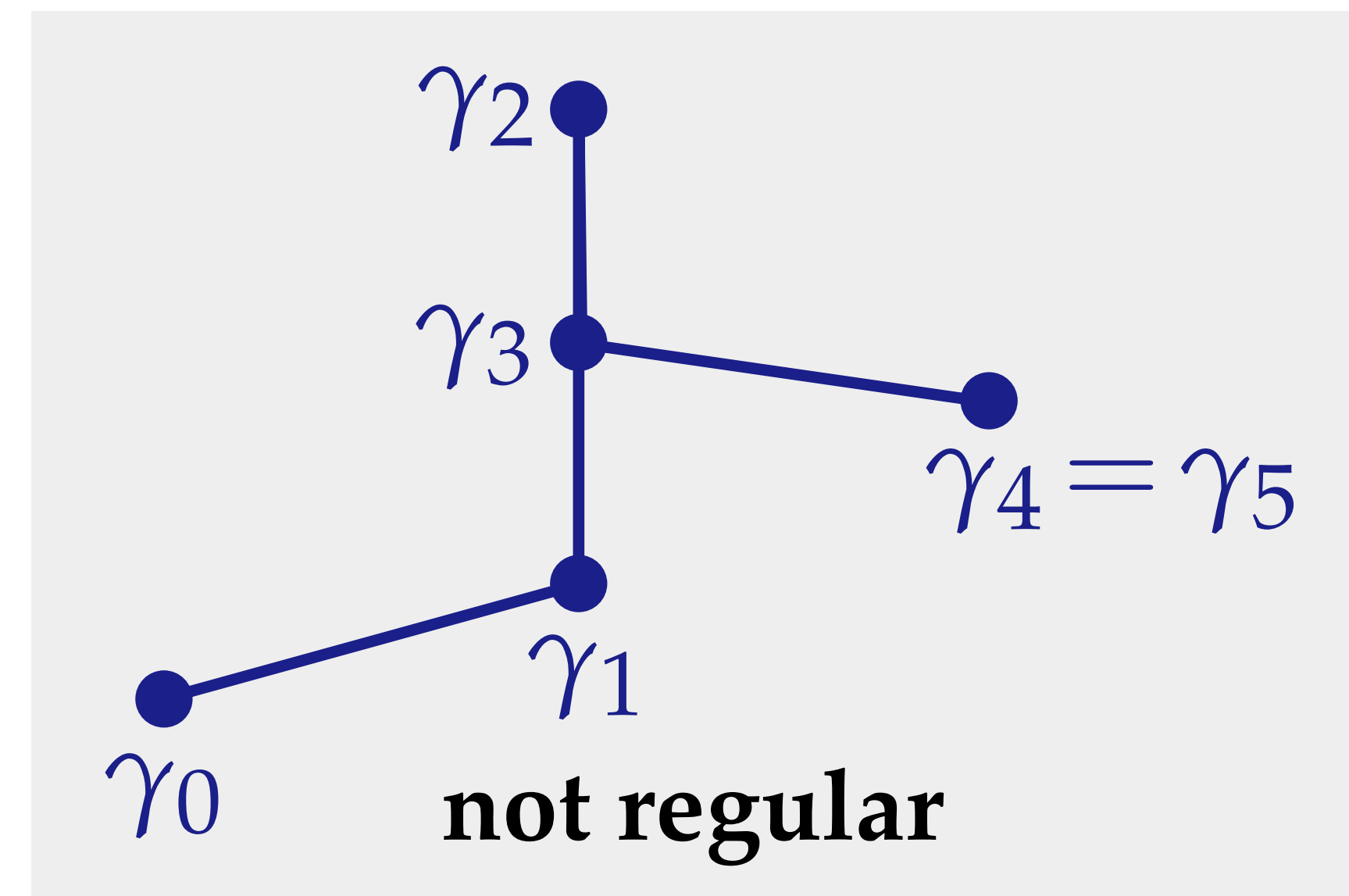
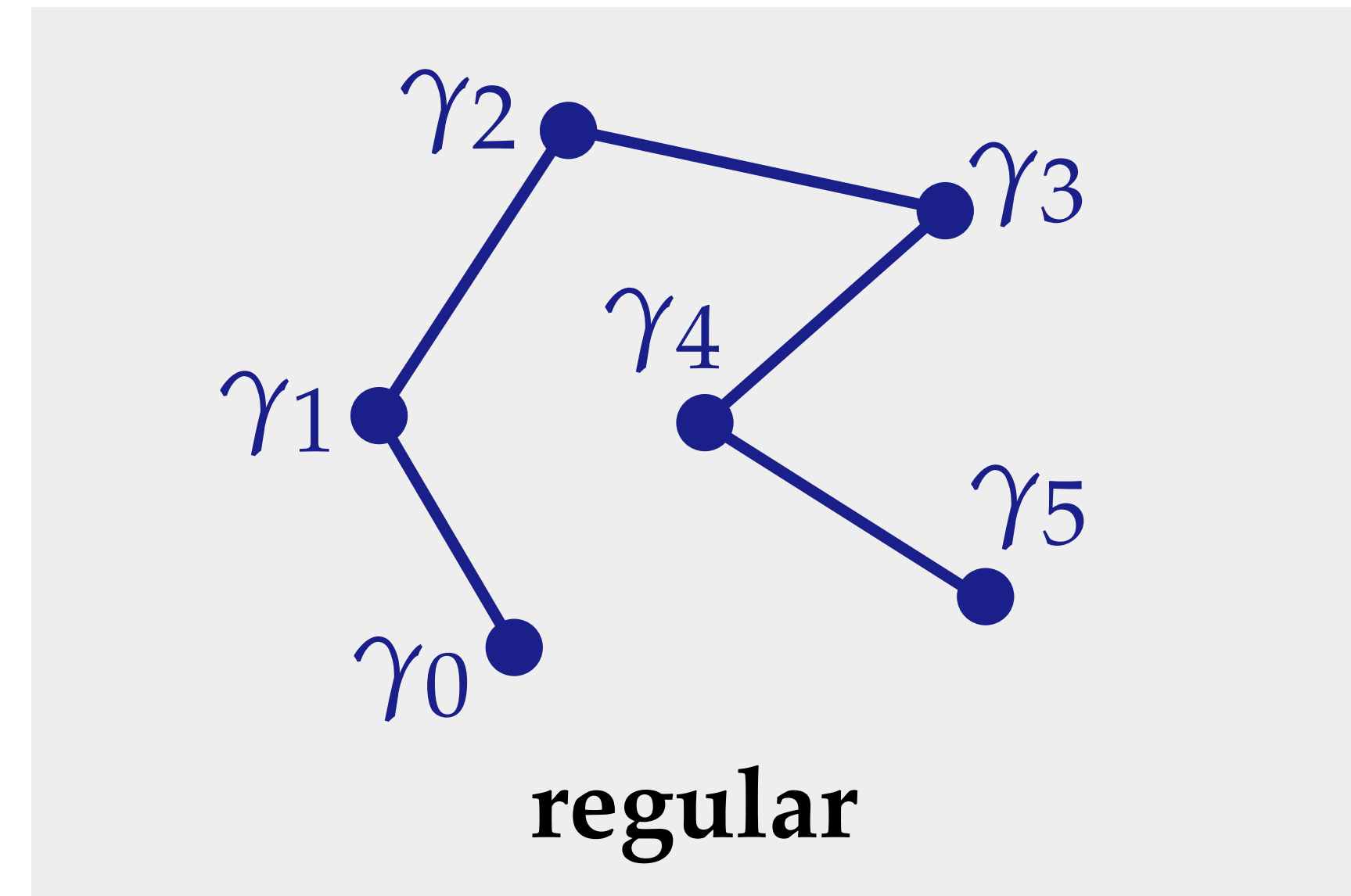

Discrete Curvature

- For a regular discrete curve, discrete curvature has several definitions

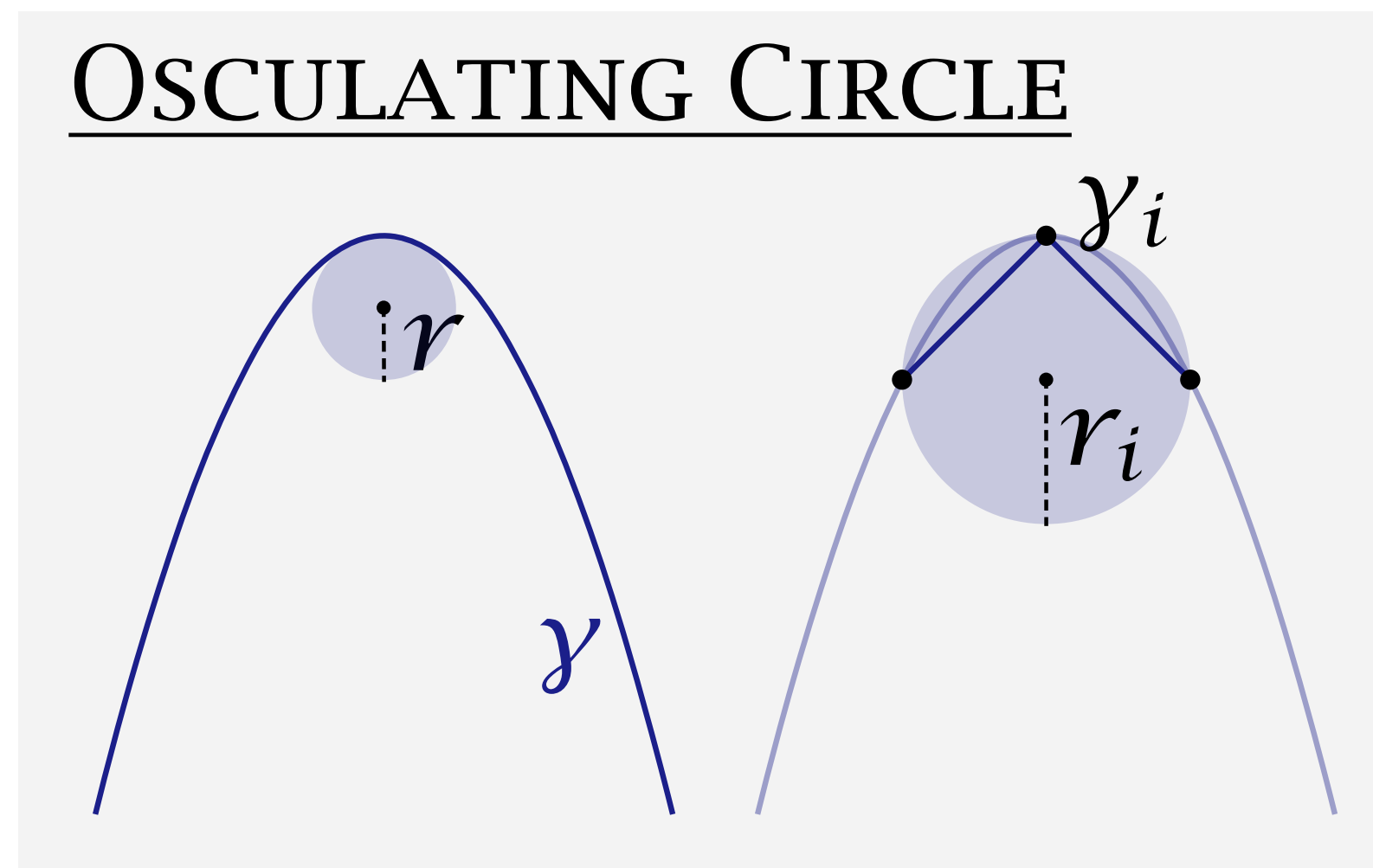
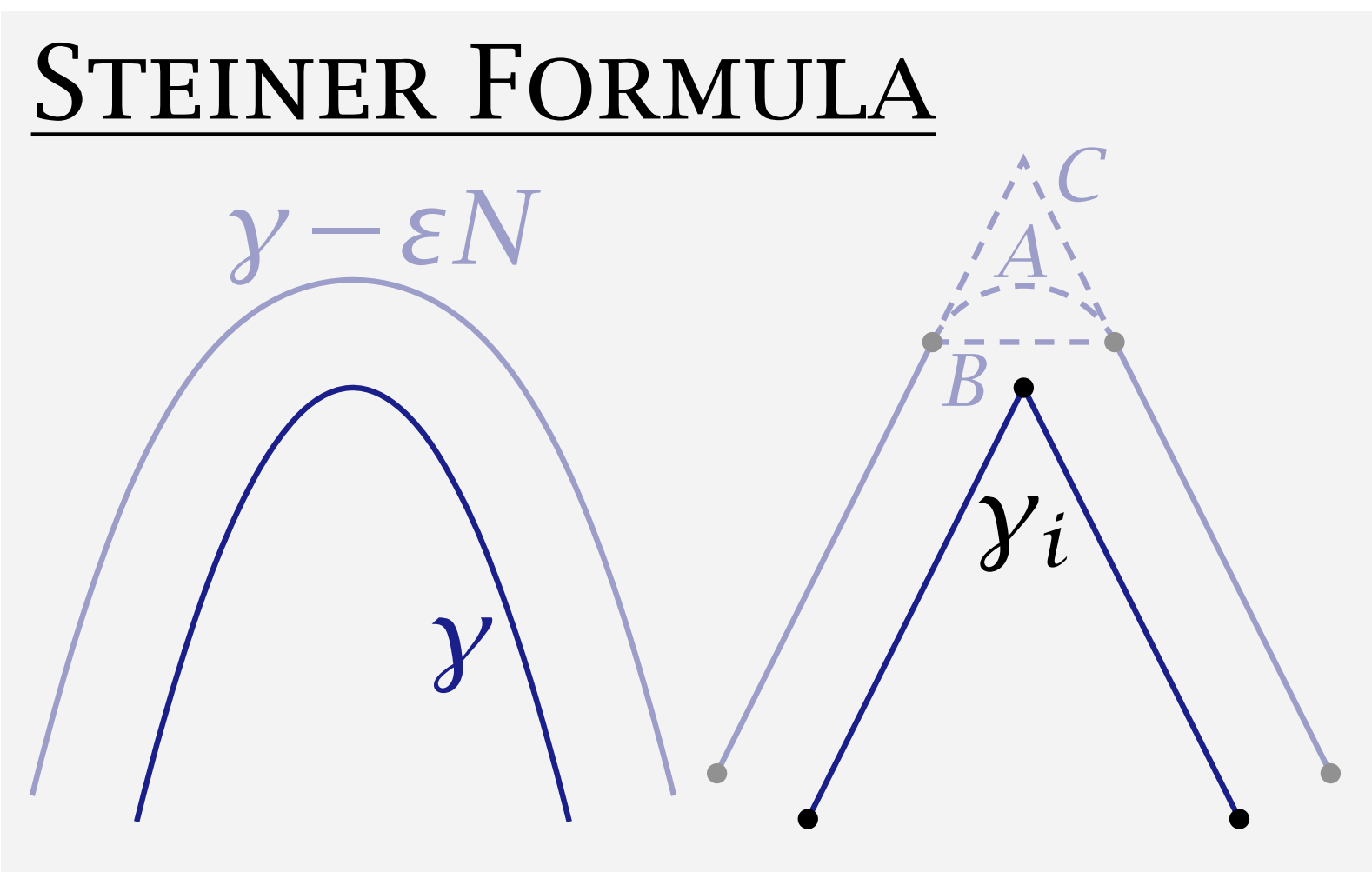
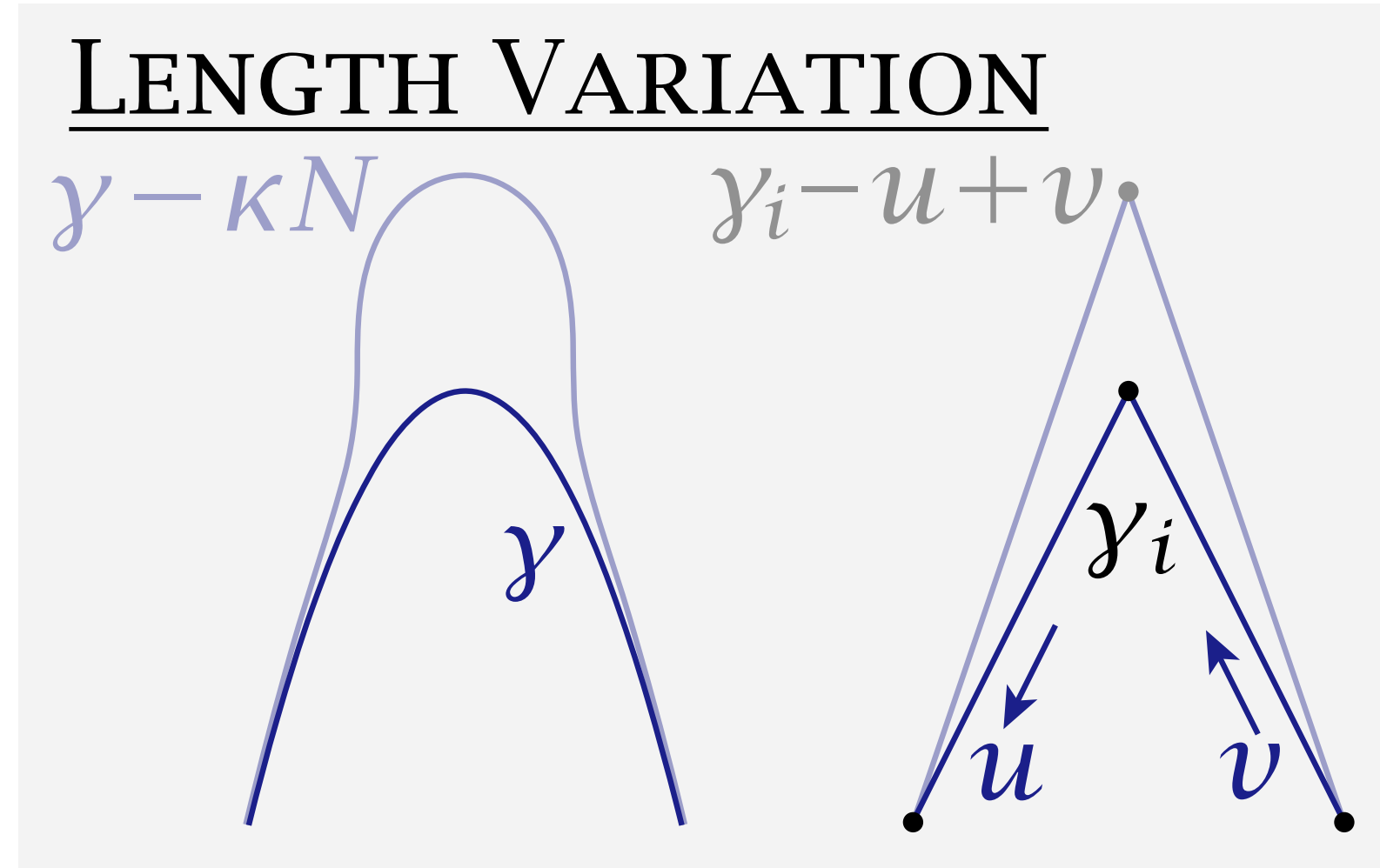
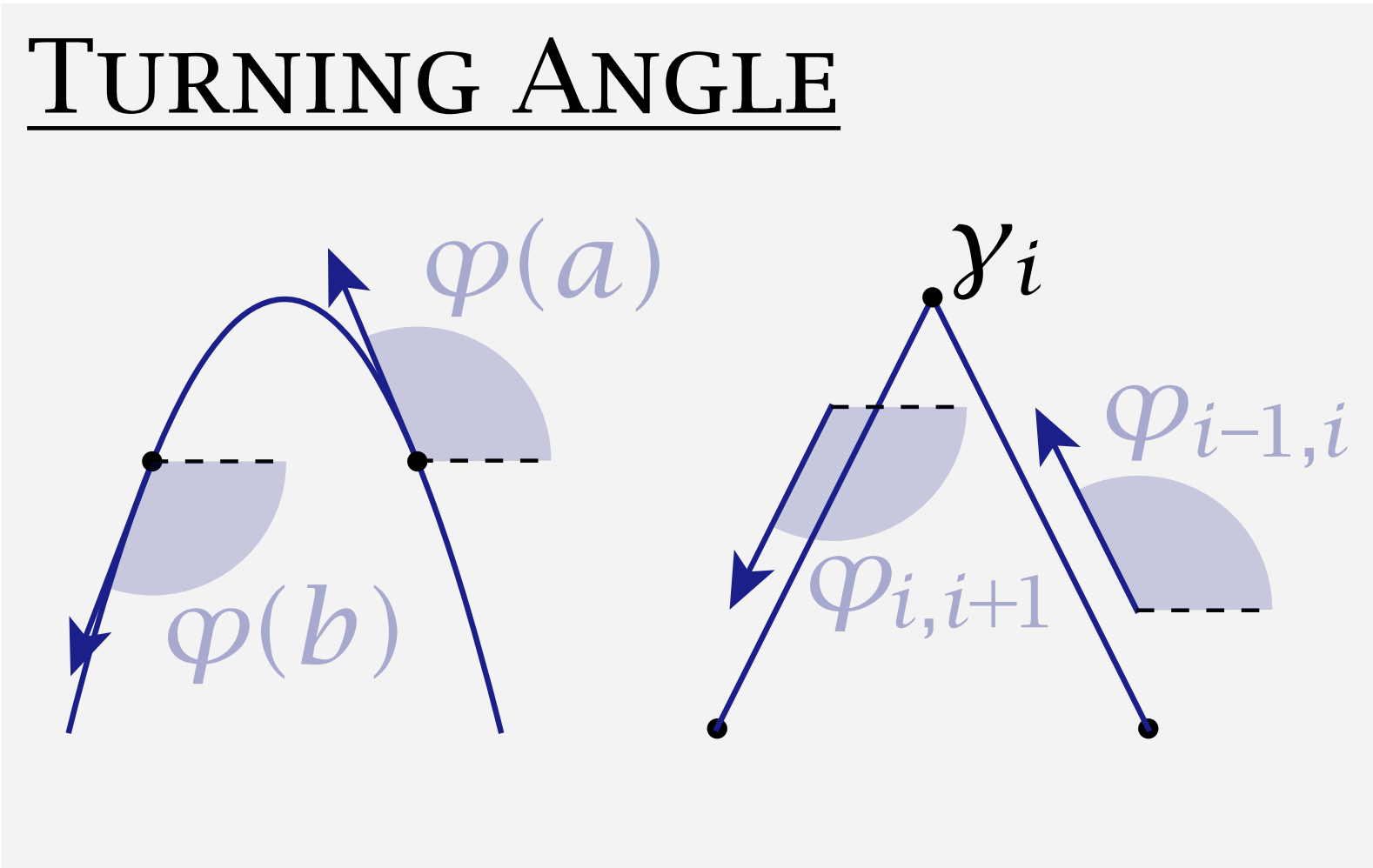

Fundamental Theorem of Discrete Plane Curves

Fact. Up to rigid motions, a regular discrete plane curve is uniquely determined by its edge lengths and turning angles.

Q: Given only this data, how can we recover the curve?

A: Mimic the procedure from the smooth setting:

Sum curvatures to get angles: $\varphi_{i,i+1} := \sum_{k=1}^i \theta_k$

Evaluate unit tangents: $T_{ij} := (\cos(\varphi_{ij}), \sin(\varphi_{ij}))$

Sum tangents to get curve: $\gamma_i := \sum_{k=1}^i \ell_{k,k+1} T_{k,k+1}$

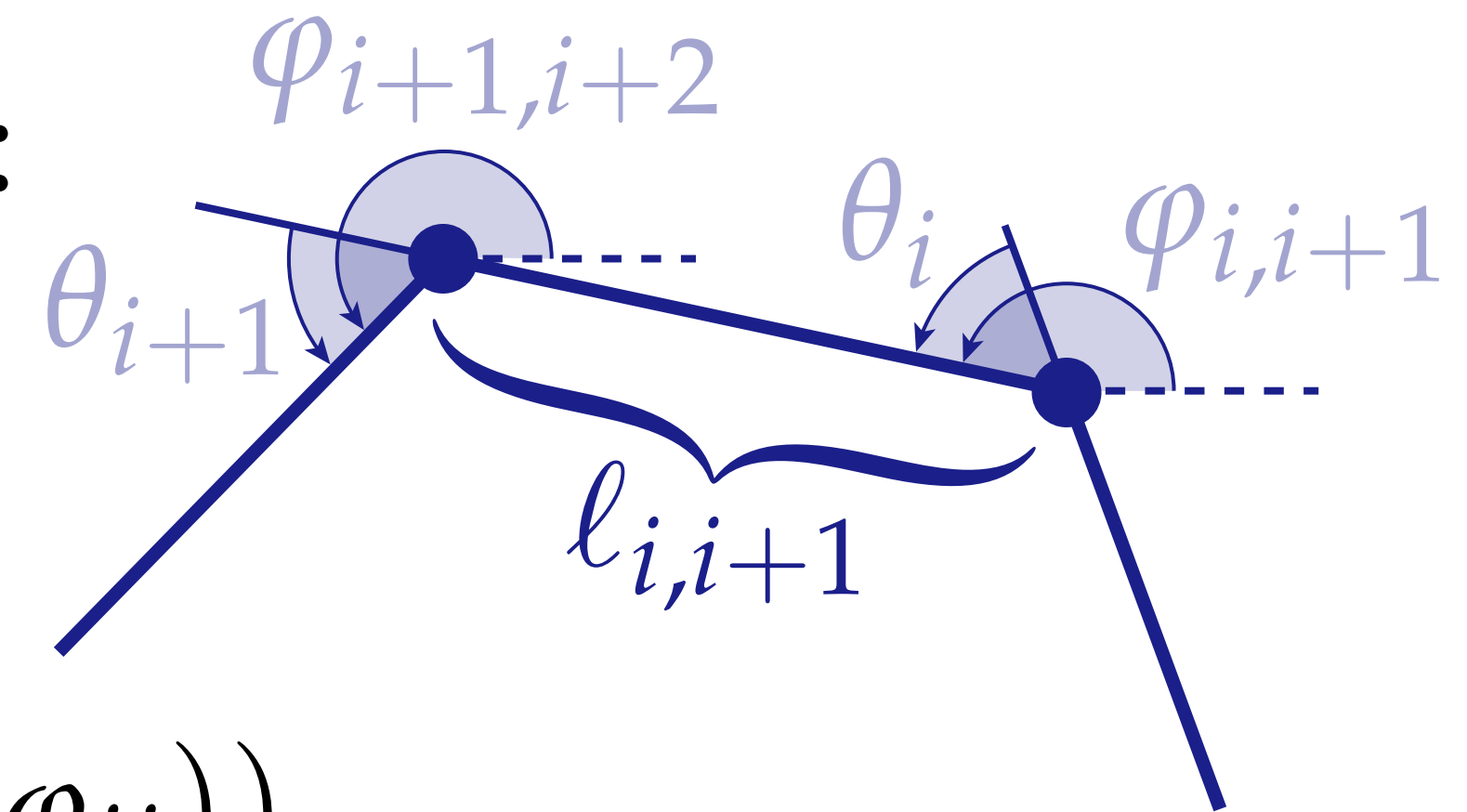

Q: Rigid motions?

Discrete Whitney Graustein

- If we adopt the definition of a discrete regular curve as one that is *locally injective*, then there is a discrete version of Whitney-Graustein that exactly mirrors the smooth one
- Has been carefully studied from several perspectives:
 - Constructive algorithm (case analysis) by Mehlhorn & Yap (1991)
 - Much simpler argument by Pinkall in terms of convex polyhedron: <https://bit.ly/2BFtywA>
- Both use powerful idea from (discrete) differential geometry: to find a “path” connecting two objects, find path from both objects to a canonical one, then compose... (uniformization, Delaunay, ...)

SIAM J. COMPUT.
Vol. 20, No. 4, pp. 603-621, August 1991

© 1991 Society for Industrial and Applied Mathematics
001

**CONSTRUCTIVE WHITNEY-GRAUSTEIN THEORY
OR HOW TO UNTANGLE CLOSED PLANAR
POLYGONS**

KURT MEHLHORN† AND CHEE-KENG YAP

Abstract. The classification of polygons is considered in which two polygons are equivalent if one can be continuously transformed into the other such that for each pair of adjacent edges overlap. A discrete analogue of the classic Whitney-Graustein theorem is proved that the winding number of polygons is a complete invariant for this classification. An algorithm is given that is constructive in that for any pair of equivalent polygons, it produces some sequence of transformations taking one polygon to the other. Although this sequence has a quadratic number of steps, it can be described and computed in real time.

Key words. polygons, computational algebraic topology, computational geometry, Whitney-Graustein theorem, winding number

The Discrete Whitney-Graustein Theorem

[Leave a reply.](#)

Let us consider regular closed discrete plane curves γ with n vertices and tangent winding number m . We assume that the length of γ is normalized to some arbitrary (but henceforth fixed) constant L . Up to orientation-preserving rigid motions such a γ is uniquely determined by a point

$$(\ell_1, \dots, \ell_n, \kappa_1, \dots, \kappa_n) \in (0, \infty)^n \times (-\pi, \pi)^n$$

satisfying

$$\ell_1 + \dots + \ell_n = L$$

$$\kappa_1 + \dots + \kappa_n = 2\pi m$$

$$\ell_1 e^{i\alpha_1} + \dots + \ell_n e^{i\alpha_n} = 0$$

where

$$\alpha_j = \kappa_1 + \dots + \kappa_j.$$

Proposition 1: Consider a fixed $(\kappa_1, \dots, \kappa_n) \in \times (-\pi, \pi)^n$ satisfying $\kappa_1 + \dots + \kappa_n = 2\pi m$ for some $m \in \mathbb{Z}$ and define $\alpha_1, \dots, \alpha_n$ as above. Then the set of $(\ell_1, \dots, \ell_n) \in (0, \infty)^n$ satisfying

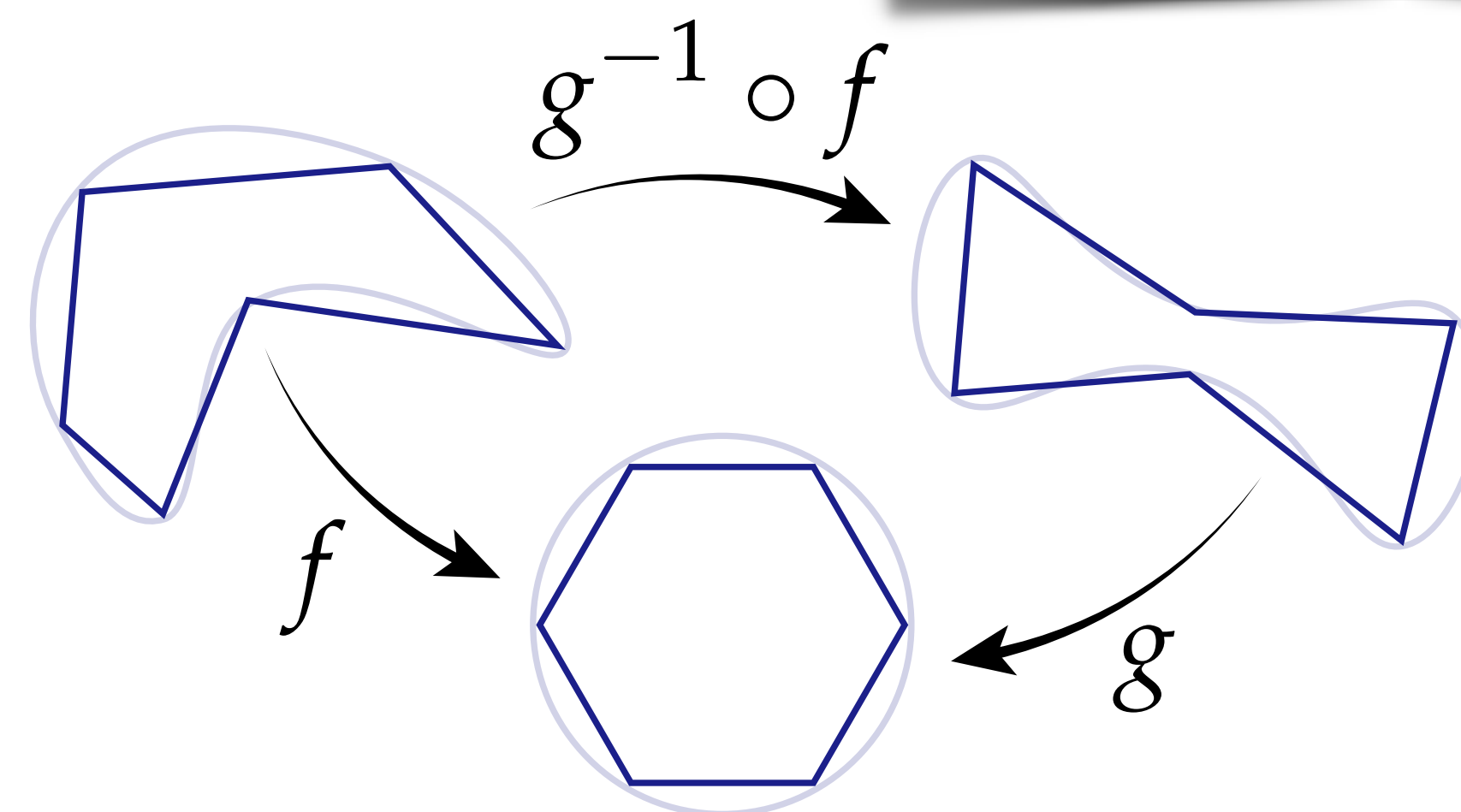

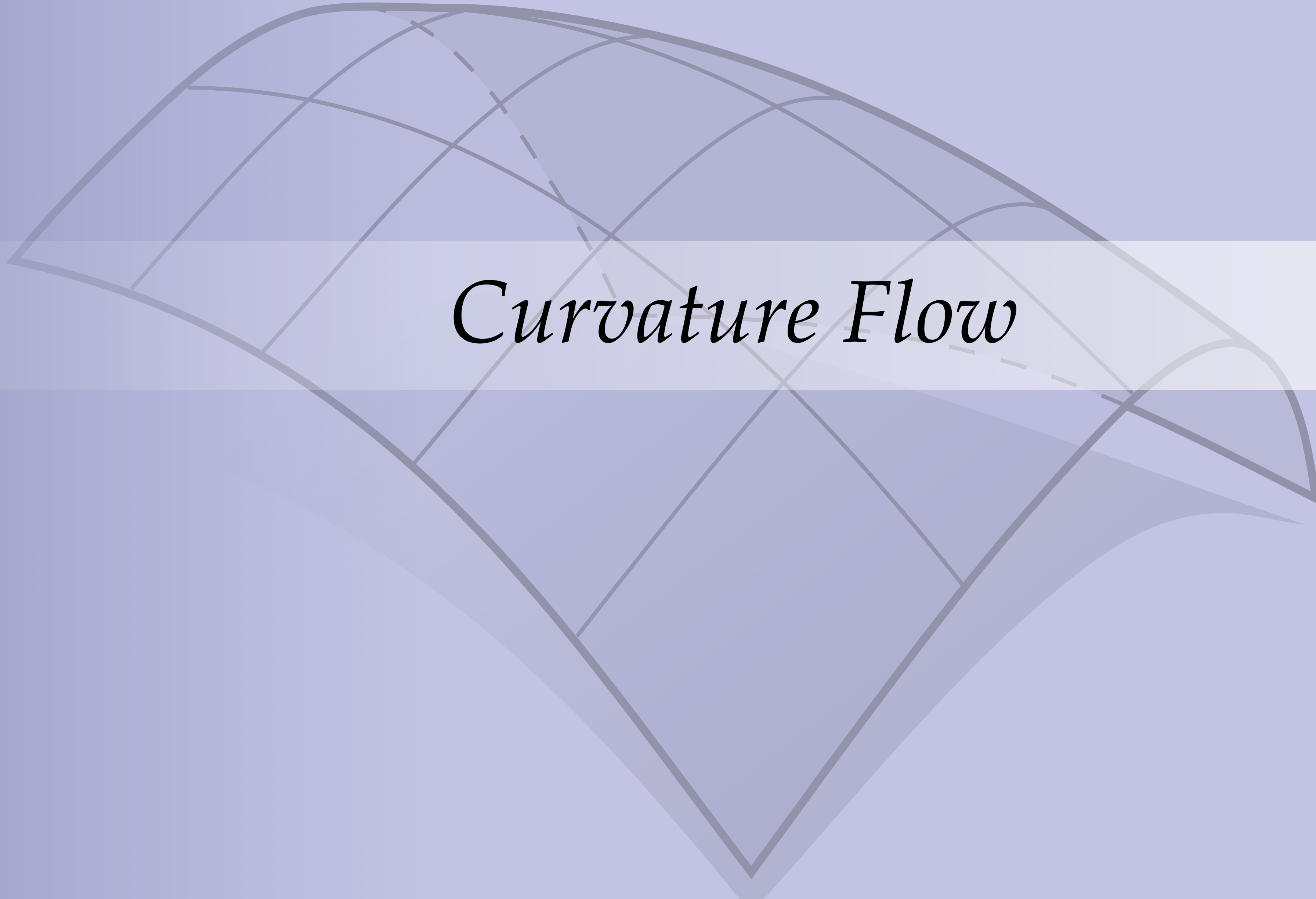

Curvature Flow

Curvature Flow on Curves

- A *curvature flow* is a time evolution of a curve (or surface) driven by some function of its curvature.
- Such flows model physical *elastic rods*, can be used to find shortest curves (*geodesics*) on surfaces, or might be used to smooth noisy data (e.g., image contours).
- Two common examples: *length-shortening flow* and *elastic flow*.

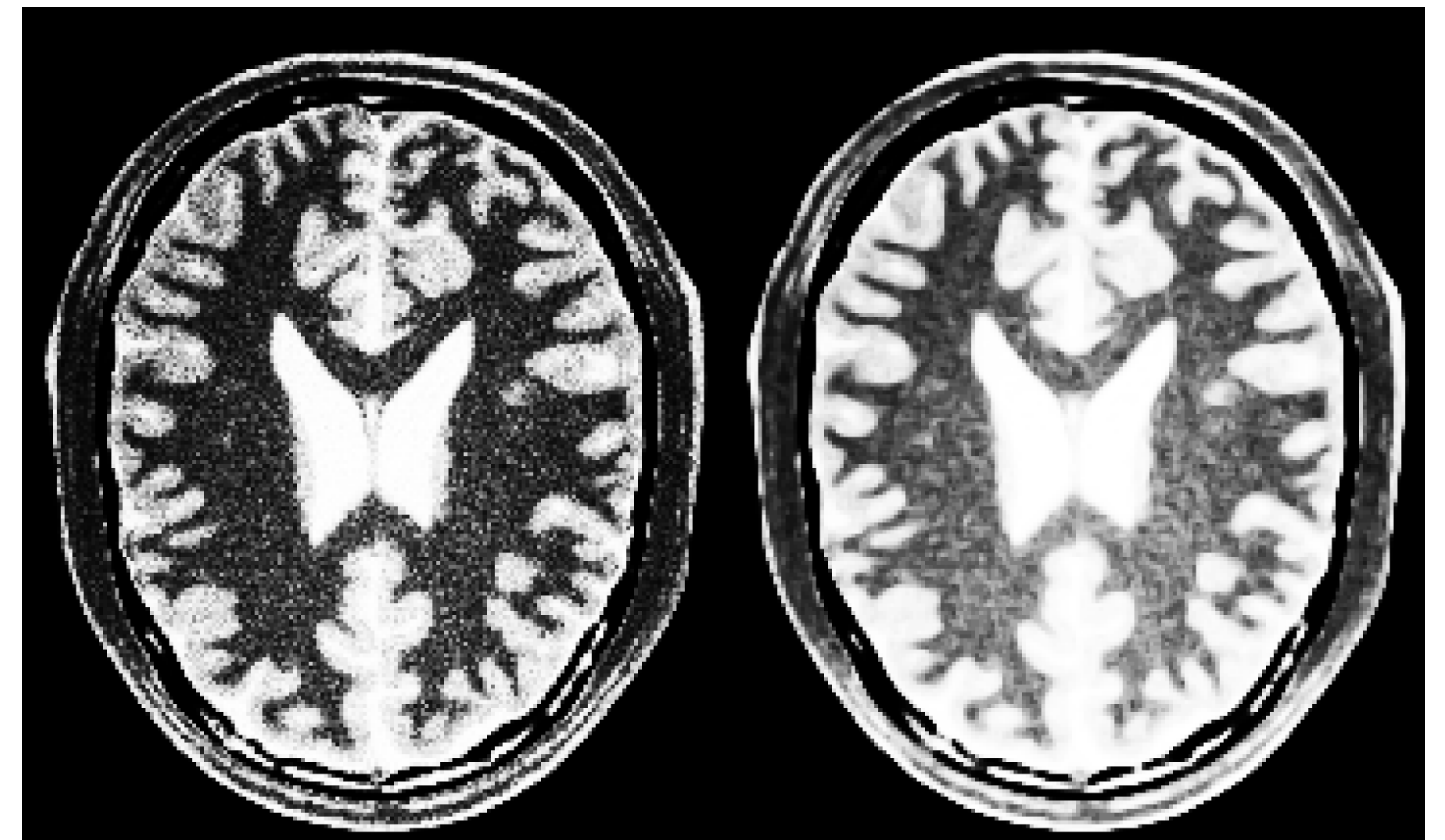
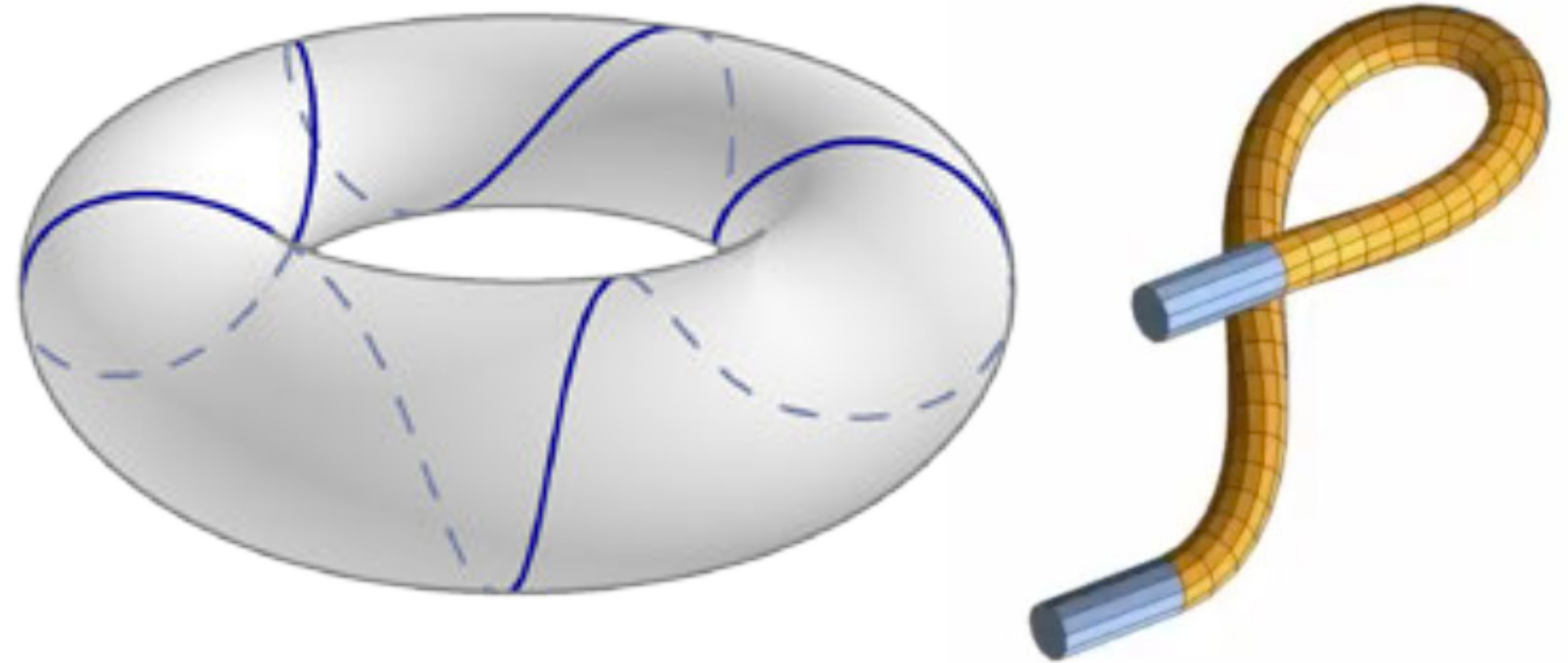

Discretizing a Gradient Flow

- Two possible paths for discretizing any gradient flow:

1. **First** derive the gradient of the objective in the smooth setting, **then** discretize the resulting evolution equation.

2. **First** discretize the objective itself, **then** take the gradient of the resulting discrete objective.

- In general, *will not lead to the same numerical scheme/algorithm!*

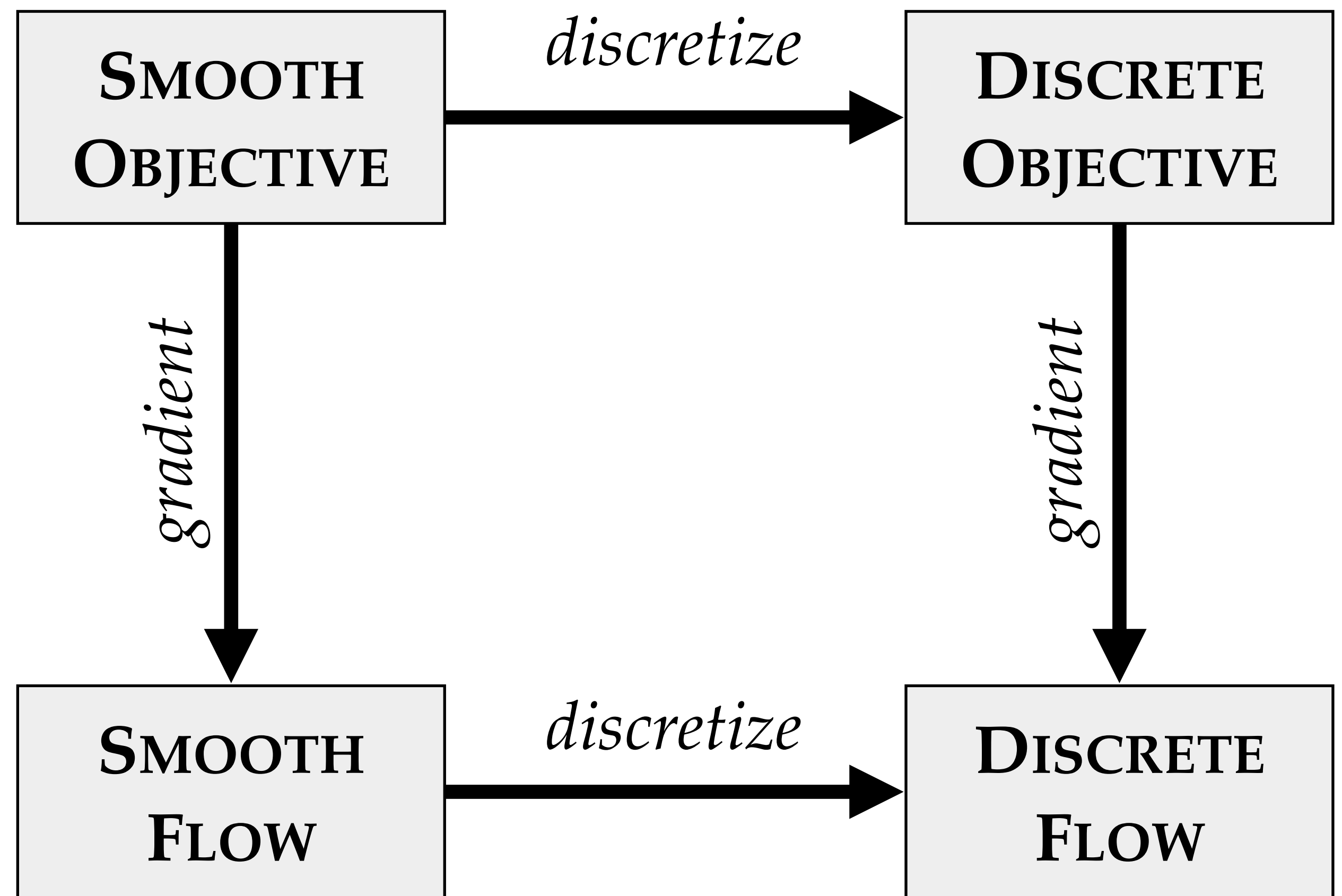

(Does **NOT** commute in general.)

Length Shortening Flow

- The objective for length shortening flow is simply the total length of the curve; the flow is then the (L^2) gradient flow.
- For closed curves, several interesting features (Gage-Grayson-Hamilton):
 - Center of mass is preserved
 - Curves flow to “round points”
 - Embedded curves remain embedded

$$\text{length}(\gamma) := \int_0^L \left| \frac{d}{ds} \gamma \right| ds$$

$$\frac{d}{dt} \gamma = -\nabla_{\gamma} \text{length}(\gamma)$$

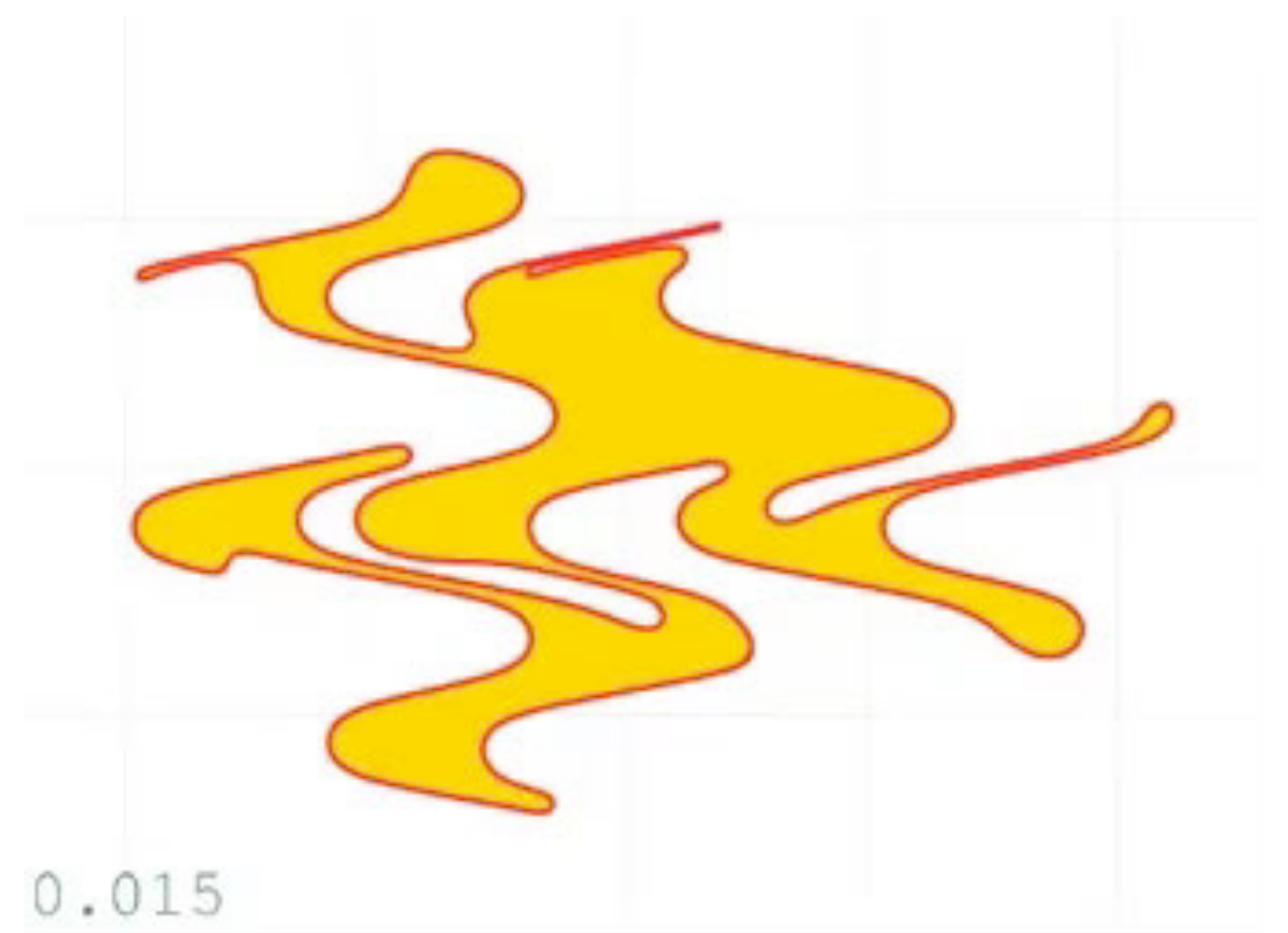

credit: Sigurd Angenent

Length Shortening Flow

Let $\text{length}(\gamma)$ denote the total length of a regular plane curve $\gamma : [0, L] \rightarrow \mathbb{R}^2$, and consider a variation $\eta : [0, L] \rightarrow \mathbb{R}^2$ vanishing at endpoints. One can then show that

$$\frac{d}{d\varepsilon} \Big|_{\varepsilon=0} \text{length}(\gamma + \varepsilon\eta) = - \int_0^L \langle \eta(s), \kappa(s)N(s) \rangle ds$$

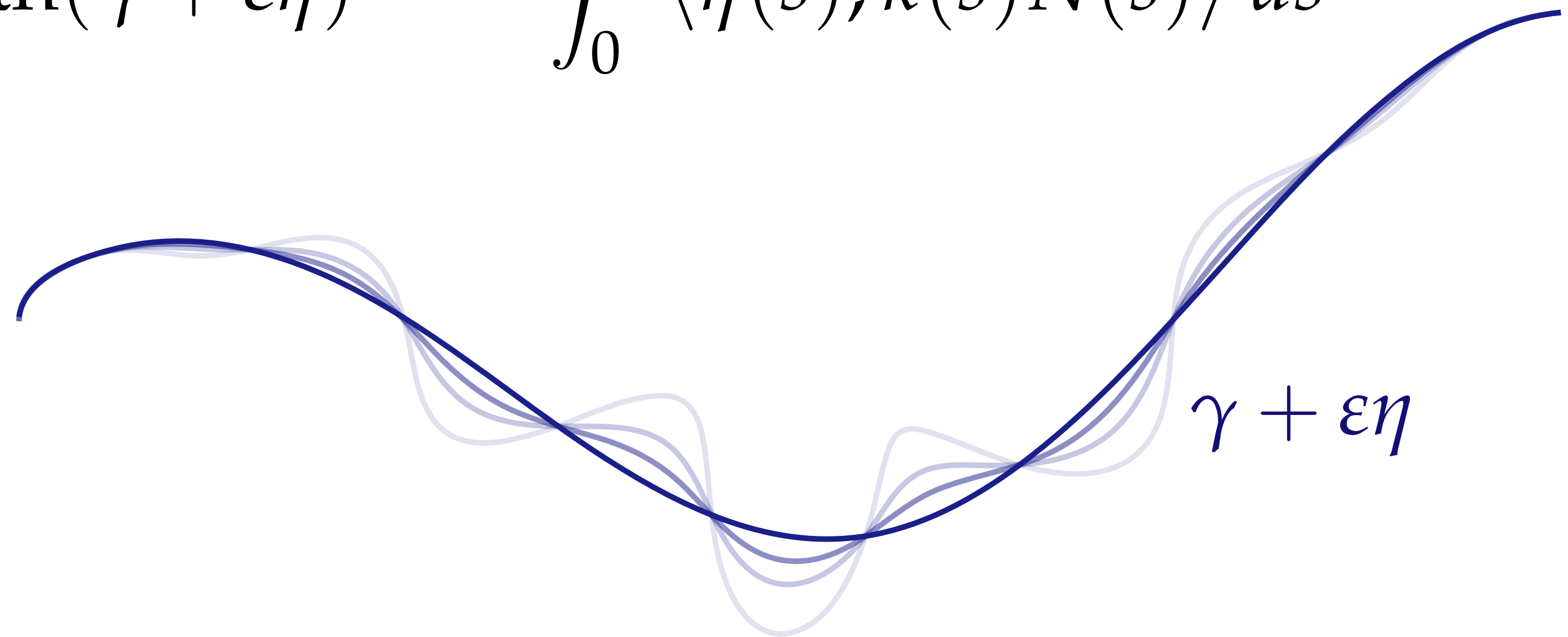

Key idea: quickest way to reduce length is to move in the direction κN .

Length Shortening Flow—Forward Euler

- At each moment in time, move curve in normal direction with speed proportional to curvature
- “Smooths out” curve (e.g., noise), eventually becoming circular
- Discretize by replacing time derivative with difference in time; smooth curvature with one (of many) curvatures
- Repeatedly add a little bit of κN (“forward Euler method”)

$$\frac{d}{dt} \gamma(s, t) = -\kappa(s, t) N(s, t)$$

$$\frac{\gamma_i^{t+1} - \gamma_i^t}{\tau} = -\kappa_i^t N_i^t$$

$$\Rightarrow \gamma_i^{t+1} = \gamma_i^t - \tau \kappa_i^t N_i^t$$

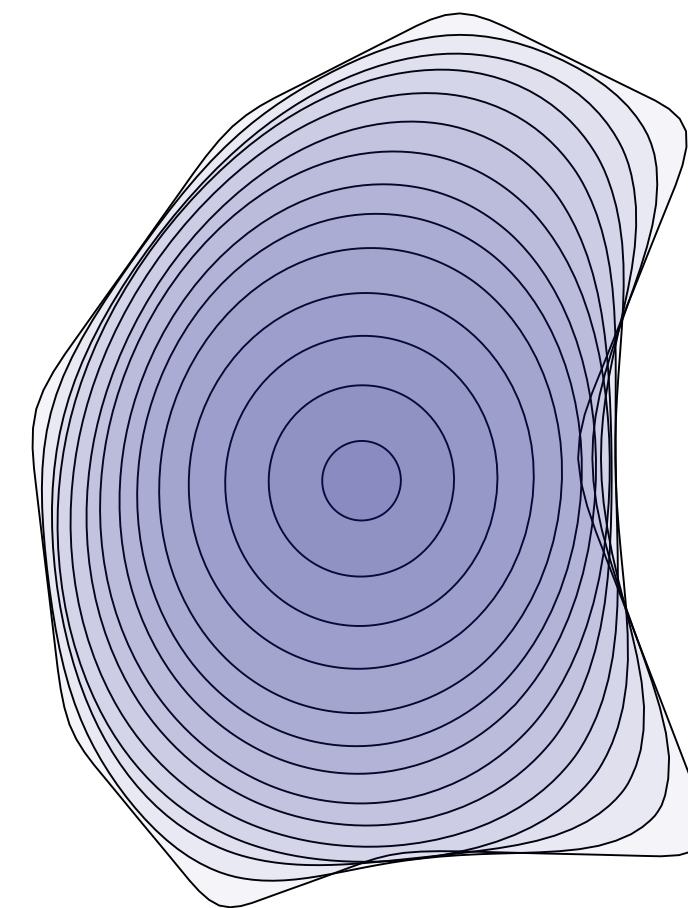

smooth

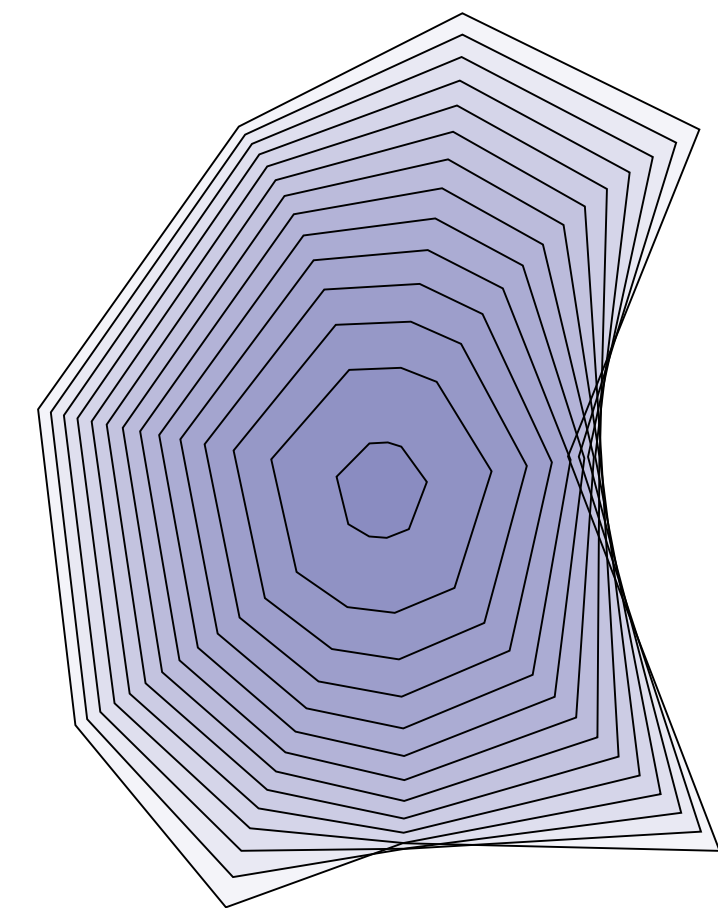

discrete

Elastic Flow

- Basic idea: rather than shrinking length, try to reduce *bending* (curvature)
- Objective is integral of squared curvature; elastic flow is then gradient flow on this objective
- Minimizers are called *elastic curves*
- More interesting w/ constraints (e.g., endpoint positions & a tangents)

$$E(\gamma) := \int_0^L \kappa(s)^2 ds$$
$$\frac{d}{dt} \gamma = -\nabla_{\gamma} E(\gamma)$$

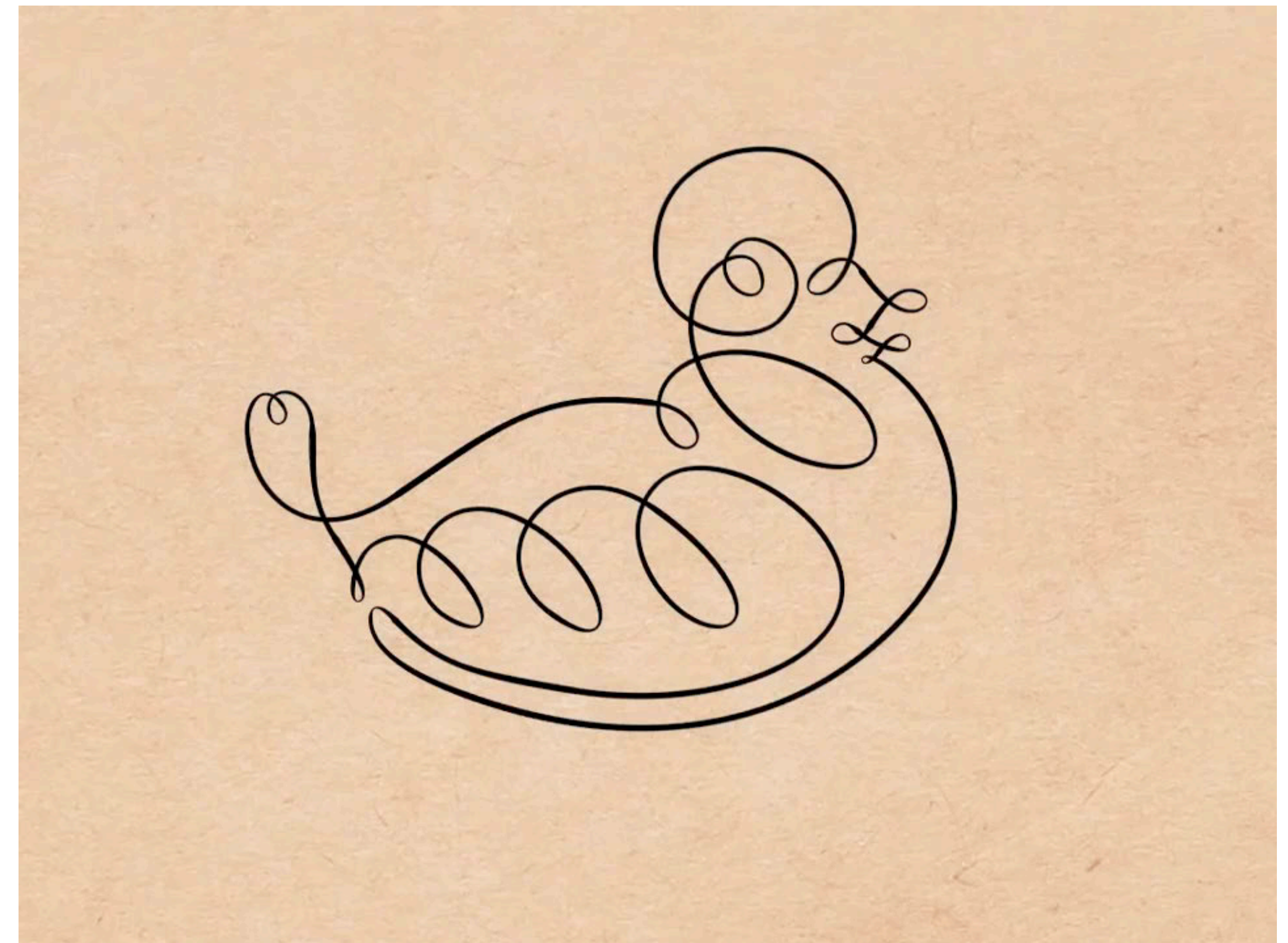

Isometric Elastic Flow

- Different way to smooth out a curve is to directly “shrink” curvature
- Discrete case: “scale down” turning angles, then use the fundamental theorem of discrete plane curves to reconstruct
- Extremely stable numerically; exactly preserves edge lengths
- Challenge: how do we make sure closed curves remain closed?



Elastic Rods

- For space curve, can also try to minimize both *curvature* **and** *torsion*
- Both in some sense measure “non-straightness” of curve
- Provides rich model of *elastic rods*
- Lots of interesting applications (simulating hair, laying cable, ...)



From Bergou et al, “Discrete Elastic Rods”

Untangling Knots

- Is a given curve “knotted?”
- Minimize elastic energy *and* penalize self-collision
- *Might* go to smoothest curve in same isotopy class

$$\int_0^L \int_0^L \frac{1}{|\gamma(s) - \gamma(t)|^2} - \frac{1}{d(s,t)^2} ds dt$$

Möbius energy

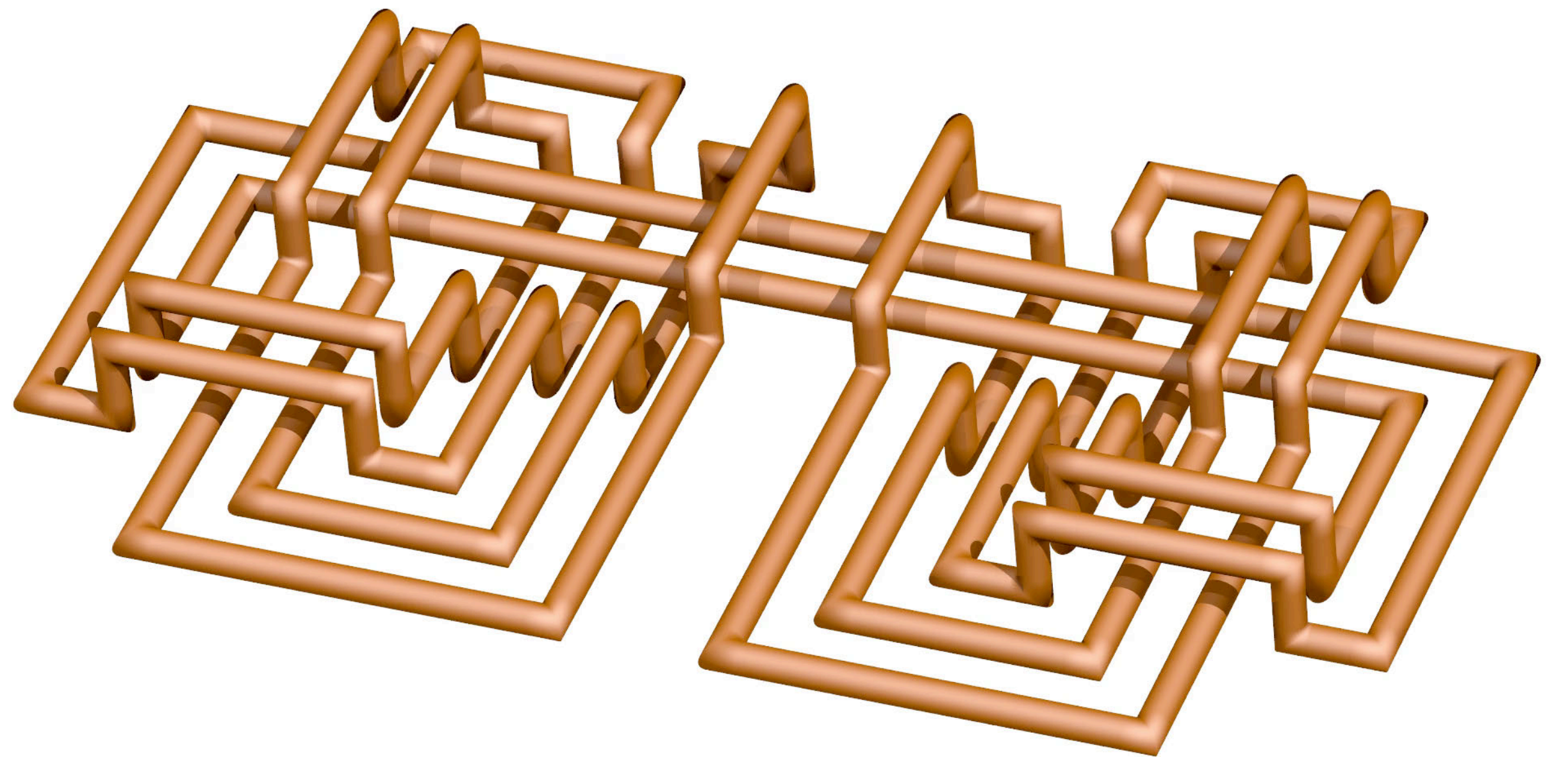
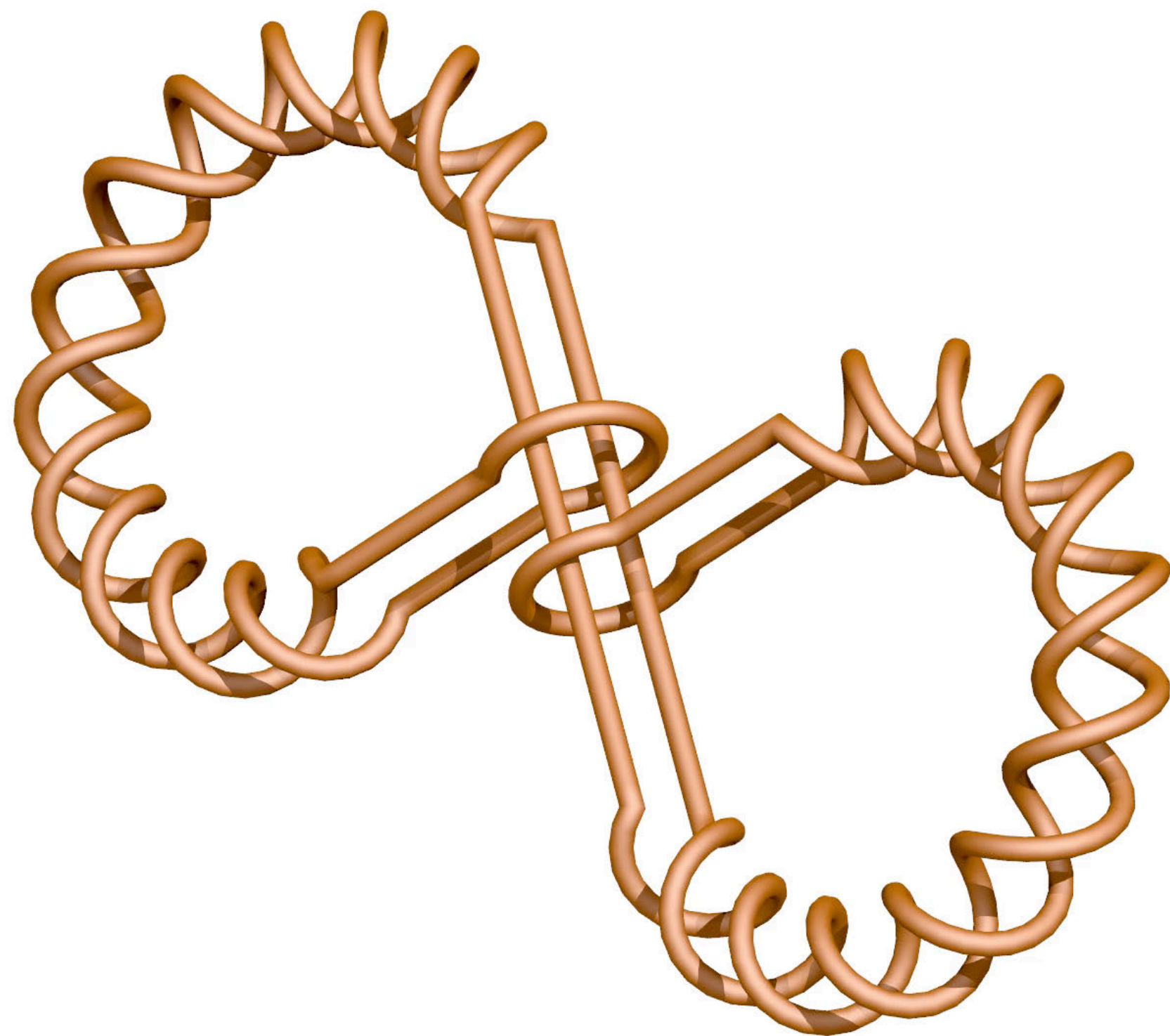

Credit: Henrik Schumacher

Thanks!

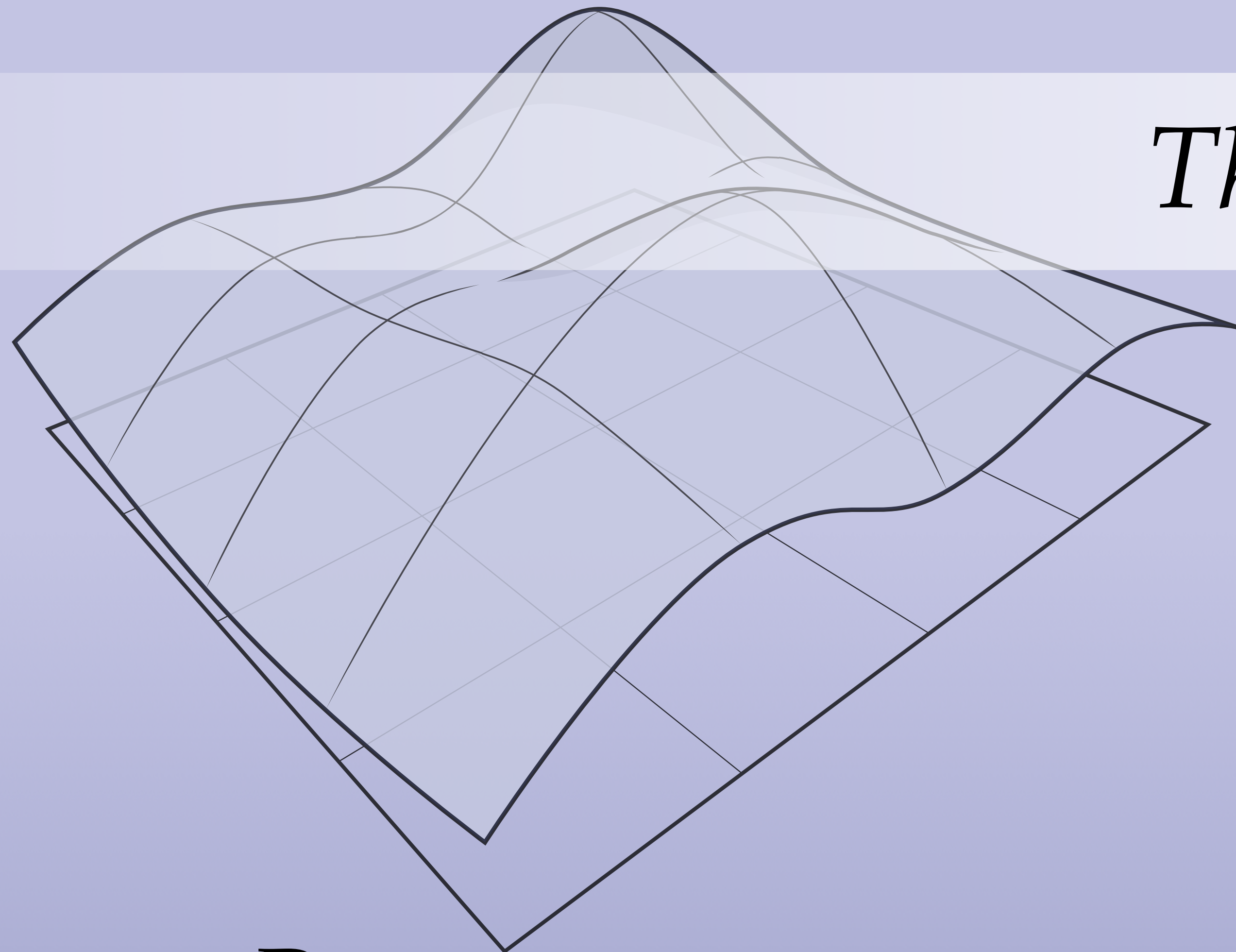

DISCRETE DIFFERENTIAL

GEOMETRY:

AN APPLIED INTRODUCTION

Keenan Crane • CMU 15-458/858