

Discrete Differential Geometry. Consistency as Integrability

Alexander I. Bobenko, Yuri B. Suris

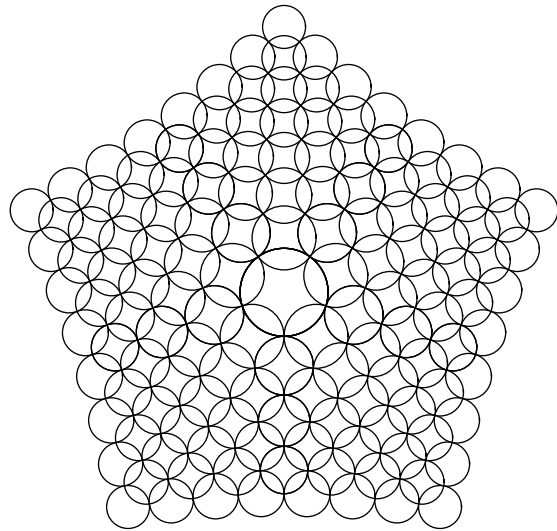

Supported by the DFG Forschergruppe “Polyhedral Surfaces” and the DFG Research Center MATHEON “Mathematics for key technologies” in Berlin.

Contents

0	Introduction	5
1	Classical differential geometry	13
1.1	Conjugate nets	14
1.2	Orthogonal nets	18
1.3	Moutard nets	23
1.4	Asymptotic nets	25
1.5	Surfaces with constant Gaussian curvature	27
1.6	Isothermic surfaces	29
	Appendix: Möbius-geometric formalism	33
2	Discrete differential geometry	39
2.1	Discrete conjugate nets	39
2.2	Discrete orthogonal nets	47
2.3	Discrete Moutard nets	55
2.4	Discrete asymptotic nets	58
2.5	Discrete K-nets	61
2.6	Discrete isothermic nets	64
2.7	Discrete surfaces made of spheres	69
3	Approximation	73
3.1	Discrete hyperbolic systems	73
3.2	Discrete approximation in hyperbolic systems	75
3.3	Conjugate nets	77
3.4	Orthogonal nets	78
3.5	Moutard nets	82
3.6	A-surfaces	83
3.7	K-surfaces	84

4	Consistency as integrability	87
4.1	From 3D consistency to BT and ZCR	87
4.2	Classification of 3D consistent systems	97
4.2.1	2D systems with fields on vertices and labelled edges	97
4.2.2	2D systems with fields on edges	100
4.3	Discrete Laplace type equations	104
4.4	Geometry of 3D consistent equations	108
5	Discrete linear complex analysis	113
5.1	Basics of discrete complex analysis	113
5.2	M-transformation for CR equations	116
5.3	Integrable discrete Cauchy-Riemann equations	119
5.4	Discrete exponential functions	123
5.5	Discrete logarithmic function	125
6	Integrable circle patterns	131
6.1	Circle patterns	131
6.2	Integrable cross-ratio and Hirota systems	134
6.3	Integrable circle patterns	137
6.4	z^a and $\log z$ circle patterns	140
6.5	Linearization	145
	Bibliography	149

Chapter 0

Introduction

A new field of *discrete differential geometry* is presently emerging on the border between differential and discrete geometry. Whereas classical differential geometry investigates smooth geometric shapes (such as surfaces), and discrete geometry studies geometric shapes with finite number of elements (such as polyhedra), the discrete differential geometry aims at the development of discrete equivalents of notions and methods of smooth surface theory. Current interest in this field derives not only from its importance in pure mathematics but also from its relevance for other fields like computer graphics. Recent progress in discrete differential geometry has lead, somewhat unexpectedly, to a better understanding of some fundamental structures lying in the basis of the classical differential geometry and of the theory of integrable systems (this is schematically presented on Fig. 1). The goal of this book is to give a systematic presentation of current achievements in this field.

The classical period of development of surface theory resulted in the beginning of the 20-th century in an enormous amount of knowledge on numerous special classes of surfaces, coordinate systems and their transformations, which is summarized in extensive volumes by Darboux [Da1, Da2], Bianchi [Bi] etc. One can say that the local differential geometry of special classes of surfaces and coordinate systems has been completed during this heroic period. Mathematicians of that era have found most (if not all) geometries of interest and knew nearly everything about their properties. It was observed that such special geometries as minimal surfaces, surfaces with constant curvature, isothermic surfaces, orthogonal and conjugate coordinate systems, Ribaucour sphere congruences, Weingarten line congruences etc. have many similar features. Among others we mention here Bäcklund

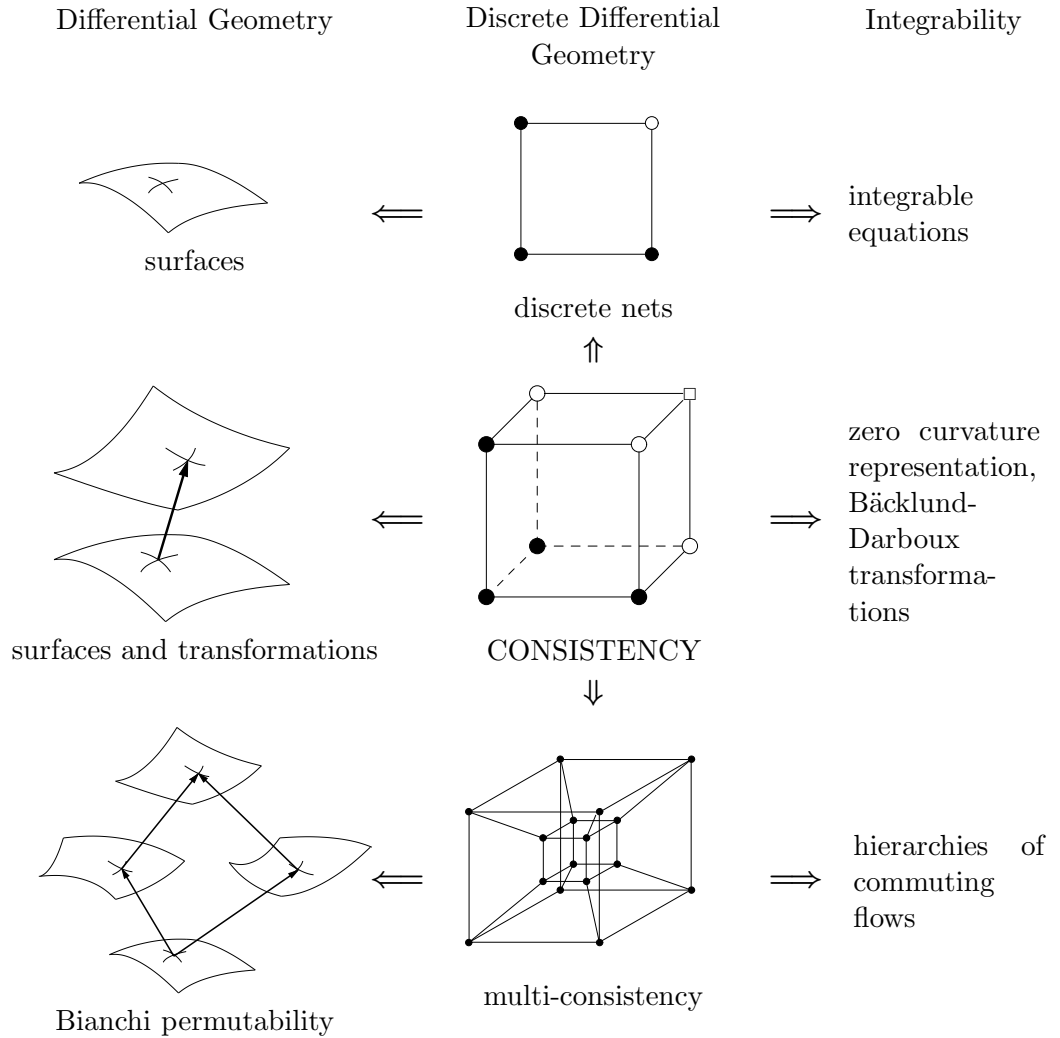

Figure 1: Fundamental consistency principle of the discrete differential geometry as a conceptual basis of the differential geometry of special surfaces and of the integrability.

and Darboux type transformations, with remarkable permutability properties investigated mainly by Bianchi, and existence of special deformations within the class (associated family). Geometers realized that there should exist a unifying fundamental structure behind all these common properties of quite different geometries. And they were definitely looking for this structure [J, E2].

Much later, after advent of the solitons theory in the the last quarter of the 20-th century, these common similar features were recognized to be associated to *integrability* of the underlying differential equations. However, the current status of the notion of integrability remains unsatisfactory from the point of view of a mathematician. There exists no commonly accepted definition of the integrability (as the title of the volume “What is integrability?” [Z] clearly demonstrates). Different scientists suggest different properties as defining ones. Usually, one just refers to some common features as Darboux transformations etc., exactly like the differential geometers of the classical period did.

A progress in understanding of the unifying fundamental structure the classical differential geometers were looking for, and simultaneously in understanding of the very nature of integrability, came from the efforts to *discretize* all these theories. It turns out that many sophisticated properties of differential-geometric objects find their simple explanation within the discrete differential geometry. The early period of its development is documented in the works of Sauer and Wunderlich [Sa, W]. The modern period began with the work by Bobenko and Pinkall [BobP1, BobP2] and by Doliwa and Santini [DoS1, CDS]. A closely related development of the spectral theory of difference operators on graphs was initiated by Novikov with collaborators [NoD, No1, No2], see also [DyN] for a further development of a discrete complex analysis on triangulated manifolds. Discrete differential geometry deals with multidimensional discrete nets (i.e., maps from the regular cubic lattice \mathbb{Z}^m into \mathbb{R}^N or some other suitable space) specified by certain geometric properties. In this setting, discrete surfaces appear as two-dimensional layers of multidimensional discrete nets, and their transformations correspond to shifts in the transversal lattice directions. A characteristic feature of the theory is that all lattice directions are on equal footing with respect to the defining geometric properties. Due to this symmetry, discrete surfaces and their transformations become indistinguishable. We associate such a situation with the *multidimensional consistency* (of geometric properties, resp. of equations which serve for their analytic description). The multidimensional consistency, and therefore the existence and construction of multidimensional discrete nets, relies just on certain

incidence theorems of elementary geometry.

Conceptually, one can think of passing to a continuum limit by refining mesh size in some of the lattice directions. In these directions the net converges to smooth surfaces whereas those directions that remain discrete correspond to transformations of the surfaces (see Fig. 2). Differential geometric properties of special classes of surfaces and their transformations follow in this way from (and find their simple explanation in) the elementary geometric properties of the original multidimensional discrete nets. In particular, difficult classical theorems about permutability of the Bäcklund-Darboux type transformations (Bianchi permutability) for various geometries follow directly from the symmetry of the underlying discrete nets, and are therefore built in the very core of the theory. Thus the pass from differential geometry to elementary geometry via discretization (or, in an opposite direction, the derivation of the differential geometry from the discrete differential geometry) leads to enormous conceptual simplifications, and the true roots of the classical theory of special classes of surfaces are found in various incidence theorems of elementary geometry. However, these elementary roots become deeply hidden in the classical differential geometry, since the continuum limit from the discrete master theory to the classical one is inevitably accompanied by a break of the symmetry among the lattice directions, which always yields essential structural complications.

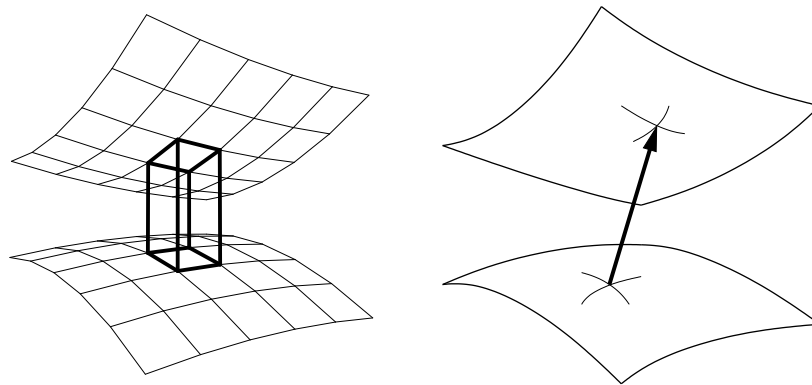

Figure 2: From the discrete master theory to the classical theory: surfaces and their transformations appear by refining two of three net directions.

To give a rigorous justification of this philosophy, one needs to prove convergence of the procedure just described. Theorems of this kind were lacking in the literature until recently. The first results of this kind have been proven

by the authors in a common work with Matthes [BobMaS1, BobMaS2]. This makes the general philosophy of the discrete differential geometry to a firmly established mathematical truth for several important classes of surfaces and coordinate systems, like conjugate nets, orthogonal nets, including general surfaces parametrized along curvature lines, surfaces with constant negative Gaussian curvature, and general surfaces parametrized along asymptotic lines. For some other classes, like isothermic surfaces, the convergence results still wait to be rigorously established.

But finding simple discrete explanations for complicated differential geometric theories is not the only outcome of this development. It is well known that differential equations which analytically describe interesting special classes of surfaces are integrable (in the sense of the theory of integrable systems), and, conversely, many of interesting integrable systems admit a differential-geometric interpretation. Having identified the roots of the integrable differential geometry in the multidimensional consistency of discrete nets, we are led to a new (geometric) understanding of the integrability itself. First, we adhere to the viewpoint that the central role in this theory belongs to *discrete integrable systems*. In particular, all the great variety of integrable differential equations can be derived from several fundamental discrete systems by performing different continuous limits. Further, and more important, we come to a constructive and almost algorithmic definition of integrability of discrete equations as their multidimensional consistency, introduced by the authors in [BobSu1] (and independently in [Nij]). It turns out that this definition captures enough structure to yield such traditional attributes of integrable equations as zero curvature representations and Bäcklund-Darboux transformations (which, in turn, serve as the basis for applying analytic methods like inverse scattering, finite gap integration, Riemann-Hilbert problems, etc.). A continuous counterpart (and consequence) of the multidimensional consistency is the well-known fact that integrable systems never appear alone but are organized into hierarchies of commuting flows.

The geometric way of thinking about the discrete integrability has also led to introducing novel concepts into the latter. One of the reasons to consider discrete integrable systems on the regular square lattice \mathbb{Z}^2 is the desire to have a proper model for *parametrized surfaces*. However, an immanent and important feature of various parametrizations of surfaces is the existence of distinguished points, where the combinatorics of coordinate lines change (like umbilic points, where the combinatorics of the curvature lines is special). This compels us to introduce *quad-graphs*, which are cell decompositions of topological two-manifolds with quadrilateral faces. Their

elementary building blocks are still quadrilaterals but are attached to one another in a manner which can be more complicated than in \mathbb{Z}^2 . This notion has been introduced into the context of discrete differential geometry in [BobP3], and a systematic development of the theory of integrable systems on quad-graphs has been undertaken by the authors in [BobSu1].

The structure of the book follows the logic of this introduction. We start in Chapter 1 with an overview of some classical results of the surface theory, focusing on transformations of surfaces. The geometries considered here include general conjugate and orthogonal nets in spaces of arbitrary dimension, asymptotic nets on general surfaces, as well as special classes of surfaces, like isothermic ones and surfaces with constant negative Gaussian curvature. There are no proofs in this chapter: on one hand, these tedious analytic proofs can be found in the original literature, and on the other hand, the discrete approach which we develop in the subsequent chapters will lead to conceptually transparent and technically much simpler proofs.

In Chapter 2 we define and investigate discrete analogs of the classical geometries discussed in the previous chapter, focusing on the idea of multi-dimensional consistency of discrete nets. It turns out that all these discrete analogs are reductions of discrete conjugate nets, which are multidimensional nets with the combinatorics of \mathbb{Z}^m , consisting of planar quadrilaterals. Imposing additional constraints on the geometry of elementary quadrilaterals, one comes to discrete orthogonal nets, discrete asymptotic nets, discrete isothermic surfaces, discrete surfaces with constant negative Gaussian curvature etc.

Then in Chapter 3 we develop an approximation theory for hyperbolic difference systems, which is applied to derive the classical theory of smooth surfaces as a continuum limit of the discrete theory. We prove that discrete nets of Chapter 2 approximate the corresponding smooth geometries of Chapter 1 simultaneously with their transformations. Bianchi's and Eisenhart's permutability theorems for transformations appear in this approach as simple corollaries.

In Chapter 4 we formulate the concept of multi-dimensional consistency as a defining principle of integrability. We derive basic features of integrable systems, such as the zero curvature representation, Bäcklund-Darboux transformations, from the consistency principle. At this point, the theory makes an interesting conceptual turn. First, we generalize the underlying combinatorial structure of the two-dimensional theory from the regular square lattice to arbitrary quad-graphs, i.e., cell decomposition of surfaces with all quadrilateral faces. Introducing these generalized combinatorics has been partly motivated by the desire to have proper discrete models for ge-

ometrically significant special points of parametrized surfaces, like umbilic points in the curvature line parametrization. But then the multidimensional consistency allows us to regard integrable systems on quad-graphs as systems on regular square lattices \mathbb{Z}^m restricted to quadrilateral surfaces. At this point, interesting interrelations with the discrete geometry and the combinatorial analysis come onto the scene.

Finally, in Chapters 5, 6 these ideas are applied to discrete complex analysis. We study Laplace operators on graphs, discrete harmonic and holomorphic functions. The linear discrete complex analysis appears here as a linearization of the theory of circle patterns. The consistency principle allows us to single out distinguished cases where we obtain more detailed analytic results (like Green's function and isomonodromic special functions).

Essential parts of this book are based on results obtained jointly with Vsevolod Adler, Tim Hoffmann, Daniel Matthes, Christian Mercat and Ulrich Pinkall. We warmly thank them for inspiring collaboration.

Chapter 1

Classical differential geometry

In this chapter we discuss some classical results of the differential geometry of nets (parametrized surfaces and coordinate systems) in \mathbb{R}^N , mainly concentrated around the topics of transformations of nets and of their permutability properties. This classical area was very popular in the differential geometry of the 19th and of the first quarter of the 20th century, and is well documented in the fundamental treatises [Bi, Da1, Da2, E1, E2, Tzi] and others. Our presentation mainly follows these classical treatments, of course with modifications which reflect our present points of view. We do not trace back the exact origin of the concrete classical results: often enough this turns out to be a complicated task in the history of mathematics which still waits for its competent investigation.

For the classes of nets described by essentially two-dimensional systems (special classes of surfaces such as surfaces with a constant negative Gaussian curvature or isothermic surfaces), the permutability theorems, mainly due to Bianchi, are dealing with a *quadruple* of surfaces (depicted as vertices of a so-called *Bianchi quadrilateral*). Given three surfaces of such a quadruple, the fourth one is uniquely defined, see Theorems 1.20 and 1.24.

For the classes of nets described by essentially three-dimensional systems (conjugate nets; orthogonal nets, including general surfaces parametrized by curvature lines; Moutard nets; general surfaces parametrized by asymptotic lines), the situation is somewhat different. The corresponding permutability theorems (Theorems 1.3, 1.6, 1.11, and 1.16) consist of two parts. The first parts present the traditional view and are dealing with Bianchi quadrilaterals. In our opinion, this is not the proper setting in the three-dimensional

context, and the non-uniqueness of the fourth net in these theorems reflects this. The natural setting for permutability is given in the second parts, where the permutability is associated with an *octuple* of nets, depicted as vertices of a combinatorial cube, so that the eighth net is uniquely determined by other seven ones. We found the first instance of this kind of statement in [E2], §24 (“extended theorem of permutability” for conjugate nets), and propose therefore to term such an octuple of nets as an *Eisenhart cube*; in the modern literature on integrable systems, this kind of permutability theorems in classical differential geometry was (re-)discovered in [GT] (for orthogonal nets). Our discrete philosophy makes the origin of such permutability theorems quite transparent.

A few remarks on notations: we denote independent variables of a net $f : \mathbb{R}^m \rightarrow \mathbb{R}^N$ by $u = (u_1, \dots, u_m) \in \mathbb{R}^m$, and we set $\partial_i = \partial/\partial u_i$. We write $\mathcal{B}_{i_1 \dots i_s} = \{u \in \mathbb{R}^m : u_i = 0, \quad i \neq i_1, \dots, i_s\}$ for s -dimensional coordinate planes (coordinate axes, if $s = 1$). We always suppose that the dimension of the ambient space $N \geq 3$.

1.1 Conjugate nets and their transformations

Conjugate nets. This classical notion can be defined as follows.

Definition 1.1 *A map $f : \mathbb{R}^m \rightarrow \mathbb{R}^N$ is called an m -dimensional conjugate net in \mathbb{R}^N , if $\partial_i \partial_j f \in \text{span}(\partial_i f, \partial_j f)$ at any $u \in \mathbb{R}^m$ and for all pairs $1 \leq i \neq j \leq m$.*

A parametrized surface in the three-space ($m = 2$, $N = 3$) is a conjugate net, if its second fundamental form is diagonal in this parametrization. Such a parametrization exists for a general surface in the three-space. It is important to note that Definition 1.1, as well as Definition 1.2 below, are dealing with projectively invariant notions only, and thus belong to the projective differential geometry. In this setting the space \mathbb{R}^N where conjugate net lives should be interpreted as an affine part of $\mathbb{P}(\mathbb{R}^{N+1})$.

From Definition 1.1 there follows that conjugate nets are described by the following (linear) differential equations:

$$\partial_i \partial_j f = c_{ji} \partial_i f + c_{ij} \partial_j f, \quad i \neq j, \quad (1.1)$$

with some functions $c_{ij} : \mathbb{R}^m \rightarrow \mathbb{R}$. Compatibility of these equations is expressed by the following system of (nonlinear) differential equations:

$$\partial_i c_{jk} = c_{ij} c_{jk} + c_{ji} c_{ik} - c_{jk} c_{ik}, \quad i \neq j \neq k \neq i, \quad (1.2)$$

which thus split off from eqs. (1.1) for f . System (1.1), (1.2) is hyperbolic (see Sect. 4); the following data define a well-posed Goursat problem for this system and determine a conjugate net f uniquely:

(Q₁) values of f on the coordinate axes \mathcal{B}_i for $1 \leq i \leq m$, i.e., m smooth curves $f|_{\mathcal{B}_i}$ with a common intersection point $f(0)$;

(Q₂) values of c_{ij} , c_{ji} on the coordinate planes \mathcal{B}_{ij} for all $1 \leq i < j \leq m$, i.e., $m(m-1)$ smooth real-valued functions $c_{ij}|_{\mathcal{B}_{ij}}$ of two variables.

Alternative analytic description of conjugate nets. Given the functions c_{ij} , define functions $h_i : \mathbb{R}^m \rightarrow \mathbb{R}$ as solutions of the system of differential equations

$$\partial_i h_j = c_{ij} h_j, \quad i \neq j. \quad (1.3)$$

Compatibility of this system is a consequence of (1.2). Define vectors $v_i = h_i^{-1} \partial_i f$. It follows from (1.1) and (1.3) that these vectors satisfy the following differential equations:

$$\partial_i v_j = \frac{h_i}{h_j} c_{ji} v_i, \quad i \neq j. \quad (1.4)$$

Thus, defining the *rotation coefficients* as

$$\beta_{ji} = \frac{h_i}{h_j} c_{ji}, \quad (1.5)$$

we end up with the following system:

$$\partial_i f = h_i v_i, \quad (1.6)$$

$$\partial_i v_j = \beta_{ji} v_i, \quad i \neq j, \quad (1.7)$$

$$\partial_i h_j = h_i \beta_{ij}, \quad i \neq j. \quad (1.8)$$

Rotation coefficients satisfy a closed system of differential equations, which follow from eqs. (1.2) upon substitution (1.5):

$$\partial_i \beta_{kj} = \beta_{ki} \beta_{ij}, \quad i \neq j \neq k \neq i. \quad (1.9)$$

Eqs. (1.9), known as the *Darboux system*, can be regarded as compatibility conditions of the linear differential equations (1.7).

Observe an important difference between two descriptions of conjugate nets: while the functions c_{ij} describe the *local geometry* of a net, this is not the case for the rotation coefficients β_{ij} . Indeed, to define the latter, one needs to find h_i as solutions of differential equations (1.3).

Transformations of conjugate nets. The most general class of transformations of conjugate nets was introduced by Jonas and Eisenhart.

Definition 1.2 A pair of m -dimensional conjugate nets $f, f^+ : \mathbb{R}^m \rightarrow \mathbb{R}^N$ is called a Jonas pair, if three vectors $\partial_i f$, $\partial_i f^+$ and $\delta f = f^+ - f$ are coplanar at any point $u \in \mathbb{R}^m$ of the definition domain and for any $1 \leq i \leq m$. The net f^+ is called a Jonas transform of the net f .

This definition yields that Jonas transformations are described by the following (linear) differential equations:

$$\partial_i f^+ = a_i \partial_i f + b_i (f^+ - f). \quad (1.10)$$

Of course, functions $a_i, b_i : \mathbb{R}^m \rightarrow \mathbb{R}$ have to satisfy (nonlinear) differential equations, which express the compatibility of eqs. (1.10) with (1.1):

$$\partial_i a_j = (a_i - a_j) c_{ij} + b_i (a_j - 1), \quad (1.11)$$

$$\partial_i b_j = c_{ij}^+ b_j + c_{ji}^+ b_i - b_j b_i, \quad (1.12)$$

$$a_j c_{ij}^+ = a_i c_{ij} + b_i (a_j - 1). \quad (1.13)$$

Following data determine a Jonas transform f^+ of a given conjugate net f uniquely:

(J₁) a point $f^+(0)$;

(J₂) values of a_i, b_i on the coordinate axes \mathcal{B}_i for $1 \leq i \leq m$, i.e., $2m$ smooth real-valued functions $a_i|_{\mathcal{B}_i}, b_i|_{\mathcal{B}_i}$ of one variable.

Observe a remarkable conceptual similarity between Definitions 1.1 and 1.2. Indeed, one can interpret the condition of Definition 1.1 as planarity of infinitesimal quadrilaterals $(f(u), f(u + \epsilon_i e_i), f(u + \epsilon_i e_i + \epsilon_j e_j), f(u + \epsilon_j e_j))$, while the condition of Definition 1.2 can be interpreted as planarity of infinitesimally narrow quadrilaterals $(f(u), f(u + \epsilon_i e_i), f^+(u + \epsilon_i e_i), f^+(u))$.

Classical formulation of the Jonas transformation. Our formulation of Jonas transformations is rather different from the classical one, which can be found, e.g., in [E2]. The latter is based on the formula

$$f^+ = f - \frac{\phi}{\psi} g, \quad (1.14)$$

whose data are: an additional solution $\phi : \mathbb{R}^m \rightarrow \mathbb{R}$ of eq. (1.1), a parallel to f net $g : \mathbb{R}^m \rightarrow \mathbb{R}^N$, and the function $\psi : \mathbb{R}^m \rightarrow \mathbb{R}$, associated to ϕ in the same way as g is related to f . We now demonstrate how to identify these ingredients within our approach and how they are specified by the initial data (J_{1,2}).

There follows from eqs. (1.11)–(1.13):

$$\partial_i \left(\frac{b_j}{a_j} \right) = c_{ij} \frac{b_j}{a_j} + c_{ji} \frac{b_i}{a_i} - \frac{b_j b_i}{a_j a_i}. \quad (1.15)$$

The symmetry of the right-hand sides of eqs. (1.15), (1.12) yields the existence of the functions $\phi, \phi^+ : \mathbb{R}^m \rightarrow \mathbb{R}$ such that

$$\frac{\partial_i \phi}{\phi} = \frac{b_i}{a_i}, \quad \frac{\partial_i \phi^+}{\phi^+} = b_i, \quad 1 \leq i \leq m. \quad (1.16)$$

These equations define ϕ, ϕ^+ uniquely up to respective constant factors, which can be fixed by requiring $\phi(0) = \phi^+(0) = 1$. An easy computation based on eqs. (1.15), (1.12) shows that the functions ϕ, ϕ^+ satisfy the following equations:

$$\partial_i \partial_j \phi = c_{ij} \partial_j \phi + c_{ji} \partial_i \phi, \quad (1.17)$$

$$\partial_i \partial_j \phi^+ = c_{ij}^+ \partial_j \phi^+ + c_{ji}^+ \partial_i \phi^+, \quad (1.18)$$

for all $1 \leq i \neq j \leq m$. Thus, a Jonas transformation yields some additional scalar solutions ϕ and ϕ^+ of the equations describing the nets f and f^+ , respectively. It is clear that the solution ϕ is directly specified by the initial data (J_2) . Indeed, these data yield the values ϕ along the coordinate axes, through integrating the first equations in (1.16); these values determine the solution of eq. (1.17) uniquely.

Further, introduce the quantities

$$g = \frac{f^+ - f}{\phi^+}, \quad \psi = -\frac{\phi}{\phi^+}. \quad (1.19)$$

Then a direct computation based on eqs. (1.10), (1.11)–(1.13), and (1.16) shows that the following equations hold:

$$\partial_i g = \alpha_i \partial_i f, \quad (1.20)$$

$$\partial_i \psi = \alpha_i \partial_i \phi, \quad (1.21)$$

where

$$\alpha_i = \frac{a_i - 1}{\phi^+}. \quad (1.22)$$

Thus, g is a parallel net to f , and ψ is an associated to ϕ function, in Eisenhart's terminology. Another computation leads to the relation

$$\partial_i \alpha_j = c_{ij} (\alpha_i - \alpha_j). \quad (1.23)$$

The same argument as above shows that the data (J_2) yield the values of ϕ^+ , and thus the values of α_i , on the coordinate axes \mathcal{B}_i . This uniquely specifies the solutions α_i of the compatible linear system (1.23). This, in turn, allows for a unique determination of the solutions g, ψ of eqs. (1.20), (1.21) with the initial data $g(0) = f^+(0) - f(0)$ and $\psi(0) = 1$ (here the data (J_1) enter into the construction). Thus, the classical formula (1.14) is recovered.

One can iterate Jonas transformations and obtain a sequence $f, f^+, (f^+)^+, \dots$, of conjugate nets. We will see that this can be interpreted as generating a conjugate net of dimension $M = m + 1$, with m continuous directions and one discrete direction. The most remarkable property of Jonas transformations is the following permutability theorem.

Theorem 1.3 (Permutability of Jonas transformations)

1) Let f be an m -dimensional conjugate net, and let $f^{(1)}$ and $f^{(2)}$ be its two Jonas transforms. Then there exists a two-parameter family of conjugate nets $f^{(12)}$ that are Jonas transforms of both $f^{(1)}$ and $f^{(2)}$. Corresponding points of the four conjugate nets $f, f^{(1)}, f^{(2)}$ and $f^{(12)}$ are co-planar.

2) Let f be an m -dimensional conjugate net. Let $f^{(1)}, f^{(2)}$ and $f^{(3)}$ be its three Jonas transforms, and let three further conjugate nets $f^{(12)}, f^{(23)}$ and $f^{(13)}$ be given such that $f^{(ij)}$ is a simultaneous Jonas transform of $f^{(i)}$ and $f^{(j)}$. Then there exists generically a unique conjugate net $f^{(123)}$ that is a Jonas transform of $f^{(12)}, f^{(23)}$ and $f^{(13)}$. The net $f^{(123)}$ is uniquely defined by the condition that any its point is co-planar with the corresponding points of $f^{(i)}, f^{(ij)}$ and $f^{(ik)}$ for any permutation (ijk) of (123) .

The situations described in this theorem can be interpreted as conjugate nets of dimension $M = m + 2$, resp. $M = m + 3$, with m continuous and two (resp. three) discrete directions.

The theory of discrete conjugate nets allows one to put all directions on an equal footing and to unify the theories of smooth nets and of their transformations. Moreover, we will see that both these theories may be seen as a *continuum limit* (in some precise sense) of the fully discrete theory, if the mesh sizes of all or some of the directions becomes infinitely small (see Fig. 2). This way of thinking is the guiding idea and the philosophy of the *discrete differential geometry*.

1.2 Orthogonal nets and their transformations

Orthogonal nets. An important subclass of conjugate nets is fixed in the

following definition.

Definition 1.4 *A conjugate net $f : \mathbb{R}^m \rightarrow \mathbb{R}^N$ is called an m -dimensional O-net (orthogonal net) in \mathbb{R}^N , if there holds $\partial_i f \perp \partial_j f$ at any $u \in \mathbb{R}^m$ and for all $1 \leq i \neq j \leq m$. Such a net is called an orthogonal coordinate system if $m = N$.*

Two-dimensional ($m = 2$) orthogonal nets are called *O-surfaces*. An O-surface in \mathbb{R}^3 is nothing but a surface parametrized along its curvature lines, or, otherwise said, parametrized so that both the first and the second fundamental forms are diagonal. Such a parametrization exists for a general surface in \mathbb{R}^3 in the neighborhood of a non-umbilic point. Note that Definition 1.4 is dealing only with notions which are invariant under Möbius transformations. Thus orthogonal nets (as well as their Ribaucour transformations from Definition 1.5 below) belong to the Möbius differential geometry. It will be important to preserve this symmetry group under discretization.

For an analytic description of an orthogonal net $f : \mathbb{R}^m \rightarrow \mathbb{R}^N$, introduce metric coefficients $h_i = |\partial_i f|$ and (pairwise orthogonal) unit vectors $v_i = h_i^{-1} \partial_i f$. Then there hold eqs. (1.6)–(1.9), supplemented by the *orthogonality constraint*

$$\partial_i \beta_{ij} + \partial_j \beta_{ji} = -\langle \partial_i v_i, \partial_j v_j \rangle, \quad i \neq j. \quad (1.24)$$

Indeed, eq. (1.7) holds since f is a conjugate net and v_j are orthonormal, and serves as a definition of *rotation coefficients* β_{ji} . Eq. (1.8) is a direct consequence of (1.6), (1.7). To derive eq. (1.24), one considers the identity $\partial_i \partial_j \langle v_i, v_j \rangle = 0$. So, a distinctive feature of orthogonal nets among general conjugate ones is that the rotation coefficients β_{ji} reflect the *local geometry*. In the same spirit, a solution to the system (1.3) is given by the locally defined metric coefficients h_i .

Eq. (1.24) is an *admissible constraint* for the system (1.6)–(1.9). This has the following meaning: eq. (1.24) involves two independent variables i, j only, and it is therefore sensible to ask for it to be fulfilled on the coordinate plane \mathcal{B}_{ij} . One can easily check that if a solution to the system (1.6)–(1.9) fulfills eq. (1.24) on all coordinate planes \mathcal{B}_{ij} for $1 \leq i < j \leq m$, then it is fulfilled everywhere on \mathbb{R}^m .

System (1.6)–(1.9), (1.24) is not hyperbolic, therefore it is less clear what data form a well-posed problem for it. It can be shown (see Sect. 3.4) that the following data can be used to determine an orthogonal net f uniquely:

- (O₁) values of f on the coordinate axes \mathcal{B}_i for $1 \leq i \leq m$, i.e., m smooth curves $f|_{\mathcal{B}_i}$, intersecting pairwise orthogonally at $f(0)$;

(O₂) $m(m-1)/2$ smooth functions $\gamma_{ij} : \mathcal{B}_{ij} \rightarrow \mathbb{R}$ for all $1 \leq i < j \leq m$, which have the meaning of $\gamma_{ij} = \frac{1}{2}(\partial_i \beta_{ij} - \partial_j \beta_{ji})|_{\mathcal{B}_{ij}}$.

Ribaucour transformations of orthogonal nets.

Definition 1.5 A pair of m -dimensional orthogonal nets $f, f^+ : \mathbb{R}^m \rightarrow \mathbb{R}^N$ is called a Ribaucour pair, if the corresponding coordinate curves of f and f^+ envelope one-parameter families of circles, i.e. if at any $u \in \mathbb{R}^m$ and for any $1 \leq i \leq m$ the straight lines spanned by the vectors $\partial_i f, \partial_i f^+$ at the corresponding points f, f^+ are interchanged by the reflection in the affine hyperplane orthogonal to $\delta f = f^+ - f$, which interchanges f and f^+ . The net f^+ is called a Ribaucour transform of f .

To describe a Ribaucour transformation analytically, we write:

$$\partial_i f^+ = r_i \left(\partial_i f - 2 \frac{\langle \partial_i f, \delta f \rangle}{\langle \delta f, \delta f \rangle} \delta f \right), \quad (1.25)$$

with some functions $r_i : \mathbb{R}^m \rightarrow \mathbb{R}$ which obviously coincide (up to a sign) with the quotients of the corresponding metric coefficients, $r_i^2 = (h_i^+ / h_i)^2$. Further, denote $\ell = |\delta f|$ and introduce the unit vector $y = \ell^{-1} \delta f$, so that $f^+ = f + \ell y$. Then, in the case $r_i > 0$, we find:

$$v_i^+ = v_i - 2\langle v_i, y \rangle y, \quad \partial_i y = \frac{1}{2} \theta_i (v_i^+ + v_i), \quad (1.26)$$

with the functions $\theta_i : \mathbb{R}^m \rightarrow \mathbb{R}$ defined as $\theta_i = (r_i - 1)h_i / \ell$. Eqs. (1.26) imply equations for the metric coefficients:

$$h_i^+ = h_i + \theta_i \ell, \quad \partial_i \ell = -\langle v_i, y \rangle (h_i^+ + h_i). \quad (1.27)$$

(In the case $r_i < 0$ one has to change the sign of the quantities v_i^+, h_i^+ in eqs. (1.26), (1.27).) Compatibility of the system (1.26) yields that θ_i have to satisfy certain differential equations:

$$\beta_{ij}^+ = \beta_{ij} - 2\langle v_i, y \rangle \theta_j, \quad \partial_i \theta_j = \frac{1}{2} \theta_i (\beta_{ij}^+ + \beta_{ij}). \quad (1.28)$$

Following data determine a Ribaucour transform f^+ of a given orthogonal net f uniquely:

(R₁) a point $f^+(0)$;

(R₂) values of θ_i on the coordinate axes \mathcal{B}_i for $1 \leq i \leq m$, i.e., m smooth functions $\theta_i|_{\mathcal{B}_i}$ of one variable.

According to the general philosophy, iterating Ribaucour transformations can be interpreted as adding an additional (discrete) dimension to an orthogonal net. The situation arising by adding two or three discrete dimensions is described in the following fundamental theorem.

Theorem 1.6 (Permutability of Ribaucour transformations)

1) Let f be an m -dimensional orthogonal net, and let $f^{(1)}$ and $f^{(2)}$ be its two Ribaucour transforms. Then there exists a one-parameter family of orthogonal nets $f^{(12)}$ that are Ribaucour transforms of both $f^{(1)}$ and $f^{(2)}$. Corresponding points of the four orthogonal nets f , $f^{(1)}$, $f^{(2)}$ and $f^{(12)}$ are concircular.

2) Let f be an m -dimensional orthogonal net. Let $f^{(1)}$, $f^{(2)}$ and $f^{(3)}$ be its three Ribaucour transforms, and let three further orthogonal nets $f^{(12)}$, $f^{(23)}$ and $f^{(13)}$ be given such that $f^{(ij)}$ is a simultaneous Ribaucour transform of $f^{(i)}$ and $f^{(j)}$. Then there exists generically a unique orthogonal net $f^{(123)}$ that is a Ribaucour transform of $f^{(12)}$, $f^{(23)}$ and $f^{(13)}$. The net $f^{(123)}$ is uniquely defined by the condition that the corresponding points of $f^{(i)}$, $f^{(ij)}$, $f^{(ik)}$ and $f^{(123)}$ are concircular for any permutation (ijk) of (123) .

The theory of discrete orthogonal nets will unify the theories of smooth orthogonal nets and of their transformations.

Möbius-geometric description of orthogonal nets. Since orthogonal nets belong to the Möbius differential geometry, it is useful to describe them with the help of the corresponding apparatus (a sketch of which is given in Appendix to Chapter 1). This has major conceptual and technical advantages. First, this description linearizes the invariance group of orthogonal nets, i.e., the Möbius group of the sphere \mathbb{S}^N (which can be considered as a compactification of \mathbb{R}^N by a point at infinity). Further, using the Clifford algebra model of the Möbius differential geometry enables us to give a frame description of orthogonal nets, which turns out to be a key technical device.

In this formalism, the ambient space for points and hyperspheres of the conformal N -sphere is the projectivized Minkowski space

$\mathbb{P}(\mathbb{R}^{N+1,1})$. The standard basis of the Minkowski space $\mathbb{R}^{N+1,1}$ is denoted by $\{\mathbf{e}_1, \dots, \mathbf{e}_{N+2}\}$. We denote also $\mathbf{e}_0 = \frac{1}{2}(\mathbf{e}_{N+2} + \mathbf{e}_{N+1})$ and $\mathbf{e}_\infty = \frac{1}{2}(\mathbf{e}_{N+2} - \mathbf{e}_{N+1})$. The points of the conformal N -sphere are elements of the projectivized light cone $\mathbb{P}(\mathbb{L}^{N+1})$, i.e., straight line generators of \mathbb{L}^{N+1} . The Euclidean space \mathbb{R}^N is identified, via

$$\pi_0 : \mathbb{R}^N \ni f \mapsto \hat{f} = f + \mathbf{e}_0 + |f|^2 \mathbf{e}_\infty \in \mathbb{Q}_0^N, \quad (1.29)$$

with the section \mathbb{Q}_0^N of the cone \mathbb{L}^{N+1} by the affine hyperplane $\{\xi_0 = 1\}$, where ξ_0 is the \mathbf{e}_0 -component of $\xi \in \mathbb{R}^{N+1,1}$ in the basis $\{\mathbf{e}_1, \dots, \mathbf{e}_N, \mathbf{e}_0, \mathbf{e}_\infty\}$. Orientation preserving Euclidean motions of \mathbb{R}^N are represented as conjugations by elements of \mathcal{H}_∞ , the isotropy subgroup of \mathbf{e}_∞ in $\text{Spin}^+(N+1, 1)$.

It is not difficult to derive the following nice characterization of orthogonal nets, due to Darboux (its second half follows directly from eq. (1.29)).

Theorem 1.7 *A conjugate net $f : \mathbb{R}^m \rightarrow \mathbb{R}^N$ is orthogonal, if and only if $|f|^2$ satisfies the same equation (1.1) as f does, in other words, if the corresponding $\hat{f} = \pi_0 \circ f : \mathbb{R}^m \rightarrow \mathbb{Q}_0^N$ is a conjugate net in $\mathbb{R}^{N+1,1}$.*

As easily seen, metric coefficients $h_i = |\partial_i f|$ satisfy also $h_i = |\partial_i \hat{f}|$. Hence, vectors $\hat{v}_i = h_i^{-1} \partial_i \hat{f} = v_i + 2\langle f, v_i \rangle \mathbf{e}_\infty$ have the (Lorentz) length 1. Since $\langle \hat{f}, \hat{f} \rangle = 0$, one readily finds that $\langle \hat{f}, \hat{v}_i \rangle = 0$ and $h_i = -\langle \partial_i \hat{v}_i, \hat{f} \rangle$.

Theorem 1.8 (Spinor frame of an O-net) *For an orthogonal net $f : \mathbb{R}^m \rightarrow \mathbb{R}^N$, i.e., for the corresponding conjugate net $\hat{f} : \mathbb{R}^m \rightarrow \mathbb{Q}_0^N$, there exists a function $\psi : \mathbb{R}^m \rightarrow \mathcal{H}_\infty$ (called a frame of \hat{f}), such that*

$$\hat{f} = \psi^{-1} \mathbf{e}_0 \psi, \quad (1.30)$$

$$\hat{v}_i = \psi^{-1} \mathbf{e}_i \psi, \quad 1 \leq i \leq m, \quad (1.31)$$

and satisfying the system of differential equations:

$$\partial_i \psi = -\mathbf{e}_i \psi \hat{s}_i, \quad \hat{s}_i = \frac{1}{2} \partial_i \hat{v}_i, \quad 1 \leq i \leq m. \quad (1.32)$$

Note that for an orthogonal coordinate system ($m = N$) the frame ψ is uniquely determined at any point by the requirements (1.30) and (1.31).

It is readily seen that the unit tangent vectors \hat{v}_i satisfy eq. (1.7) with the same rotation coefficients $\beta_{ji} = \langle \partial_i \hat{v}_j, \hat{v}_i \rangle = -\langle \partial_i \hat{v}_i, \hat{v}_j \rangle$. With the help of the frame ψ we extend the set of vectors $\{\hat{v}_i : 1 \leq i \leq m\}$ to an orthonormal basis $\{\hat{v}_k : 1 \leq k \leq N\}$ of $T_{\hat{f}} \mathbb{Q}_0^N$:

$$\hat{v}_k = \psi^{-1} \mathbf{e}_k \psi, \quad 1 \leq k \leq N. \quad (1.33)$$

Correspondingly, we extend the set of rotation coefficients according to the formula

$$\beta_{ki} = \langle \partial_i \hat{v}_k, \hat{v}_i \rangle = -\langle \partial_i \hat{v}_i, \hat{v}_k \rangle = -\langle \partial_i \hat{v}_i, \psi^{-1} \mathbf{e}_k \psi \rangle, \quad 1 \leq i \leq m, \quad 1 \leq k \leq N.$$

Recall that we also have:

$$h_i = -\langle \partial_i \hat{v}_i, \hat{f} \rangle = -\langle \partial_i \hat{v}_i, \psi^{-1} \mathbf{e}_0 \psi \rangle, \quad 1 \leq i \leq m.$$

Thus, introducing vectors $S_i = \psi \hat{s}_i \psi^{-1}$, we have the following expansion with respect to the vectors \mathbf{e}_k :

$$S_i = \psi \hat{s}_i \psi^{-1} = \frac{1}{2} \psi (\partial_i \hat{v}_i) \psi^{-1} = -\frac{1}{2} \sum_{k \neq i} \beta_{ki} \mathbf{e}_k + h_i \mathbf{e}_\infty. \quad (1.34)$$

It is easy to see that eq. (1.9) still holds, if the range of the indices is extended to all pairwise distinct with $1 \leq i, j \leq m$ and $1 \leq k \leq N$, and that the orthogonality constraint (1.24) can be now put as

$$\partial_i \beta_{ij} + \partial_j \beta_{ji} = - \sum_{k \neq i, j} \beta_{ki} \beta_{kj}. \quad (1.35)$$

The system consisting of (1.9), (1.35) carries the name of the *Lamé system*.

1.3 Moutard nets and their transformations

We introduce now Moutard nets [Mou] without a geometric motivation, but they will play an extremely important role in the subsequent geometric considerations.

Definition 1.9 *A map $f : \mathbb{R}^2 \rightarrow \mathbb{R}^N$ is called an M-net (Moutard net), if it satisfies the Moutard differential equation*

$$\partial_1 \partial_2 f = q_{12} f \quad (1.36)$$

with some $q_{12} : \mathbb{R}^2 \rightarrow \mathbb{R}$.

On the first sight, the notion of M-net is not related to that of a conjugate net. In particular, there do not exist M -dimensional M-nets with $M \geq 3$. However, the relation is easily established: if $\nu : \mathbb{R}^2 \rightarrow \mathbb{R}$ is any solution of the same Moutard equation (1.36) (for instance, any component of the vector f), then $y = \nu^{-1} f : \mathbb{R}^2 \rightarrow \mathbb{R}^N$ is a special conjugate net in \mathbb{R}^N :

$$\partial_1 \partial_2 y = -(\partial_2 \log \nu) \partial_1 y - (\partial_1 \log \nu) \partial_2 y.$$

Such nets y are called *conjugate nets with equal invariants*, and they were intensively studied in the classical projective differential geometry [Tzi]. Thus, in a projective space the class of M-nets coincides with the class of conjugate nets with equal invariants.

Following data determine an M-net f uniquely:

- (M₁) values of f on the coordinate axes $\mathcal{B}_1, \mathcal{B}_2$, i.e., two smooth curves $f|_{\mathcal{B}_i}$ with a common intersection point $f(0)$;
- (M₂) a smooth function $q_{12} : \mathbb{R}^2 \rightarrow \mathbb{R}$, having the meaning of the coefficient of the Moutard equation.

Definition 1.10 *Two M-nets $f, f^+ : \mathbb{R}^2 \rightarrow \mathbb{R}^N$ are called Moutard transforms of one another, if they satisfy (linear) differential equations*

$$\partial_1 f^+ + \partial_1 f = p_1(f^+ - f), \quad (1.37)$$

$$\partial_2 f^+ - \partial_2 f = p_2(f^+ + f), \quad (1.38)$$

with some functions $p_1, p_2 : \mathbb{R}^2 \rightarrow \mathbb{R}$ (or similar equations with all plus and minus signs interchanged).

The functions p_1, p_2 , specifying the Moutard transform, have to satisfy (nonlinear) differential equations, which express compatibility of eqs. (1.37), (1.38) with eq. (1.36):

$$\partial_1 p_2 = \partial_2 p_1 = -q_{12} + p_1 p_2, \quad (1.39)$$

$$q_{12}^+ = -q_{12} + 2p_1 p_2. \quad (1.40)$$

Following data determine a Moutard transform f^+ of a given M-net f :

- (MT₁) a point $f^+(0) \in \mathbb{R}^N$;
- (MT₂) values of the functions p_i on the coordinate axes \mathcal{B}_i for $i = 1, 2$, i.e., two smooth functions $p_i|_{\mathcal{B}_i}$ of one variable.

Classical formulation of the Moutard transformation. Due to the first equation in (1.39), for any Moutard transformation there exists a function $\theta : \mathbb{R}^2 \rightarrow \mathbb{R}$, unique up to a constant factor, such that

$$p_1 = -\frac{\partial_1 \theta}{\theta}, \quad p_2 = -\frac{\partial_2 \theta}{\theta}. \quad (1.41)$$

The last equation in (1.39) implies that θ satisfies eq. (1.36). This scalar solution of eq. (1.36) can be specified by its values on the coordinate axes \mathcal{B}_i ($i = 1, 2$), which are readily obtained from the data (MT₂) by integrating the corresponding eqs. (1.41). This establishes a bridge to the classical formulation of the Moutard transformation (see, e.g., [Mou, Tzi]). They used to specify a Moutard transform f^+ of the solution f of the Moutard equation (1.36) by an additional scalar solution θ of this equation, via eqs.

(1.37), (1.38) with (1.41). From these equations one can conclude that f^+ solves the Moutard equation (1.36) with the transformed potential

$$q_{12}^+ = q - 2\partial_1\partial_2 \log \theta = \frac{\partial_1\partial_2\theta^+}{\theta^+}, \quad \theta^+ = \frac{1}{\theta}. \quad (1.42)$$

In our formulation, the origin of the function θ becomes clear: it comes from p_1, p_2 by integrating the system (1.41). Eq. (1.42) is then nothing but an equivalent form of eq. (1.40).

Theorem 1.11 (Permutability of Moutard transformations)

1) Let f be an M-net, and let $f^{(1)}$ and $f^{(2)}$ be its two Moutard transforms. Then there exists a one-parameter family of M-nets $f^{(12)}$ that are Moutard transforms of both $f^{(1)}$ and $f^{(2)}$.

2) Let f be an M-net. Let $f^{(1)}, f^{(2)}$ and $f^{(3)}$ be its three Moutard transforms, and let three further M-nets $f^{(12)}, f^{(23)}$ and $f^{(13)}$ be given such that $f^{(ij)}$ is a simultaneous Moutard transform of $f^{(i)}$ and $f^{(j)}$. Then there exists generically a unique M-net $f^{(123)}$ that is a Moutard transform of $f^{(12)}, f^{(23)}$ and $f^{(13)}$.

1.4 Asymptotic nets and their transformations

Definition 1.12 A map $f : \mathbb{R}^2 \rightarrow \mathbb{R}^3$ is called an A-surface (a surface parametrized along asymptotic lines), if at any point the vectors $\partial_1^2 f, \partial_2^2 f$ lie in the tangent plane to the surface f , spanned by $\partial_1 f, \partial_2 f$.

Thus, the second fundamental form of an A-surface in \mathbb{R}^3 is off-diagonal. Such a parametrization exists for a general surface with a negative Gaussian curvature. Definition 1.12, like the definition of conjugate nets, contains projectively invariant notions only. Therefore A-surfaces belong actually to the geometry of the three-dimensional projective space. In our presentation, however, we will use for convenience additional structures of \mathbb{R}^3 (Euclidean structure and the cross-product). For the projective interpretation of these constructions, see [KoP]. A convenient description of A-surfaces is provided by the *Lelievre representation* which states: there exists a unique (up to sign) normal field $n : \mathbb{R}^2 \rightarrow \mathbb{R}^3$ to the surface f such that

$$\partial_1 f = \partial_1 n \times n, \quad \partial_2 f = n \times \partial_2 n. \quad (1.43)$$

Cross-differentiation of eq. (1.43) reveals that $\partial_1\partial_2 n \times n = 0$, that is, the Lelievre normal field satisfies the *Moutard equation*

$$\partial_1\partial_2 n = q_{12}n \quad (1.44)$$

with some $q_{12} : \mathbb{R}^2 \rightarrow \mathbb{R}$. This reasoning can be reversed: integration of eqs. (1.43) with any solution $n : \mathbb{R}^2 \rightarrow \mathbb{R}^3$ of the Moutard equation generates an A-surface $f : \mathbb{R}^2 \rightarrow \mathbb{R}^3$.

Theorem 1.13 *A-surfaces in \mathbb{R}^3 are in a one-to-one correspondence, via the Lelievre representation (1.43), with M-nets in \mathbb{R}^3 .*

An A-surface f is reconstructed uniquely (up to a translation) from its Lelievre normal field n . In its turn, an M-net n is uniquely determined by the initial data $(M_{1,2})$, which we denote in this context by $(A_{1,2})$:

- (A₁) values of the Lelievre normal field on the coordinate axes $\mathcal{B}_1, \mathcal{B}_2$, i.e., two smooth curves $n|_{\mathcal{B}_i}$ with a common intersection point $n(0)$;
- (A₂) a smooth function $q_{12} : \mathbb{R}^2 \rightarrow \mathbb{R}$, having the meaning of the coefficient of the Moutard equation for n .

Definition 1.14 *A pair of A-surfaces $f, f^+ : \mathbb{R}^2 \rightarrow \mathbb{R}^3$ is called a Weingarten pair, if, for any $u \in \mathbb{R}^2$, the line $[f(u), f^+(u)]$ is tangent to both surfaces f and f^+ at the corresponding points. The surface f^+ is called a Weingarten transform of the surface f .*

It can be demonstrated that the Lelievre normal fields of a Weingarten pair f, f^+ of A-surfaces satisfy (with the suitable choice of their signs) the following relation:

$$f^+ - f = n^+ \times n. \quad (1.45)$$

Differentiating the last equation and using the Lelievre formulas (1.43) for f and for f^+ , one easily sees that the normal fields of a Weingarten pair are related by (linear) differential equations:

$$\partial_1 n^+ + \partial_1 n = p_1(n^+ - n), \quad (1.46)$$

$$\partial_2 n^+ - \partial_2 n = p_2(n^+ + n), \quad (1.47)$$

with some functions $p_1, p_2 : \mathbb{R}^2 \rightarrow \mathbb{R}$. Thus:

Theorem 1.15 *The Lelievre normal fields n, n^+ of a Weingarten pair f, f^+ of A-surfaces are Moutard transforms of one another.*

A Weingarten transform f^+ of a given A-surface f is reconstructed from a Moutard transform n^+ of the Lelievre normal field n . The data necessary for this are the data $(MT_{1,2})$ for n :

- (W₁) a point $n^+(0) \in \mathbb{R}^3$;

(W₂) values of the functions p_i on the coordinate axes \mathcal{B}_i for $i = 1, 2$, i.e., two smooth functions $p_i|_{\mathcal{B}_i}$ of one variable.

Following statement is a direct consequence of Theorem 1.11.

Theorem 1.16 (Permutability of Weingarten transformations)

1) Let f be an A -surface, and let $f^{(1)}$ and $f^{(2)}$ be its two Weingarten transforms. Then there exists a one-parameter family of A -surfaces $f^{(12)}$ that are Weingarten transforms of both $f^{(1)}$ and $f^{(2)}$.

2) Let f be an A -surface. Let $f^{(1)}$, $f^{(2)}$ and $f^{(3)}$ be its three Weingarten transforms, and let three further A -surfaces $f^{(12)}$, $f^{(23)}$ and $f^{(13)}$ be given such that $f^{(ij)}$ is a simultaneous Weingarten transform of $f^{(i)}$ and $f^{(j)}$. Then there exists generically a unique A -surface $f^{(123)}$ that is a Weingarten transform of $f^{(12)}$, $f^{(23)}$ and $f^{(13)}$. The net $f^{(123)}$ is uniquely defined by the condition that any its point lies in the tangent planes to $f^{(12)}$, $f^{(23)}$ and $f^{(13)}$ at the corresponding points.

1.5 Surfaces with constant negative Gaussian curvature and their transformations

Up to now, we discussed special classes of coordinate systems in space, or special parametrizations of a general surface. Now, we turn to the discussion of several special classes of surfaces. The distinctive feature of these classes is the existence of transformations with certain permutability properties.

Definition 1.17 An A -surface $f : \mathbb{R}^2 \rightarrow \mathbb{R}^3$ is called a K -surface (or a pseudospheric surface), if its Gaussian curvature K is constant, i.e., does not depend on $u \in \mathbb{R}^2$.

K -surfaces constitute one of the most prominent examples of integrability in the differential geometry. One of the approaches to their analytical study is based on the investigation of the angle between asymptotic lines which is governed by the famous sine-Gordon equation. This approach was transferred to the discrete setting in [BobP1], see also a presentation in [BobMaS1] based on the notion of consistency. In the present paper, we take an alternative route, based on the study of the Gauss map of K -surfaces. Following are the classical characterization results.

Theorem 1.18

1) An A -surface $f : \mathbb{R}^2 \rightarrow \mathbb{R}^3$ is a K -surface, if and only if the functions $|\partial_i f| = \alpha_i$ depend on u_i only ($i = 1, 2$).

2) The Lelievre normal field $n : \mathbb{R}^2 \rightarrow \mathbb{R}^3$ of a K -surface with $K = -1$ takes values in the sphere $\mathbb{S}^2 \subset \mathbb{R}^3$, thus coinciding with the Gauss map. Conversely, any M -net in the unit sphere \mathbb{S}^2 is the Gauss map and the Lelievre normal field of a K -surface with $K = -1$. There holds: $|\partial_i n| = \alpha_i$ for $i = 1, 2$, with the same functions $\alpha_i = \alpha_i(u_i)$ as in 1).

Thus, K -surfaces are in a one-to-one correspondence with M -nets in \mathbb{S}^2 (otherwise said, with Lorentz-harmonic \mathbb{S}^2 -valued functions). It is important to observe that the coefficient q_{12} of the Moutard equation satisfied by a Lorentz-harmonic \mathbb{S}^2 -valued function $n : \mathbb{R}^2 \rightarrow \mathbb{R}^3$ is completely determined by n , more precisely, by its first order derivatives:

$$q_{12} = \langle \partial_1 \partial_2 n, n \rangle = -\langle \partial_1 n, \partial_2 n \rangle. \quad (1.48)$$

Therefore, following data determine the Gauss map n of a K -surface f :

(K) values of the Gauss map on the coordinate axes $\mathcal{B}_1, \mathcal{B}_2$, i.e., two smooth curves $n|_{\mathcal{B}_i}$ in \mathbb{S}^2 intersecting at a point $n(0)$.

The K -surface f is reconstructed from n uniquely, up to a translation, via formulas (1.43).

Historically the first class of surface transformations with remarkable permutability properties was introduced by Bäcklund.

Definition 1.19 (Bäcklund transformation) *A Weingarten pair of K -surfaces $f, f^+ : \mathbb{R}^2 \rightarrow \mathbb{R}^N$ forms a Bäcklund pair, if the distance $|f^+ - f|$ is constant, i.e., does not depend on $u \in \mathbb{R}^2$.*

The Gauss maps n, n^+ of a Bäcklund pair of K -surfaces f, f^+ are related by the Moutard transformation (1.46), (1.47). From these equations there follows easily that for a Bäcklund pair the quantity $\langle n, n^+ \rangle$ is constant; thus, the intersection angle of the tangent planes at the corresponding points of a Bäcklund pair is constant. Moreover, eq. (1.45) yields that this constant angle is related to the constant distance between f and f^+ via

$$|f^+ - f|^2 = 1 - \langle n, n^+ \rangle^2.$$

The fact that $n, n^+ \in \mathbb{S}^2$ allows one to express the coefficients p_1, p_2 in eqs. (1.46), (1.47) in terms of the solutions themselves:

$$p_1 = \frac{\langle \partial_1 n, n^+ \rangle - \langle n, \partial_1 n^+ \rangle}{2 - 2\langle n, n^+ \rangle} = \frac{\langle \partial_1 n, n^+ \rangle}{1 - \langle n, n^+ \rangle}, \quad (1.49)$$

$$p_2 = \frac{\langle n, \partial_2 n^+ \rangle - \langle \partial_2 n, n^+ \rangle}{2 + 2\langle n, n^+ \rangle} = \frac{-\langle \partial_2 n, n^+ \rangle}{1 + \langle n, n^+ \rangle}. \quad (1.50)$$

With these expressions, eqs. (1.46), (1.47) become a compatible system of first order differential equations for n^+ , therefore the following data determine a Bäcklund transform f^+ of the given K-surface f uniquely:

(B) a point $n^+(0) \in \mathbb{S}^2$.

Permutability of Bäcklund transformations is due to Bianchi:

Theorem 1.20 (Permutability of Bäcklund transformations)

Let f be a K-surface, and let $f^{(1)}$ and $f^{(2)}$ be its two Bäcklund transforms. Then there exists a unique K-surface $f^{(12)}$ which is simultaneously a Bäcklund transform of $f^{(1)}$ and of $f^{(2)}$. The fourth surface $f^{(12)}$ is uniquely defined by the properties $|f^{(12)} - f^{(1)}| = |f^{(2)} - f|$ and $|f^{(12)} - f^{(2)}| = |f^{(1)} - f|$, or, in terms of the Gauss maps, $\langle n^{(1)}, n^{(12)} \rangle = \langle n, n^{(2)} \rangle$ and $\langle n^{(2)}, n^{(12)} \rangle = \langle n, n^{(1)} \rangle$. Equivalently, there holds one of the relations

$$n^{(12)} - n \parallel n^{(1)} - n^{(2)} \quad \text{or} \quad n^{(12)} + n \parallel n^{(1)} + n^{(2)}.$$

We will see how the theory of discrete K-surfaces unifies the theories of smooth K-surfaces and of their Bäcklund transformations.

1.6 Isothermic surfaces and their transformations

Classically, theory of isothermic surfaces and their transformations was considered as one of the highest achievements of the local differential geometry.

Definition 1.21 *An O-surface $f : \mathbb{R}^2 \rightarrow \mathbb{R}^N$ is called an I-surface (isothermic surface), if its first fundamental form is conformal, possibly upon a re-parametrization $u_i \rightarrow \varphi_i(u_i)$ ($i = 1, 2$) of the dependent variables, i.e., if at any point $u \in \mathbb{R}^2$ of the definition domain there holds $|\partial_1 f|^2 / |\partial_2 f|^2 = \alpha_1(u_1) / \alpha_2(u_2)$.*

In other words, isothermic surfaces are characterized by the relations $\partial_1 \partial_2 f \in \text{span}(\partial_1 f, \partial_2 f)$ and

$$\langle \partial_1 f, \partial_2 f \rangle = 0, \quad |\partial_1 f|^2 = \alpha_1 s^2, \quad |\partial_2 f|^2 = \alpha_2 s^2, \quad (1.51)$$

with some $s : \mathbb{R}^2 \rightarrow \mathbb{R}_+$ and with the functions α_i depending on u_i only ($i = 1, 2$). These conditions may be equivalently represented as

$$\partial_1 \partial_2 f = (\partial_2 \log s) \partial_1 f + (\partial_1 \log s) \partial_2 f, \quad \langle \partial_1 f, \partial_2 f \rangle = 0. \quad (1.52)$$

The following property of isothermic surfaces can actually serve as their another characterization.

Theorem 1.22 (Dual I-surface) *Let $f : \mathbb{R}^2 \rightarrow \mathbb{R}^N$ be an isothermic surface. Then the \mathbb{R}^N -valued one-form df^* defined by*

$$\partial_1 f^* = \alpha_1 \frac{\partial_1 f}{|\partial_1 f|^2} = \frac{\partial_1 f}{s^2}, \quad \partial_2 f^* = -\alpha_2 \frac{\partial_2 f}{|\partial_2 f|^2} = -\frac{\partial_2 f}{s^2}, \quad (1.53)$$

is closed. The surface $f^ : \mathbb{R}^2 \rightarrow \mathbb{R}^N$, defined (up to a translation) by the integration of this one-form, is isothermic, with*

$$\langle \partial_1 f^*, \partial_2 f^* \rangle = 0, \quad |\partial_1 f^*|^2 = \alpha_1 s^{-2}, \quad |\partial_2 f^*|^2 = \alpha_2 s^{-2}. \quad (1.54)$$

The surface f^ is called dual to the surface f , or the Christoffel transform of the surface f .*

Another important class of transformations of isothermic surfaces build the Darboux transformations.

Definition 1.23 (Darboux transformation) *A Ribaucour transform $f^+ : \mathbb{R}^2 \rightarrow \mathbb{R}^N$ of a given isothermic surface $f : \mathbb{R}^2 \rightarrow \mathbb{R}^N$ is called a Darboux transform, if its first fundamental form is likewise conformal, possibly upon a reparametrization of the dependent variables, i.e., if at any point $u \in \mathbb{R}^2$ of the definition domain there holds $|\partial_1 f^+|^2/|\partial_2 f^+|^2 = \alpha_1(u_1)/\alpha_2(u_2)$.*

Introduce the corresponding function $s^+ : \mathbb{R}^2 \rightarrow \mathbb{R}_+$ for the surface f^+ , and denote $r = s^+/s : \mathbb{R}^2 \rightarrow \mathbb{R}_+$. Thus, $|\partial_i f^+|^2/|\partial_i f|^2 = (s^+/s)^2 = r^2$ for $i = 1, 2$. Comparing this with the definition (1.25) of Ribaucour transformations we see that one of the two possibilities holds:

$$(i) \quad r_1 = r_2 = r, \quad \text{or} \quad (ii) \quad r_1 = -r_2 = -r.$$

It can be demonstrated that in the case (i) the surface f^+ is with necessity a Möbius transformation of f ; we will not consider this trivial case further. In the case (ii) one gets proper Darboux transformations. An important property of the Darboux transformations is the following: the quantity

$$c = \frac{\ell^2}{ss^+} = \frac{|f^+ - f|^2}{ss^+} \quad (1.55)$$

is constant, i.e., does not depend on $u \in \mathbb{R}^2$. It is called a *parameter* of the Darboux transformation. Following data determine a Darboux transform f^+ of a given isothermic surface f uniquely:

(D₁) a point $f^+(0)$;

(D₂) a real number c , designated to be the constant (1.55).

As usual, we regard iterating a Darboux transformation as adding a third (discrete) dimension to a two-dimensional isothermic net. The main classical result on Darboux transformations is the following theorem, which assures that one can add several discrete dimensions in a consistent way.

Theorem 1.24 (Permutability of Darboux transformations)

Let f be an isothermic surface, and let $f^{(1)}$ and $f^{(2)}$ be its two Darboux transforms, with parameters c_1 and c_2 , respectively. Then there exists a unique isothermic surface $f^{(12)}$ which is simultaneously a Darboux transform of $f^{(1)}$ with the parameter c_2 and a Darboux transform of $f^{(2)}$ with the parameter c_1 . The surface $f^{(12)}$ is uniquely defined by the condition that the corresponding points of the four isothermic surfaces are concircular, and have a constant cross-ratio

$$q(f, f^{(1)}, f^{(12)}, f^{(2)}) = \frac{c_1}{c_2}.$$

Remark. The real cross-ratio of four concircular points $a, b, c, d \in \mathbb{R}^N$ may be defined as

$$q(a, b, c, d) = (a - b)(b - c)^{-1}(c - d)(d - a)^{-1}, \quad (1.56)$$

where the points are interpreted as elements of the Clifford algebra $\mathcal{C}\ell(\mathbb{R}^N)$. In more down-to-earth terms, since the four points are co-planar, we may identify the plane where they lie with the complex plane, and interpret in the above formula the symbols a, b, c, d as complex numbers.

The theory of discrete isothermic surfaces unifies the theories of smooth isothermic surfaces and of their Darboux transformations.

Möbius-geometric characterization of isothermic surfaces and their Darboux transformations. It is easily checked that conditions (1.51) are invariant with respect to affine transformations of \mathbb{R}^N , as well as with respect to the inversion $f \rightarrow f/\langle f, f \rangle$. In other words, the notion of isothermic surfaces belongs to the Möbius differential geometry. The same holds for their Darboux transformations. Therefore, it is useful to characterize these notions within the Möbius-geometric formalism. (However, the notion of the dual surface, or Christoffel transformation, is essentially based on the Euclidean structure of the ambient space \mathbb{R}^N .)

To find such a characterization, note first of all that eqs. (1.52) are equivalent to

$$\partial_1 \partial_2 \hat{f} = (\partial_2 \log s) \partial_1 \hat{f} + (\partial_1 \log s) \partial_2 \hat{f}$$

for the image $\hat{f} : \mathbb{R}^2 \rightarrow \mathbb{Q}_0^N$ of f in the quadric $\mathbb{Q}_0^N \subset \mathbb{L}^{N+1}$.

Theorem 1.25 *The lift $\hat{s} = s^{-1}\hat{f} : \mathbb{R}^2 \rightarrow \mathbb{L}^{N+1}$ of an isothermic surface $f : \mathbb{R}^2 \rightarrow \mathbb{R}^N$ to the light cone of $\mathbb{R}^{N+1,1}$ satisfies the Moutard equation*

$$\partial_1\partial_2\hat{s} = q_{12}\hat{s}, \quad (1.57)$$

with $q_{12} = s\partial_1\partial_2(s^{-1})$.

Conversely, given an M-net $\hat{s} : \mathbb{R}^2 \rightarrow \mathbb{L}^{N+1}$ in the light cone, define $s : \mathbb{R}^2 \rightarrow \mathbb{R}_+$ and $f : \mathbb{R}^2 \rightarrow \mathbb{R}^N$ by

$$\hat{s} = s^{-1}(f + \mathbf{e}_0 + |f|^2\mathbf{e}_\infty)$$

(so that s^{-1} is the \mathbf{e}_0 -component, and $s^{-1}f$ is the \mathbb{R}^N -part of \hat{s} in the basis $\mathbf{e}_1, \dots, \mathbf{e}_N, \mathbf{e}_0, \mathbf{e}_\infty$). Then f is an isothermic surface.

Note that the functions $\alpha_i = \langle \partial_i\hat{s}, \partial_i\hat{s} \rangle$ ($i = 1, 2$) depend on u_i only and coincide with the namesake functions from the definition (1.51).

Thus, we see that *I-surfaces are in a one-to-one correspondence with M-nets in \mathbb{L}^{N+1} , i.e., with Lorentz-harmonic \mathbb{L}^{N+1} -valued functions.*

Let us address the problem of minimal data which determine an isothermic surface (i.e., an M-net in \mathbb{L}^{N+1}) uniquely. Guided by an analogy with the case of K-surfaces, one is tempted to think that two arbitrary curves $\hat{s}|_{\mathcal{B}_i}$ in \mathbb{L}^{N+1} would be such data. However, as a consequence of the fact that now we are dealing with the light cone $\mathbb{L}^{N+1} = \{\langle \hat{s}, \hat{s} \rangle = 0\}$ rather than with the sphere $\mathbb{S}^2 = \{\langle n, n \rangle = 1\}$ as a quadric where M-nets live, we cannot find an expression for q_{12} in terms of the first derivatives of \hat{s} anymore; instead, one has:

$$q_{12} = \frac{\langle \partial_1^3\hat{s}, \partial_2\hat{s} \rangle}{\langle \partial_1\hat{s}, \partial_1\hat{s} \rangle} = \frac{\langle \partial_2^3\hat{s}, \partial_1\hat{s} \rangle}{\langle \partial_2\hat{s}, \partial_2\hat{s} \rangle}.$$

This shows that the coordinate curves $\hat{s}|_{\mathcal{B}_i}$ are not arbitrary but rather subject to certain further conditions. We leave the question on correct initial data for an isothermic surface open.

Darboux pairs of isothermic surfaces are characterized in terms of their lifts as follows.

Theorem 1.26 *The lifts $\hat{s}, \hat{s}^+ : \mathbb{R}^2 \rightarrow \mathbb{L}^{N+1}$ of a Darboux pair of isothermic surfaces $f, f^+ : \mathbb{R}^2 \rightarrow \mathbb{R}^N$ are related by a Moutard transformation, i.e., there exist two functions $p_1, p_2 : \mathbb{R}^2 \rightarrow \mathbb{R}$ such that*

$$\partial_1\hat{s}^+ + \partial_1\hat{s} = p_1(\hat{s}^+ - \hat{s}), \quad \partial_2\hat{s}^+ - \partial_2\hat{s} = p_2(\hat{s}^+ + \hat{s}). \quad (1.58)$$

Conversely, for an M-net \hat{s} in \mathbb{L}^{N+1} , any Moutard transform \hat{s}^+ with values in \mathbb{L}^{N+1} is a lift of a Darboux transform f^+ of the isothermic surface f .

Note that the quantity $\langle \hat{s}, \hat{s}^+ \rangle$ is constant (does not depend on $u \in \mathbb{R}^2$), and is related to the parameter c of the Darboux transformation: $\langle \hat{s}, \hat{s}^+ \rangle = -c/2$. The formulas

$$p_i = \frac{\langle \hat{s}, \partial_i \hat{s}^+ \rangle - \langle \partial_i \hat{s}, \hat{s}^+ \rangle}{2\langle \hat{s}, \hat{s}^+ \rangle} = -\frac{\langle \partial_i \hat{s}, \hat{s}^+ \rangle}{\langle \hat{s}, \hat{s}^+ \rangle}, \quad i = 1, 2, \quad (1.59)$$

make it apparent that a Moutard transform \hat{s}^+ is completely determined by prescribing its value $\hat{s}^+(0)$ at one point. Indeed, eqs. (1.58) with coefficients (1.59) form a compatible system of first order differential equations for $\hat{s}^+ : \mathbb{R}^2 \rightarrow \mathbb{L}^{N+1}$. Of course, data $(D_{1,2})$ are encoded in $\hat{s}^+(0)$ in a straightforward manner.

We summarize the considerations of these chapter in the following table:

$$\begin{aligned} \text{O-net } f \text{ in } \mathbb{R}^N &\leftrightarrow \text{conjugate net } \hat{f} \text{ in } \mathbb{Q}_0^N \simeq \mathbb{P}(\mathbb{L}^{N+1}), \\ \text{A-net } f \text{ in } \mathbb{R}^3 &\leftrightarrow \text{M-net } n \text{ in } \mathbb{R}^3, \\ \text{K-net } f \text{ in } \mathbb{R}^3 &\leftrightarrow \text{M-net } n \text{ in } \mathbb{S}^2, \\ \text{I-net } f \text{ in } \mathbb{R}^N &\leftrightarrow \text{M-net } \hat{s} \text{ in } \mathbb{L}^{N+1}. \end{aligned}$$

The next chapter will be devoted to discretizing all these relations.

Appendix: Möbius-geometric formalism

The classical model of the N -dimensional Möbius geometry, which allows for a linear representation of Möbius transformations, lives in the Minkowski space $\mathbb{R}^{N+1,1}$, i.e., in an $(N+2)$ -dimensional space with the basis $\{\mathbf{e}_1, \dots, \mathbf{e}_{N+2}\}$, equipped with the Lorentz scalar product in which \mathbf{e}_i are pairwise orthogonal and

$$\langle \mathbf{e}_i, \mathbf{e}_i \rangle = \begin{cases} 1, & 1 \leq i \leq N+1, \\ -1, & i = N+2. \end{cases}$$

(Although we use the same symbol for the Lorentz scalar product in $\mathbb{R}^{N+1,1}$ and for the Euclidean scalar products in \mathbb{R}^N and in \mathbb{R}^{N+1} , its concrete meaning should be always clear from the context.)

Points. The space of points in the Möbius geometry is $\mathbb{P}(\mathbb{L}^{N+1})$ – the space of straight line generators of the *light cone*

$$\mathbb{L}^{N+1} = \{\xi \in \mathbb{R}^{N+1,1} : \langle \xi, \xi \rangle = 0\}. \quad (1.60)$$

The sphere $\mathbb{S}^N \subset \mathbb{R}^{N+1}$ (where we regard \mathbb{R}^{N+1} as spanned by $\mathbf{e}_1, \dots, \mathbf{e}_{N+1}$) is identified with a section of \mathbb{L}^{N+1} by the affine hyperplane $\langle \xi, \mathbf{e}_{N+2} \rangle = -1$:

$$\mathbb{S}^N \simeq \mathbb{Q}_1^N = \{\xi \in \mathbb{L}^{N+1} : \xi_{N+2} = 1\},$$

which is a copy of \mathbb{S}^N shifted by \mathbf{e}_{N+2} :

$$\pi_1 : \mathbb{S}^N \ni y \mapsto \hat{y} = \hat{y}_{\text{Sph}} = y + \mathbf{e}_{N+2} \in \mathbb{Q}_1^N. \quad (1.61)$$

Similarly, the Euclidean space \mathbb{R}^N may be identified with the section of \mathbb{L}^{N+1} by the affine hyperplane $\langle \xi, \mathbf{e}_{N+2} - \mathbf{e}_{N+1} \rangle = -1$,

$$\mathbb{R}^N \simeq \mathbb{Q}_0^N = \{\xi \in \mathbb{L}^{N+1} : \xi_{N+1} + \xi_{N+2} = 1\},$$

(Euclidean metric $d\xi_1^2 + \dots + d\xi_N^2$, being induced from the ambient $\mathbb{R}^{N+1,1}$):

$$\begin{aligned} \pi_0 : \mathbb{R}^N \ni x &\mapsto \hat{x} = \hat{x}_{\text{Euc}} = x + \frac{1}{2}(1 - |x|^2)\mathbf{e}_{N+1} + \frac{1}{2}(1 + |x|^2)\mathbf{e}_{N+2} \\ &= x + \mathbf{e}_0 + |x|^2\mathbf{e}_\infty \in \mathbb{Q}_0^N. \end{aligned} \quad (1.62)$$

Here the following notations are introduced:

$$\mathbf{e}_0 = \frac{1}{2}(\mathbf{e}_{N+2} + \mathbf{e}_{N+1}) \quad \text{and} \quad \mathbf{e}_\infty = \frac{1}{2}(\mathbf{e}_{N+2} - \mathbf{e}_{N+1}).$$

Thus, the space \mathbb{R}^N is modelled as a paraboloid in an $(N+1)$ -dimensional affine subspace through \mathbf{e}_0 spanned by $\mathbf{e}_1, \dots, \mathbf{e}_N, \mathbf{e}_\infty$. An important property of the Euclidean identification (1.62) is:

$$\langle \hat{x}_1, \hat{x}_2 \rangle = -\frac{1}{2}|x_1 - x_2|^2, \quad \forall x_1, x_2 \in \mathbb{R}^N. \quad (1.63)$$

Note that the correspondence between \mathbb{Q}_1^N and \mathbb{Q}_0^N along the straight line generators of \mathbb{L}^{N+1} induces the stereographic projection $\sigma : \mathbb{S}^N \rightarrow \mathbb{R}^N$,

$$y = \sigma^{-1}(x) = \frac{2}{1 + |x|^2} x + \frac{1 - |x|^2}{1 + |x|^2} \mathbf{e}_{N+1}.$$

In particular, the generators of \mathbb{L}^{N+1} through the points \mathbf{e}_0 and \mathbf{e}_∞ correspond to the north pole $y_0 = \mathbf{e}_{N+1}$ and the south pole $y_\infty = -\mathbf{e}_{N+1}$ on \mathbb{S}^N , and to the zero and the point at infinity in \mathbb{R}^N , respectively.

Spheres. A hypersphere S in the conformal N -sphere is the (non-empty) intersection of $\mathbb{P}(\mathbb{L}^{N+1})$ with a projectivized hyperplane. Thus, S can be put into a correspondence with the point $S \in \mathbb{P}(\mathbb{R}^{N+1,1})$ polar to the above mentioned hyperplane with respect to the light cone. This point is space-like, i.e., any its representative $\hat{s} \in \mathbb{R}^{N+1,1}$ has $\langle \hat{s}, \hat{s} \rangle > 0$. There are

various choices of this representative which have nice geometric interpretations.

Fixing the \mathbf{e}_{N+2} -component of \hat{s} leads to the choice

$$\hat{s} = \hat{s}_{\text{Sph}} = s + \mathbf{e}_{N+2}, \quad \text{with } s \in \mathbb{R}^{N+1}, \quad \langle s, s \rangle > 1. \quad (1.64)$$

This is related to a description of the hypersphere $S \subset \mathbb{S}^N$ as the intersection of \mathbb{S}^N with the hyperplane $\langle s, y \rangle = 1$ in \mathbb{R}^{N+1} . Indeed, the latter equation is equivalent to $\langle \hat{s}, \hat{y} \rangle = 0$ for \hat{y} from eq. (1.61). The point s lies outside of \mathbb{S}^N , and $S \subset \mathbb{S}^N$ is the contact set of \mathbb{S}^N with the tangent cone to \mathbb{S}^N with the apex s . Also, $S \subset \mathbb{S}^N$ is the intersection of \mathbb{S}^N with the orthogonal N -sphere in \mathbb{R}^{N+1} with the center s and the radius $\rho = (\langle s, s \rangle - 1)^{1/2}$. See Fig. 6.2.

Fixing the \mathbf{e}_0 -component of \hat{s} leads to the choice

$$\hat{s} = \hat{s}_{\text{Euc}} = c + \mathbf{e}_0 + (|c|^2 - r^2)\mathbf{e}_\infty, \quad \text{where } c \in \mathbb{R}^N, \quad (1.65)$$

related to the Euclidean description of the hypersphere $S \subset \mathbb{R}^N$. Indeed, $\langle \hat{s}, \hat{x} \rangle = 0$ for \hat{x} from eq. (1.62) is equivalent to $|x - c|^2 = r^2$. This is the equation for points x of the sphere S with the Euclidean center c and the Euclidean radius r .

Still another choice is to fix the Lorentz norm of \hat{s} :

$$\hat{s} = \hat{s}_{\text{Möb}} = \pm \frac{\kappa}{\rho}(s + \mathbf{e}_{N+2}) = \pm \frac{\kappa}{r}(c + \mathbf{e}_0 + (|c|^2 - r^2)\mathbf{e}_\infty) \in \mathbb{L}_\kappa^{N+1}, \quad (1.66)$$

where for any $\kappa > 0$ the following quadric is introduced:

$$\mathbb{L}_\kappa^{N+1} = \{\xi \in \mathbb{R}^{N+1,1} : \langle \xi, \xi \rangle = \kappa^2\}. \quad (1.67)$$

Actually, this represents *oriented hyperspheres*, each choice of the sign \pm corresponding to one of the two possible orientations of a given hypersphere. For any two (oriented) hyperspheres S_1, S_2 the scalar product of their representatives $\hat{s}_{\text{Möb}}$ is a Möbius invariant: if $\kappa = 1$, then

$$\langle \hat{s}_1, \hat{s}_2 \rangle = \frac{1}{\rho_1 \rho_2} (\langle s_1, s_2 \rangle - 1) = \frac{1}{2r_1 r_2} (r_1^2 + r_2^2 - |c_1 - c_2|^2),$$

is the cosine of the intersection angle of S_1, S_2 , if they intersect, and the inversive distance between S_1, S_2 , otherwise.

Transformations. Elements of the group $\mathbf{O}^+(N+1, 1)$, i.e., Lorentz transformations preserving the time-like direction, induce Möbius transformations on $\mathbb{Q}_1^N \simeq \mathbb{S}^N$. Therefore we identify $\mathbf{O}^+(N+1, 1)$ with the group

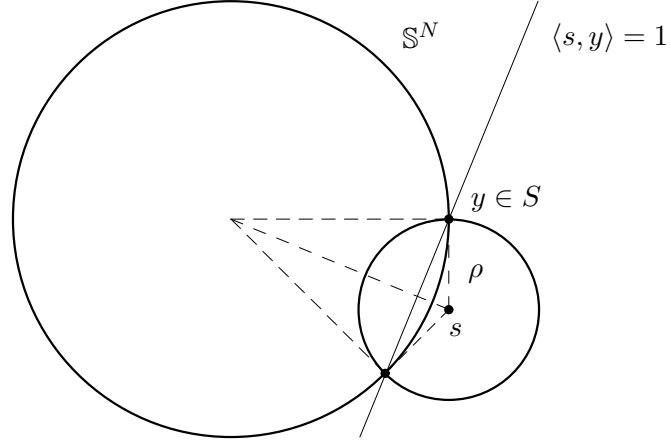

Figure 1.1: Hypersphere $S \subset \mathbb{S}^N$, with an orthogonal N -sphere through S

$M(N)$ of Möbius transformations of \mathbb{S}^N . Similarly, Lorentz transformations which fix \mathbf{e}_∞ , induce Euclidean motions on $\mathbb{Q}_0^N \simeq \mathbb{R}^N$, and therefore we identify the corresponding isotropy subgroup $O_\infty^+(N+1, 1)$ with $E(N)$, the group of Euclidean motions of \mathbb{R}^N .

It is convenient to work with spinor representations of these groups. Recall that the Clifford algebra $\mathcal{C}\ell(N+1, 1)$ is an algebra over \mathbb{R} with generators $\mathbf{e}_1, \dots, \mathbf{e}_{N+2} \in \mathbb{R}^{N+1,1}$ subject to the relation

$$\xi\eta + \eta\xi = -2\langle\xi, \eta\rangle\mathbf{1} = -2\langle\xi, \eta\rangle, \quad \forall\xi, \eta \in \mathbb{R}^{N+1,1}.$$

This implies that $\xi^2 = -\langle\xi, \xi\rangle$, therefore any vector $\xi \in \mathbb{R}^{N+1,1} \setminus \mathbb{L}^{N+1}$ has an inverse $\xi^{-1} = -\xi/\langle\xi, \xi\rangle$. The multiplicative group generated by invertible vectors is called the *Clifford group*. We need its subgroup generated by unit space-like vectors:

$$\mathcal{G} = \text{Pin}^+(N+1, 1) = \{\psi = \xi_1 \cdots \xi_n : \xi_i^2 = -1\},$$

and its subgroup generated by vectors orthogonal to \mathbf{e}_∞ :

$$\mathcal{G}_\infty = \text{Pin}_\infty^+(N+1, 1) = \{\psi = \xi_1 \cdots \xi_n : \xi_i^2 = -1, \langle\xi_i, \mathbf{e}_\infty\rangle = 0\}.$$

These groups act on $\mathbb{R}^{N+1,1}$ by twisted conjugations: $A_\psi(\eta) = (-1)^n \psi^{-1} \eta \psi$. In particular, for a vector ξ with $\xi^2 = -1$ one has:

$$A_\xi(\eta) = -\xi^{-1} \eta \xi = \xi \eta \xi = \eta - 2\langle\xi, \eta\rangle\xi,$$

which is the reflection in the hyperplane orthogonal to ξ . Thus, \mathcal{G} is generated by reflections, while \mathcal{G}_∞ is generated by reflections which fix \mathbf{e}_∞ , and therefore leave \mathbb{Q}_0^N invariant. Actually, \mathcal{G} is a double cover of $\mathrm{O}^+(N+1, 1) \simeq \mathrm{M}(N)$, while \mathcal{G}_∞ is a double cover of $\mathrm{O}^+(N+1, 1)_\infty \simeq \mathrm{E}(N)$. Orientation preserving transformations from \mathcal{G} , \mathcal{G}_∞ form the subgroups

$$\mathcal{H} = \mathrm{Spin}^+(N+1, 1), \quad \mathcal{H}_\infty = \mathrm{Spin}_\infty^+(N+1, 1),$$

which are singled out by the condition that the number n of vectors ξ_i in the multiplicative representation of their elements $\psi = \xi_1 \cdots \xi_n$ is even. The Lie algebras of the Lie groups \mathcal{H} and \mathcal{H}_∞ consist of bivectors:

$$\begin{aligned} \mathfrak{h} &= \mathrm{spin}(N+1, 1) = \mathrm{span}\left\{\mathbf{e}_i \mathbf{e}_j : i, j \in \{0, 1, \dots, N, \infty\}, i \neq j\right\}, \\ \mathfrak{h}_\infty &= \mathrm{spin}_\infty(N+1, 1) = \mathrm{span}\left\{\mathbf{e}_i \mathbf{e}_j : i, j \in \{1, \dots, N, \infty\}, i \neq j\right\}. \end{aligned}$$

Chapter 2

Discrete differential geometry

For functions on \mathbb{Z}^M , we define translation and difference operators in a standard manner:

$$(\tau_i f)(u) = f(u + e_i), \quad (\delta_i f)(u) = f(u + e_i) - f(u),$$

where e_i is the i -th coordinate vector of \mathbb{Z}^M . We use the same notation for (discrete) s -dimensional coordinate planes,

$$\mathcal{B}_{i_1 \dots i_s} = \{u \in \mathbb{Z}^M : u_i = 0 \text{ for } i \neq i_1, \dots, i_s\},$$

as in the continuous case.

2.1 Discrete conjugate nets

The following definition is due to Sauer [Sa] for $M = 2$, and to Doliwa and Santini [DoS1] for general M . See [Do1, Do2, Do3, Do5, DoSM, MDS] for further relevant developments.

Definition 2.1 *A map $f : \mathbb{Z}^M \rightarrow \mathbb{R}^N$ is called an M -dimensional Q-net (quadrilateral net, or discrete conjugate net) in \mathbb{R}^N , if any of its elementary quadrilaterals is planar, i.e., if at any $u \in \mathbb{Z}^M$ and for all pairs $1 \leq i \neq j \leq M$ the four points f , $\tau_i f$, $\tau_j f$, and $\tau_i \tau_j f$ are co-planar.*

Note that this definition actually belongs to the projective geometry, as it should. To understand what restrictions does this condition impose, we consider various values of M .

M=2: discrete surface parametrized by conjugate lines. Suppose two coordinate lines, $f|_{\mathcal{B}_1}$ and $f|_{\mathcal{B}_2}$, on a Q-surface $f : \mathbb{Z}^2 \rightarrow \mathbb{R}^3$ are given. To extend the surface into the quadrant \mathbb{Z}_+^2 , say, one proceeds by induction whose step consists of choosing f_{12} in the plane spanned by f , f_1 and f_2 , provided the latter three points are known (here we write f_i , f_{ij} for $\tau_i f$, $\tau_i \tau_j f$, etc.). The planarity condition is equivalent to the relation

$$\delta_1 \delta_2 f = c_{21} \delta_1 f + c_{12} \delta_2 f.$$

So, one has two free real parameters c_{21} , c_{12} on each such step. It is convenient to think of these parameters as attached to the elementary square $(u, u + e_1, u + e_1 + e_2, u + e_2)$ of the lattice \mathbb{Z}^2 . Thus, one can define a Q-surface f by prescribing its two coordinate lines $f|_{\mathcal{B}_1}$, $f|_{\mathcal{B}_2}$, and two real-valued functions c_{12}, c_{21} defined on all elementary squares of \mathbb{Z}^2 .

Actually, the combinatorics of Q-surfaces may well be more complicated than that of \mathbb{Z}^2 . Indeed, Definition 2.1 can be literally extended to maps $f : V(\mathcal{D}) \rightarrow \mathbb{R}^N$, where $V(\mathcal{D})$ is the set of vertices of an arbitrary *quad-graph* \mathcal{D} . A quad-graph is a strongly regular cell decomposition of a surface with all quadrilateral faces. We will later need also the notation $E(\mathcal{D})$ and $F(\mathcal{D})$ for the sets of edges, resp. faces, of a quad-graph \mathcal{D} . As we will show, the integrable nature (multi-dimensional consistency) of the Q-nets gives an opportunity to realize \mathcal{D} as a surface in some \mathbb{Z}^M and to work only on this larger (but simpler) definition domain.

M=3: basic 3D system. Suppose that three coordinate surfaces of a three-dimensional Q-net f are given, that is, $f|_{\mathcal{B}_{12}}$, $f|_{\mathcal{B}_{23}}$ and $f|_{\mathcal{B}_{13}}$. Of course, each one of them is a Q-surface. To extend the net into the octant \mathbb{Z}_+^3 , one proceeds by induction whose step consists of determining f_{123} , provided f , f_i and f_{ij} are known for all $1 \leq i \neq j \leq 3$. The point f_{123} has to lie in three planes $\tau_i \Pi_{jk}$ ($1 \leq i \leq 3$), where $\tau_i \Pi_{jk}$ is the plane passing through three points (f_i, f_{ij}, f_{ik}) . This condition determines f_{123} uniquely. Indeed, all three planes $\tau_1 \Pi_{23}$, $\tau_2 \Pi_{13}$ and $\tau_3 \Pi_{12}$ belong to the three-dimensional affine space through the point f spanned by the vectors $\delta_i f$ ($1 \leq i \leq 3$), and therefore generically these planes intersect at exactly one point. An elementary construction step of a three-dimensional Q-net out of its three coordinate surfaces, i.e., finding the eighth vertex of an elementary hexahedron out of the known seven vertices, is symbolically represented on Fig. 2.1. This is the picture we have in mind when thinking (and speaking) about three-dimensional systems. Of course, one can also give an analytic formulation of this picture. This is done as follows. The

characteristic property of a Q-net is:

$$\delta_i \delta_j f = c_{ji} \delta_i f + c_{ij} \delta_j f, \quad i \neq j. \quad (2.1)$$

Here, as before, functions c_{ij} , c_{ji} , as well as equation (2.1) itself, are thought of as defined on elementary squares of \mathbb{Z}^3 parallel to the coordinate plane \mathcal{B}_{ij} . Six such equations, attached to six facets of an elementary cube of \mathbb{Z}^3 , form the three-dimensional system encoded on Fig. 2.1. Here the numbers $\{c_{jk}\}$ on the facets adjacent to f are considered as known, while the numbers $\{\tau_i c_{jk}\}$ on the facets adjacent to f_{123} are uniquely defined by the compatibility of eqs. (2.1) on all six facets. In other words, it is required that $\delta_i(\delta_j \delta_k f)$ does not depend on the permutation (i, j, k) of the indices $(1, 2, 3)$. This compatibility condition gives:

$$\delta_i c_{jk} = (\tau_k c_{ij}) c_{jk} + (\tau_k c_{ji}) c_{ik} - (\tau_i c_{jk}) c_{ik}, \quad i \neq j \neq k \neq i. \quad (2.2)$$

Note that equations for c_{jk} split off from equations for f ; they constitute a system of 6 (linear) equations for 6 unknown variables $\tau_i c_{jk}$ in terms of the known ones c_{jk} . The resulting map $\{c_{jk}\} \mapsto \{\tau_i c_{jk}\}$ is birational. Sometimes it is this map that is considered as the fundamental 3D system encoded on Fig. 2.1.

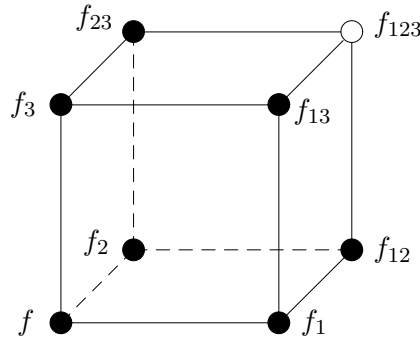

Figure 2.1: 3D system on an elementary cube

$M \geq 4$: consistency. Turning to the case $M \geq 4$, we see that one can prescribe all two-dimensional coordinate surfaces of a Q-net, i.e., $f|_{\mathcal{B}_{ij}}$ for all $1 \leq i < j \leq M$. Indeed, these data are clearly independent, and one can construct the whole net from them. In doing so, one proceeds by induction, again. The inductive step is essentially three-dimensional and consists of determining f_{ijk} , provided f , f_i and f_{ij} are known. However,

this inductive process works, only if one does not encounter contradictions. To see the possible source of contradictions, consider in detail the case of $M = 4$; higher dimensions do not add anything new. From f , f_i and f_{ij} one determines all f_{ijk} uniquely. After that, one has, in principle, four different ways to determine f_{1234} , from four 3-dimensional cubes adjacent to this point; see Fig. 2.2. A remarkable property of Q-nets is that these four values for f_{1234} automatically coincide. We call this property the 4D consistency.

Definition 2.2 *A 3D system is called 4D consistent, if it can be imposed on all three-dimensional facets of an elementary hypercube of \mathbb{Z}^4 .*

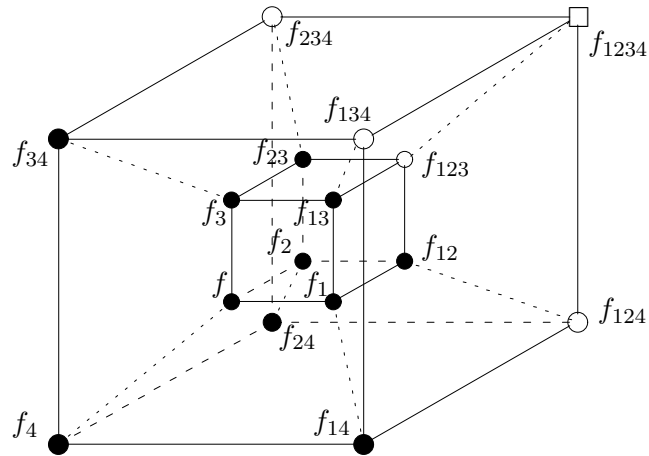

Figure 2.2: 4D consistency of 3D systems

The following fundamental theorem is due to Doliwa and Santini [DoS1].

Theorem 2.3 *The 3D system governing Q-nets is 4D-consistent.*

Proof. Actually, the statement of the theorem is about the properties of the map $\{c_{jk}\} \mapsto \{\tau_i c_{jk}\}$. For such maps with the fields on 2D plaquettes (here each plaquette carries two fields) the 4D consistency means that the two values $\tau_i(\tau_j c_{k\ell})$ and $\tau_j(\tau_i c_{k\ell})$ coincide for any permutation (i, j, k, ℓ) of the indices $(1, 2, 3, 4)$. However, an algebraic proof of this claim could be hardly performed without help of a computer system for symbolic computations. A geometric approach, dealing with this system augmented by the fields

$f \in \mathbb{R}^N$ on the vertices, allows us to perform a conceptual proof, free of computations. Indeed, the map $\{c_{jk}\} \mapsto \{\tau_i c_{jk}\}$ does not depend on the dimension N of the space where f lies. Therefore, we are free to assume that $N \geq 4$. This will enable us to use geometric “general position” arguments.

In the construction above, the four values in question are

$$f_{1234} = \tau_1 \tau_2 \Pi_{34} \cap \tau_1 \tau_3 \Pi_{24} \cap \tau_1 \tau_4 \Pi_{23},$$

and three other ones obtained by cyclic shifts of indices. In general position, the affine space Π_{1234} through f spanned by $\delta_i f$ ($1 \leq i \leq 4$), is four-dimensional. We prove that all six planes $\tau_i \tau_j \Pi_{kl}$ in this four-dimensional space intersect generically at exactly one point (which will be then f_{1234}). It is easy to understand that the plane $\tau_i \tau_j \Pi_{kl}$ is the intersection of two three-dimensional subspaces $\tau_i \Pi_{jkl}$ and $\tau_j \Pi_{ikl}$. Here, of course, the subspace $\tau_i \Pi_{jkl}$ is the one through the four points $(f_i, f_{ij}, f_{ik}, f_{il})$, or, equivalently, the one through f_i spanned by $\delta_j f_i$, $\delta_k f_i$ and $\delta_l f_i$. Now the intersection in question can be alternatively described as the intersection of the four three-dimensional subspaces $\tau_1 \Pi_{234}$, $\tau_2 \Pi_{134}$, $\tau_3 \Pi_{124}$ and $\tau_4 \Pi_{123}$ of one and the same four-dimensional space Π_{1234} . This intersection consists in the generic case of exactly one point. \square

The M -dimensional consistency for $M > 4$ is defined and proved analogously. Actually, it follows from the 4-dimensional consistency.

On the level of formulas we have for $M \geq 4$ the system (2.1), (2.2), where now all indices i, j, k vary between 1 and M . This system consists of interrelated three-dimensional building blocks: for any triple of pairwise different indices (i, j, k) the equations involving these indices only form a closed subset. The M -dimensional consistency of this system means that all three-dimensional building blocks can be imposed without contradictions. A set of initial data which determines a solution of the system (2.1), (2.2), consists of

(Q₁^Δ) values of f on the coordinate axes \mathcal{B}_i for $1 \leq i \leq M$;

(Q₂^Δ) values of c_{ij} , c_{ji} on all elementary squares of the coordinate plane \mathcal{B}_{ij} , for $1 \leq i < j \leq M$.

Quadratic reduction of Q-nets. An important observation made by Doliwa [Do2] is that quadrilateral nets can be consistently restricted to an arbitrary quadric in \mathbb{R}^N . The importance of this resides on the fact that many of the geometrically relevant nets turn out to be reductions of quadrilateral nets to some quadrics or to intersections of quadrics. The quadratic reduction is based on the following fundamental claim:

Theorem 2.4 *If seven points f , f_i and f_{ij} ($1 \leq i < j \leq 3$) of an elementary hexahedron of a quadrilateral net belong to a quadric $\mathbb{Q} \subset \mathbb{R}^N$, then so does the eighth point f_{123} .*

Proof. A deep reason for this is the fact, well known in the projective geometry of the 19-th century: for seven points of a three-dimensional projective space in a general position, one can find the eighth *associated point* which belongs to any quadric through the original seven points (these quadrics form a two-parameter linear family, which contains \mathbb{Q}). Under conditions of Theorem 2.4, we have three (degenerate) quadrics through the original seven points: the pairs of planes $\Pi_{jk} \cup \tau_i \Pi_{jk}$ for $i = 1, 2, 3$. Clearly, their eighth intersection point is $f_{123} = \tau_1 \Pi_{23} \cap \tau_2 \Pi_{31} \cap \tau_3 \Pi_{12}$, and this has to be the associated point. \square

Corollary. *If the coordinate surfaces $f|_{\mathcal{B}_{i_j}}$ of a Q-net $f : \mathbb{Z}^M \rightarrow \mathbb{R}^N$ lie in a quadric \mathbb{Q} , then so does the whole of f .*

Alternative analytic description of Q-nets. In a complete analogy with the smooth case, one can give a (non-local) description of discrete conjugate nets, with somewhat simpler equations. Given the plaquette functions c_{ij} , define quantities h_j , attached to the edges parallel to the j -th coordinate axes, as solutions of the system of difference equations

$$\delta_i h_j = c_{ij} h_j, \quad i \neq j, \quad (2.3)$$

whose compatibility is assured by eq. (2.2). Introduce vectors $v_j = h_j^{-1} \delta_j f$, attached to the same edges. There follows from (2.1) and (2.3) that these vectors satisfy the following difference equations:

$$\delta_i v_j = \frac{h_i}{\tau_i h_j} c_{ji} v_i, \quad i \neq j. \quad (2.4)$$

Define the *discrete rotation coefficients* (attached to plaquettes) as

$$\beta_{ji} = \frac{h_i}{\tau_i h_j} c_{ji}. \quad (2.5)$$

Then we end up with the following system:

$$\delta_i f = h_i v_i, \quad (2.6)$$

$$\delta_i v_j = \beta_{ji} v_i, \quad i \neq j, \quad (2.7)$$

$$\delta_i h_j = (\tau_j h_i) \beta_{ij}, \quad i \neq j. \quad (2.8)$$

Rotation coefficients satisfy a closed system of difference equations (*discrete Darboux system*), which follows from eqs. (2.2) upon substitution (2.5), or otherwise can be derived as compatibility conditions of the linear difference equations (2.7):

$$\delta_i \beta_{kj} = (\tau_j \beta_{ki}) \beta_{ij}, \quad i \neq j \neq k \neq i. \quad (2.9)$$

This system, which is considerably simpler than (2.2), was first derived in [BogK] without any relation to geometry. A geometric interpretation in terms of Q-nets was found in [DoS1]. It should be mentioned that eqs. (2.8) and (2.9) are implicit, but can be easily solved for the shifted variables, resulting in

$$\tau_i h_j = \frac{h_j + h_i \beta_{ij}}{1 - \beta_{ij} \beta_{ji}}, \quad i \neq j, \quad (2.10)$$

$$\tau_i \beta_{kj} = \frac{\beta_{kj} + \beta_{ki} \beta_{ij}}{1 - \beta_{ij} \beta_{ji}}, \quad i \neq j \neq k \neq i. \quad (2.11)$$

The last formula defines an explicit rational 3D map $\{\beta_{kj}\} \mapsto \{\tau_i \beta_{kj}\}$. Like the map $\{c_{kj}\} \mapsto \{\tau_i c_{kj}\}$ for the local plaquette coefficients, the map (2.11) is 4D-consistent, but now this can be checked by an easy computation “by hands”.

Transformations of Q-nets. A natural generalization of Definition 1.2 would be the following one.

Definition 2.5 *A pair of m -dimensional Q-nets $f, f^+ : \mathbb{Z}^m \rightarrow \mathbb{R}^N$ is called a Jonas pair, if four points $f, \tau_i f, f^+$ and $\tau_i f^+$ are co-planar at any point $u \in \mathbb{Z}^m$ and for any $1 \leq i \leq m$. The net f^+ is called a Jonas transform of the net f .*

But actually this relation can be re-phrased as follows: set $F(u, 0) = f(u)$ and $F(u, 1) = f^+(u)$, then $F : \mathbb{Z}^m \times \{0, 1\} \rightarrow \mathbb{R}^N$ is an M -dimensional Q-net, where $M = m + 1$. Thus, in the discrete case there is no difference between conjugate nets and their Jonas transformations. The situation of Definition 2.5 is governed by the equation

$$\delta_i f^+ = a_i \delta_i f + b_i (f^+ - f), \quad (2.12)$$

where coefficients a_i, b_i are nothing but $a_i = 1 + c_{Mi}$, $b_i = c_{iM}$. These coefficients are naturally attached to elementary squares of \mathbb{Z}^M parallel to the coordinate plane \mathcal{B}_{iM} . It is also convenient to think of them as attached to edges of \mathbb{Z}^m parallel to \mathcal{B}_i (to which the corresponding “vertical” squares

are adjacent). Equations of the system (2.2) with one of the indices equal to M give:

$$\delta_i a_j = (\tau_j b_i)(a_j - 1) + (\tau_j a_i - \tau_i a_j) c_{ij}, \quad (2.13)$$

$$\delta_i b_j = c_{ij}^+ b_j + c_{ji}^+ b_i - (\tau_i b_j) b_i, \quad (2.14)$$

$$a_j c_{ij}^+ = (\tau_j a_i) c_{ij} + (\tau_j b_i)(a_j - 1). \quad (2.15)$$

Following data are needed to specify a Jonas transform f^+ of a given m -dimensional Q-net f :

(J_1^Δ) value of $f^+(0)$;

(J_2^Δ) values of a_i, b_i on all edges of the respective coordinate axis \mathcal{B}_i , for $1 \leq i \leq m$.

Alternative description of discrete Jonas transformations. We give here a discrete version of the Eisehart's formulation of the Jonas transformation. One derives from eqs. (2.13)–(2.15) the following formulas:

$$\left(1 + \tau_i \left(\frac{b_j}{a_j}\right)\right) \left(1 + \frac{b_i}{a_i}\right) = 1 + (1 + c_{ij}) \frac{b_j}{a_j} + (1 + c_{ji}) \frac{b_i}{a_i}, \quad (2.16)$$

$$\left(1 + \tau_i b_j\right) \left(1 + b_i\right) = 1 + (1 + c_{ij}^+) b_j + (1 + c_{ji}^+) b_i. \quad (2.17)$$

The symmetry of their right-hand sides implies that there exist functions $\phi, \phi^+ : \mathbb{Z}^m \rightarrow \mathbb{R}$ (associated to points of \mathbb{Z}^m) such that

$$\frac{\tau_i \phi}{\phi} = 1 + \frac{b_i}{a_i}, \quad \frac{\tau_i \phi^+}{\phi^+} = 1 + b_i, \quad 1 \leq i \leq m. \quad (2.18)$$

These functions are defined uniquely up to constant factors, which can be fixed by requiring $\phi(0) = \phi^+(0) = 1$. Moreover, eqs. (2.16), (2.17) imply that the functions ϕ, ϕ^+ satisfy the following equations:

$$\delta_i \delta_j \phi = c_{ij} \delta_j \phi + c_{ji} \delta_i \phi, \quad (2.19)$$

$$\delta_i \delta_j \phi^+ = c_{ij}^+ \delta_j \phi^+ + c_{ji}^+ \delta_i \phi^+, \quad (2.20)$$

for all $1 \leq i \neq j \leq m$. Thus, like in the smooth case, a discrete Jonas transformation yields additional scalar solutions ϕ and ϕ^+ of the equations describing the nets f and f^+ , respectively. The solution ϕ is directly specified by the initial data (J_2^Δ). Introduce the functions $g : \mathbb{Z}^m \rightarrow \mathbb{R}^N$ and

$\psi : \mathbb{Z}^m \rightarrow \mathbb{R}$ by the formulas (1.19), so that also the classical representation (1.14) remains valid. A direct computation based on eqs. (2.12), (2.13)–(2.15), and (2.18) shows that the following equations hold:

$$\delta_i g = \alpha_i \delta_i f, \quad (2.21)$$

$$\delta_i \psi = \alpha_i \delta_i \phi, \quad (2.22)$$

where

$$\alpha_i = \frac{a_i - 1}{\tau_i \phi^+}. \quad (2.23)$$

Next, one checks that the quantities α_i satisfy the equations

$$\delta_i \alpha_j = c_{ij} (\tau_j \alpha_i - \tau_i \alpha_j). \quad (2.24)$$

The same argument as in the smooth case shows that the data (J_2^Δ) yield the values of ϕ^+ , and thus the values of α_i , on the coordinate axes \mathcal{B}_i . This uniquely specifies the solutions α_i of the compatible linear system (2.24), which, in turn, allows for a unique determination of the solutions g , ψ of eqs. (2.21), (2.22) with the initial data $g(0) = f^+(0) - f(0)$ and $\psi(0) = 1$.

Continuous limit. Observe that eqs. (2.1), (2.2) are quite similar to eqs. (1.1), (1.2) characterizing smooth conjugate nets. We will demonstrate in Sect. 3 that the status of this similarity can be raised to that of a mathematical theorem about approximation of smooth conjugate nets by discrete ones. More precisely, we will show how to choose initial data for a discrete system (with $M = m$ and a small mesh size ϵ) so that it approximates a given m -dimensional smooth conjugate net as $\epsilon \rightarrow 0$.

Analogously, eqs. (2.12)–(2.15) are similar to eqs. (1.10)–(1.13). Accordingly, initial data of a discrete system with $M = m + 1$ can be chosen so that, keeping one direction discrete, one arrives in the limit at a given smooth conjugate net and its Jonas transform.

For $M = m + 2$ and $M = m + 3$, keeping the last two, resp. three directions discrete, one proves the permutability properties of Jonas transformations formulated in Theorem 1.3. Thus, permutability of Jonas transformations, which is a non-trivial theorem of differential geometry, becomes an obvious consequence of the multidimensional consistency of discrete conjugate nets, combined with the convergence result mentioned above.

2.2 Discrete orthogonal nets

Two-dimensional circular nets ($M = 2$) were introduced in [MPS, Nu] as discrete analogs of the curvature lines parametrized surfaces. A discretization of triply orthogonal coordinate systems ($M = 3$, $N = 3$) was

first proposed in [Bob]. The next crucial step was done in [CDS], where discrete orthogonal nets were generalized to arbitrary dimensions by considering them as a reduction of Q-nets. For further developments, see [DoMS, KoSch, AkhKV, DoS2, BobHe].

Definition 2.6 *A map $f : \mathbb{Z}^M \rightarrow \mathbb{R}^N$ is called an M -dimensional discrete O-net (discrete orthogonal net, or circular net) in \mathbb{R}^N , if any of its elementary quadrilaterals is circular, i.e., if at any $u \in \mathbb{Z}^M$ and for all pairs $1 \leq i \neq j \leq M$ the four points f , $\tau_i f$, $\tau_j f$ and $\tau_i \tau_j f$ are concircular.*

It is important to observe the Möbius invariance of Definition 2.6. To understand restrictions imposed on Q-nets by the circularity condition, we consider again various values of M .

$M=2$: discrete surfaces parametrized along curvature lines.

Suppose two coordinate lines $f|_{\mathcal{B}_1}$ and $f|_{\mathcal{B}_2}$ on a discrete O-surface f are given. An elementary inductive step for extending the O-surface to the quadrant \mathbb{Z}_+^2 , consists of choosing f_{12} on the circle through f , f_1 and f_2 . In doing so, one has the freedom of choosing one real parameter at each such step, for instance, the cross-ratio of four points $q_{12} = q(f, f_1, f_{12}, f_2)$, which is naturally attached to the elementary square $(u, u + e_1, u + e_1 + e_2, u + e_2)$. Thus, to define a discrete O-surface f , one needs to prescribe the coordinate lines $f|_{\mathcal{B}_1}$ and $f|_{\mathcal{B}_2}$ and one real-valued function q_{12} defined on elementary squares.

However, it turns out to be technically more convenient to use other functions on elementary squares of \mathbb{Z}^2 characterizing the form of circular quadrilaterals, namely, *discrete rotation coefficients*. Introduce discrete metric coefficients $h_i = |\delta_i f|$ and unit vectors $v_i = h_i^{-1} \delta_i f$, so that

$$\tau_i f = f + h_i v_i. \quad (2.25)$$

Then the rotation coefficients β_{12} and β_{21} are defined by the formula

$$\tau_i v_j = \nu_{ji}^{-1} (v_j + \beta_{ji} v_i), \quad (2.26)$$

which holds due to planarity of the elementary quadrilateral, with ν_{ji} being appropriate normalization coefficients. From (2.25), (2.26) there easily follows a formula for metric coefficients h_j :

$$\tau_i h_j = \nu_{ji}^{-1} (h_j + h_i \beta_{ij}). \quad (2.27)$$

It is natural to assume that the variables v_i, h_i are attached to the edges of \mathbb{Z}^2 parallel to the coordinate axis \mathcal{B}_i , while the rotation coefficients β_{12}, β_{21}

are attached to elementary squares of \mathbb{Z}^2 . Elementary considerations of the geometry of a circular quadrilateral on Fig. 2.3 show that the discrete rotation coefficients are related by

$$\beta_{ij} + \beta_{ji} + 2\langle v_i, v_j \rangle = 0, \tag{2.28}$$

while the normalization coefficients satisfy

$$\nu_{ij}^2 = \nu_{ji}^2 = 1 - \beta_{ij}\beta_{ji}. \tag{2.29}$$

For an embedded quadrilateral there holds $\nu_{ij} = \nu_{ji} > 0$, while for a non-embedded one there holds $\nu_{ij} = -\nu_{ji}$. Thus, formula (2.28) expresses the

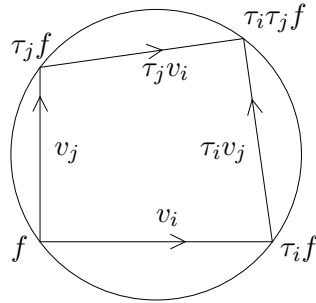

Figure 2.3: An elementary quadrilateral of a discrete orthogonal net

circularity constraint, and reflects the fact that the number of independent plaquette functions necessary to define a discrete O-surface is equal to 1. For instance, it is enough to prescribe β_{12} , or β_{21} , or $\beta_{12} - \beta_{21}$, or any other function of β_{12}, β_{21} , independent on $\beta_{12} + \beta_{21}$.

Equations (2.26), (2.27) give the evolution of the edge variables v_j, h_j , known the plaquette variables β_{12}, β_{21} . Together with eq. (2.25), this allows us to reconstruct a discrete O-surface f , provided the following initial data are given: two coordinate lines $f|_{\mathcal{B}_1}, f|_{\mathcal{B}_2}$ (or, equivalently, the point $f(0)$ and the functions v_i, h_i on the edges of the coordinate axes $\mathcal{B}_i, i = 1, 2$), and the function β_{21} (say) defined on all elementary squares of \mathbb{Z}^2 .

As in the case of Q-surfaces, the combinatorics of discrete O-surfaces may be more complicated than that of \mathbb{Z}^2 , because Definition 2.6 can be literally extended to an arbitrary quad-graph. This possibility is very important from the geometric point of view, since vertices of valence different from 4 serve as a model for umbilic points of a smooth surface parametrized along curvature lines.

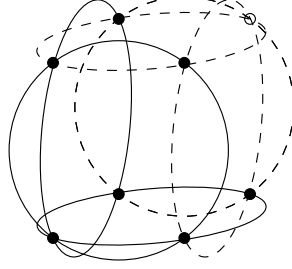

Figure 2.4: An elementary hexahedron of a discrete orthogonal net

$M=3$: basic 3D system. Suppose that three coordinate surfaces of a three-dimensional discrete O-net f are given, that is, $f|_{\mathcal{B}_{12}}$, $f|_{\mathcal{B}_{23}}$ and $f|_{\mathcal{B}_{13}}$. An inductive extension step consists of determining f_{123} , provided f , f_i and f_{ij} are known for all $1 \leq i < j \leq 3$ and satisfy the circular condition on the three corresponding squares. Such a step is possible due to the *Miquel theorem* from the elementary geometry:

Theorem 2.7 *Given three circles C_{ij} and seven points f, f_i, f_{ij} in \mathbb{R}^3 ($1 \leq i < j \leq 3$), such that each quadruple (f, f_i, f_j, f_{ij}) lies on C_{ij} , define three new circles $\tau_i C_{jk}$ as those passing through the triples (f_i, f_{ij}, f_{ik}) , respectively. Then these new circles intersect at one point:*

$$f_{123} = \tau_1 C_{23} \cap \tau_2 C_{31} \cap \tau_3 C_{12}.$$

The claim of the Miquel theorem is equivalent to the following one: if seven points f, f_i, f_{ij} of an elementary hexahedron of a Q-net $f : \mathbb{Z}^3 \rightarrow \mathbb{R}^3$ lie on a two-sphere S^2 , then so does the eighth point f_{123} . To see the equivalence, note that the four points f, f_i determine the sphere S^2 uniquely. Then $f_{ij} \in S^2$ is equivalent to $f_{ij} \in C_{ij} = \Pi_{ij} \cap S^2$. Now, the intersection point of the three circles $\tau_i C_{jk} = \tau_i \Pi_{jk} \cap S^2$ belongs to S^2 and coincides with the unique intersection point of the three planes

$$f_{123} = \tau_1 \Pi_{23} \cap \tau_2 \Pi_{31} \cap \tau_3 \Pi_{12}.$$

This construction is illustrated on Fig. 2.4. Clearly, this is a particular issue of Theorem 2.4. Thus, finding the eighth point of a three-dimensional discrete O-net out of the seven known ones is a 3D system in the sense of Fig. 2.1.

The Miquel theorem guarantees that circularity constraint propagates in the construction of a Q-net from its three coordinate surfaces. This was first observed by Doliwa and Santini [CDS]:

Theorem 2.8 *If three coordinate surfaces $f|_{\mathcal{B}_{12}}$, $f|_{\mathcal{B}_{23}}$, $f|_{\mathcal{B}_{13}}$ of a Q-net $f : \mathbb{Z}^3 \rightarrow \mathbb{R}^3$ are discrete O-surfaces, then the whole of f is a discrete O-net.*

This is a discrete analog of the statement which holds also in the smooth context, and is a sort of inversion of the classical Dupin theorem.

On the level of formulas, for discrete O-nets the system encoded on Fig. 2.1 consists of eqs. (2.25), (2.26), (2.27) for all $1 \leq i \neq j \leq 3$, with the normalization coefficients given in (2.29), which have to be augmented by evolution equations for the rotation coefficients. These latter ones represent the solvability of the system of linear equations (2.26) and are derived from the requirement $\tau_i(\tau_j v_k) = \tau_j(\tau_i v_k)$. Like in the case of Q-nets, these equations are decoupled from the rest ones, and generate a well defined map $\{\beta_{kj}\} \mapsto \{\tau_i \beta_{kj}\}$:

$$\tau_i \beta_{kj} = (\nu_{ki} \nu_{ij})^{-1} (\beta_{kj} + \beta_{ki} \beta_{ij}). \quad (2.30)$$

However, this evolution of the discrete rotation coefficients β_{kj} can be coupled to the evolution (2.26) of the unit vectors v_i by means of the circularity constraint (2.28). It follows from the Miquel theorem, and can be easily checked analytically, that this constraint propagates in the coupled evolution.

$M \geq 4$: consistency. The 4D consistency of discrete O-nets is a consequence of the analogous property of Q-nets, since the O-constraint is compatible with the Q-property.

On the level of formulas we have for $M \geq 4$ the system (2.25), (2.26), (2.27), (2.30), augmented by the circularity constraint (2.28), where now all indices i, j, k vary between 1 and M . For any triple of pairwise different indices (i, j, k) , equations involving these indices solely, form a closed subset. The M -dimensional consistency of this system means that all three-dimensional building blocks can be imposed without contradictions. Initial data which allow for a unique solution of this system consist of:

- (O₁^Δ) values of f on the coordinate axes \mathcal{B}_i (or, what is equivalent, value $f(0)$ and values of v_i and h_i on all edges of the coordinate axes \mathcal{B}_i) for $1 \leq i \leq M$;
- (O₂^Δ) values of $M(M-1)/2$ functions β_{ji} (say) on all elementary squares of the coordinate planes \mathcal{B}_{ij} for $1 \leq i < j \leq M$.

At this point, it will be useful to observe the similarity of eqs. (2.25), (2.26), (2.27), (2.30) and the constraint (2.28) with the system (1.6)–(1.9) and the constraint (1.24) governing smooth orthogonal nets. Like in the case of conjugate nets, we will demonstrate that this analogy can be given a qualitative content, so that smooth O-nets can be approximated by discrete ones. However, there is a substantial obstruction in performing this. We think of smooth rotation coefficients as being approximated by discrete ones. But since the discrete rotation coefficients β_{kj} only have $i \neq k, j$ as evolution directions (that is, they are *plaque* variables attached to elementary squares parallel to \mathcal{B}_{jk}), there is seemingly no chance to get an approximation of such smooth quantities as $\partial_i \beta_{ij}$ involved in the smooth orthogonality constraint (1.24). In order to be able to achieve such an approximation, we need some discrete analogs of the smooth rotation coefficients which would live on *edges*. Such analogs will be introduced with the help of the notion of a frame of a discrete O-net. Technical means for defining and constructing frames are given by the apparatus of Möbius differential geometry.

Transformations of discrete O-nets. A natural generalization of Definition 1.5 would be the following one.

Definition 2.9 *A pair of m -dimensional discrete O-nets $f, f^+ : \mathbb{Z}^m \rightarrow \mathbb{R}^N$ is called a Ribaucour pair, if four points $f, \tau_i f, f^+$ and $\tau_i f^+$ are concircular at any $u \in \mathbb{Z}^m$ and for any $1 \leq i \leq m$. The net f^+ is called a Ribaucour transform of the net f .*

But this simply means that, if we set $F(u, 0) = f(u)$, $F(u, 1) = f^+(u)$, then $F : \mathbb{Z}^m \times \{0, 1\} \rightarrow \mathbb{R}^N$ is an M -dimensional discrete O-net, where $M = m+1$. So, in the discrete case there is no difference between orthogonal nets and their Ribaucour transformations. To specify a Ribaucour transform f^+ of a given m -dimensional discrete O-net f , one clearly needs the following data:

(R_1^Δ) value of $f^+(0)$;

(R_2^Δ) values of β_{Mi} (say) on “vertical” elementary squares attached to all edges of the coordinate axes \mathcal{B}_i for $1 \leq i \leq m$.

Möbius-geometric description of discrete O-nets. Putting discrete O-nets in the Möbius-geometric model \mathbb{Q}_0^N of the Euclidean space \mathbb{R}^N , we observe first of all that Theorem 1.7 admits an almost literal generalization to the discrete case.

Theorem 2.10 *A Q -net $f : \mathbb{Z}^M \rightarrow \mathbb{R}^N$ is a discrete O-net, if and only if $|f|^2$ satisfies the same equation (2.1) as f does, in other words, if the corresponding $\hat{f} : \mathbb{Z}^M \rightarrow \mathbb{Q}_0^N$ is a Q -net in $\mathbb{R}^{N+1,1}$.*

(The first claim here is due to [KoSch].) Thus, in the Möbius-geometric picture discrete O-nets are a quadratic reduction (to \mathbb{Q}_0^N) of Q-nets.

Let \hat{v}_i be the (Lorentz) unit vectors parallel to $\delta_i \hat{f}$. For the discrete metric coefficients $h_i = |\delta_i f|$ there holds also $h_i = |\delta_i \hat{f}|$. One readily verifies that from $\langle \hat{f}, \hat{f} \rangle = 0$ there follows $\langle \tau_i \hat{f} + \hat{f}, \hat{v}_i \rangle = 0$ and $h_i = -2\langle \hat{f}, \hat{v}_i \rangle$. Therefore, \hat{v}_i are interpreted in the Möbius-geometric picture as reflections taking \hat{f} to $\tau_i \hat{f}$:

$$\tau_i \hat{f} = \hat{f} + h_i \hat{v}_i = \hat{v}_i \hat{f} \hat{v}_i. \quad (2.31)$$

Due to Theorem 2.10, vectors \hat{v}_i satisfy the same linear relations (2.26) as v_i , with the same discrete rotations coefficients β_{ji} .

Theorem 2.11 (Spinor frame of a discrete O-net) *For a discrete O-net $f : \mathbb{Z}^M \rightarrow \mathbb{R}^N$ (and the corresponding Q-net $\hat{f} : \mathbb{Z}^M \rightarrow \mathbb{Q}_0^N$), there exists a function $\psi : \mathbb{Z}^M \rightarrow \mathcal{H}_\infty$ (called a frame of \hat{f}) such that*

$$\hat{f} = \psi^{-1} \mathbf{e}_0 \psi, \quad (2.32)$$

satisfying the system of difference equations:

$$\tau_i \psi = -\mathbf{e}_i \psi \hat{v}_i, \quad 1 \leq i \leq M. \quad (2.33)$$

Proof. This theorem is due to [BobHe]. Circularity of an elementary quadrilateral of f implies that the angle between $\delta_i f$ and $\tau_i \delta_j f$ and the angle between $\delta_j f$ and $\tau_j \delta_i f$ sum up to π :

$$\langle \tau_j v_i, v_j \rangle + \langle v_i, \tau_i v_j \rangle = 0. \quad (2.34)$$

The same relation holds for the vectors \hat{v}_i . Moreover, since for these vectors there holds also eq. (2.26) with $\nu_{ij} = \nu_{ji}$, there follows that eq. (2.34) for \hat{v}_i is equivalent to

$$\hat{v}_j(\tau_j \hat{v}_i) + \hat{v}_i(\tau_i \hat{v}_j) = 0. \quad (2.35)$$

But this is exactly the compatibility condition of the system (2.33) of linear difference equations for ψ . Indeed, the solvability condition $\tau_j \tau_i \psi = \tau_i \tau_j \psi$ is written as

$$\mathbf{e}_i \mathbf{e}_j \psi \hat{v}_j(\tau_j \hat{v}_i) = \mathbf{e}_j \mathbf{e}_i \psi \hat{v}_i(\tau_i \hat{v}_j),$$

which is equivalent to (2.35). Thus, a solution to (2.33) exists and is uniquely defined by the choice of $\psi(0) \in \mathcal{H}_\infty$. Choose $\psi(0)$ so that eq. (2.32) holds at $u = 0$. Then eqs. (2.33), (2.31) imply that eq. (2.32) holds everywhere on \mathbb{Z}^M . \square

Now introduce vectors $V_i = \psi \hat{v}_i \psi^{-1}$, so that the frame equations (2.33) take the form $(\tau_i \psi) \psi^{-1} = -\mathbf{e}_i V_i$. Expanding these vectors with respect to the basis vectors \mathbf{e}_k , we have a formula analogous to (1.34):

$$V_i = \psi \hat{v}_i \psi^{-1} = \sigma_i \mathbf{e}_i - \frac{1}{2} \sum_{k \neq i} \rho_{ki} \mathbf{e}_k + h_i \mathbf{e}_\infty. \quad (2.36)$$

The fact that the \mathbf{e}_∞ -component here is equal to h_i , is easily demonstrated. Indeed, from eq. (2.33) there follows that $\tau_i \hat{f} - \hat{f} = h_i \hat{v}_i = h_i (\tau_i \psi)^{-1} \mathbf{e}_i \psi$. Now eq. (2.32) allows us to rewrite this equivalently as $[\mathbf{e}_0, (\tau_i \psi) \psi^{-1}] = h_i \mathbf{e}_i$, which proves the claim above. Observe also the normalization condition

$$\sigma_i^2 = 1 - \frac{1}{4} \sum_{k \neq i} \rho_{ki}^2. \quad (2.37)$$

Coefficients ρ_{ki} are *edge variables* analogous to smooth rotation coefficients. Indeed, vectors V_i are defined on edges of \mathbb{Z}^M parallel to the coordinate axis \mathcal{B}_i , but they do not immediately reflect the local geometry near these edges. Rather, they are obtained by integration of the frame equations (2.33), and thus are of a *non-local* nature. Thus, in the discrete case we have two different analogs of the rotation coefficients: local plaquette variables β_{ij} for $1 \leq i \neq j \leq M$, defined on elementary squares of \mathbb{Z}^M parallel to \mathcal{B}_{ij} , and non-local edge variables ρ_{ki} for $1 \leq i \leq M$, $1 \leq k \leq N$, $k \neq i$, defined on edges of \mathbb{Z}^M parallel to \mathcal{B}_i .

Evolution equations for V_i are obtained from (2.26) and the frame equations (2.33):

$$\tau_i V_j = \nu_{ji}^{-1} \mathbf{e}_i (V_j + \beta_{ij} V_i) \mathbf{e}_i.$$

In the derivation one uses the identity $\hat{v}_i (\hat{v}_j + \beta_{ji} \hat{v}_i) \hat{v}_i = \hat{v}_j + \beta_{ij} \hat{v}_i$, which follows easily from (2.28). The resulting evolution equations for the edge variables ρ_{kj} read:

$$\tau_i \rho_{kj} = \nu_{ji}^{-1} (\rho_{kj} + \rho_{ki} \beta_{ij}), \quad (2.38)$$

$$\tau_i \rho_{ij} = \nu_{ji}^{-1} (-\rho_{ij} + 2\sigma_i \beta_{ij}). \quad (2.39)$$

Here $1 \leq i \neq j \leq M$, $1 \leq k \leq N$, and $k \neq i, j$. The circularity constraint (2.28) can be now written as

$$\beta_{ij} + \beta_{ji} = \sigma_i \rho_{ij} + \sigma_j \rho_{ji} - \frac{1}{2} \sum_{k \neq i, j} \rho_{ki} \rho_{kj}, \quad (2.40)$$

and gives a relation between local plaquette variables β_{ij} and non-local edge variables ρ_{kj} . The system consisting of (2.38), (2.39) and (2.40) can be regarded as the *discrete Lamé system*.

Continuous limit. In Sect. 3.4 we will show how to choose these data on the lattice with mesh size ϵ in m directions and mesh size 1 in the M -th direction, in order to achieve a simultaneous approximation of a smooth orthogonal net and its Ribaucour transformation. Performing a smooth limit so that two or three of the directions remain discrete, one can derive the permutability properties of Ribaucour transformations formulated in Theorem 1.6. This way, permutability of Ribaucour transformations becomes a simple consequence of properties of discrete orthogonal nets, combined with the convergence result mentioned above.

2.3 Discrete Moutard nets

Discrete Moutard nets were introduced in [NiSch].

Definition 2.12 *A map $f : \mathbb{Z}^2 \rightarrow \mathbb{R}^N$ is called a two-dimensional discrete M-net, if it satisfies the discrete Moutard equation*

$$\tau_1 \tau_2 f + f = a_{12}(\tau_1 f + \tau_2 f) \quad (2.41)$$

with some $a_{12} : \mathbb{Z}^2 \rightarrow \mathbb{R}$.

Initial data that can be used to determine a discrete M-net are:

(M₁^Δ) values of f on the coordinate axes $\mathcal{B}_1, \mathcal{B}_2$;

(M₂^Δ) function a_{12} defined on elementary squares of \mathbb{Z}^2 .

Like in the smooth case, discrete M-nets are not Q-nets, and there are no M -dimensional discrete M-nets with $M \geq 3$. There is a construction, analogous to the smooth case, relating discrete M-nets to a special class of Q-nets. Let $\nu : \mathbb{Z}^2 \rightarrow \mathbb{R}$ be any solution of the same discrete Moutard equation (2.41) (for instance, any component of the vector f), then $y = \nu^{-1} f : \mathbb{Z}^2 \rightarrow \mathbb{R}^N$ is a Q-net:

$$y_{12} - y = \frac{\nu_1(\nu_{12} + \nu)}{\nu_{12}(\nu_1 + \nu_2)}(y_1 - y) + \frac{\nu_2(\nu_{12} + \nu)}{\nu_{12}(\nu_1 + \nu_2)}(y_2 - y).$$

However, there exists a relation to discrete conjugate nets of a quite different flavor, which is of a purely discrete nature and has no smooth analogs. To describe it, perform in (2.43) the change of variables

$$f(u) \mapsto (-1)^{u_2} f(u), \quad u = (u_1, u_2) \in \mathbb{Z}^2. \quad (2.42)$$

Then the new function f satisfies the following modified form of the discrete Moutard equation:

$$\tau_1\tau_2f - f = a_{12}(\tau_2f - \tau_1f).$$

This equation admits a multidimensional generalization:

Definition 2.13 *A map $f : \mathbb{Z}^M \rightarrow \mathbb{R}^N$ is called an M -dimensional T-net (trapezoidal net), if for any $u \in \mathbb{Z}^M$ and for any pair of indices $i \neq j$ there holds the discrete Moutard equation*

$$\tau_i\tau_jf - f = a_{ij}(\tau_jf - \tau_if), \quad (2.43)$$

with some $a_{ij} : \mathbb{Z}^M \rightarrow \mathbb{R}$, in other words, if all the elementary quadrilaterals $(f, \tau_if, \tau_i\tau_jf, \tau_jf)$ are planar and have parallel diagonals.

Of course, coefficients a_{ij} have to be skew-symmetric, $a_{ij} = -a_{ji}$. As usual, we will consider these functions as attached to elementary squares of \mathbb{Z}^M .

T-nets, unlike discrete M-nets, form a subclass of Q-nets. The condition of parallel diagonals is expressed as $c_{ij} + c_{ji} + 2 = 0$ for the coefficients c_{ij} of a Q-net, the skew-symmetric coefficients of the T-net being $a_{ij} = c_{ij} + 1$.

M=2: T-surfaces. To define a two-dimensional T-net $f : \mathbb{Z}^2 \rightarrow \mathbb{R}^N$, one can prescribe two coordinate curves, $f|_{\mathcal{B}_1}$ and $f|_{\mathcal{B}_2}$, and a real-valued function a_{12} on elementary squares of \mathbb{Z}^2 .

M=3: basic 3D system. We show that three-dimensional T-nets are described by a well-defined three-dimensional system. An inductive construction step of the net f is as follows. Suppose that f , f_i and f_{ij} are given for all $1 \leq i \neq j \leq 3$, satisfying eq. (2.43). Three equations (2.43) for the facets of an elementary cube on Fig. 2.1 adjacent to f_{123} , lead to consistent results for f_{123} for arbitrary initial data, if and only if the following conditions are satisfied:

$$(\tau_ia_{jk})a_{ij} + (\tau_ja_{ki})(a_{jk} + a_{ij}) = -1,$$

where (i, j, k) is an arbitrary permutation of $(1, 2, 3)$. These conditions constitute a system of 6 (linear) equations for 3 unknown variables τ_ia_{jk} in terms of the known ones a_{jk} . It turns out that this system is not overdetermined but admits a unique solution:

$$\frac{\tau_ia_{jk}}{a_{jk}} = -\frac{1}{a_{ij}a_{jk} + a_{jk}a_{ki} + a_{ki}a_{ij}}, \quad (2.44)$$

With τ_ia_{jk} so defined, eqs. (2.43) are fulfilled on all three quadrilaterals adjacent to f_{123} .

Eqs. (2.44) represent a well-defined birational map $\{a_{jk}\} \mapsto \{\tau_i a_{jk}\}$, which can be considered as the fundamental 3D system related to T-nets. It is sometimes called the “star-triangle map”. Moreover, this system is a reduction of the system describing Q-nets:

Theorem 2.14 *If three coordinate surfaces $f|_{\mathcal{B}_{12}}, f|_{\mathcal{B}_{23}}, f|_{\mathcal{B}_{13}}$ of a Q-net $f : \mathbb{Z}^3 \rightarrow \mathbb{R}^N$ are T-nets, then f is a T-net.*

Proof. Let three quadrilaterals (f, f_i, f_{ij}, f_j) be planar and have parallel diagonals. The planarity of the three quadrilaterals $(f_i, f_{ij}, f_{ijk}, f_{ik})$ defines the point f_{123} as the intersection point of three planes $\tau_i \Pi_{jk}$. Then these three quadrilaterals automatically have parallel diagonals. Indeed, by the above argument, there exists a point f_{123} with this property, and it has to coincide with the one defined by the planarity condition. \square

$M \geq 4$: consistency. The 4D consistency of T-nets is a consequence of the analogous property of Q-nets, since T-constraint is compatible with the Q-property. On the level of formulas we have for T-nets with $M \geq 4$ the system (2.43), (2.44). All indices i, j, k vary now between 1 and M , and for any triple of pairwise different indices (i, j, k) , equations involving these indices solely, form a closed subset. Initial data which allow for a unique solution of this system consist of values of f on the coordinate axes \mathcal{B}_i for $1 \leq i \leq M$, and values of $M(M-1)/2$ functions a_{ij} on all elementary squares of the coordinate planes \mathcal{B}_{ij} for $1 \leq i < j \leq M$.

Transformations of discrete M- and T-nets. Because of the multi-dimensional consistency, transformations of T-nets do not differ from the nets themselves, and are described by the discrete Moutard equations. We would like, however, to consider transformations of discrete M-nets, which have geometric applications. For this, we consider a three-dimensional T-net $F : \mathbb{Z}^2 \times \{0, 1\}$, perform the change of variables

$$F(u) \mapsto (-1)^{u_2} F(u), \quad u = (u_1, u_2, u_3),$$

and then set $f = F(\cdot, 0)$, $f^+ = F(\cdot, 1)$. Eqs. (2.43) for $(i, j) = (1, 2)$ turn into (2.41), so that f, f^+ are discrete M-nets, while for $(i, j) = (1, 3)$ and $(2, 3)$ eqs. (2.43) turn into

$$\tau_1 f^+ - f = b_1(f^+ - \tau_1 f), \quad \tau_2 f^+ + f = b_2(f^+ + \tau_2 f), \quad (2.45)$$

where $b_1 = a_{13}$, $b_2 = a_{32}$. The quantities b_i , defined on the “vertical” plaquettes of $\mathbb{Z}^2 \times \{0, 1\}$, parallel to \mathcal{B}_{i3} , can be also associated to the edges

of \mathbb{Z}^2 parallel to the coordinate axes \mathcal{B}_i . Eqs. (2.44) with one of the indices equal to 3 express compatibility of eqs. (2.45) with eq. (2.43):

$$\frac{\tau_2 b_1}{b_1} = \frac{\tau_1 b_2}{b_2} = \frac{a_{12}^+}{a_{12}} = \frac{1}{(b_1 + b_2)a_{12} - b_1 b_2}. \quad (2.46)$$

Eqs. (2.45), (2.46) define a *discrete Moutard transformation* of f . To specify a Moutard transform f^+ of a given discrete M-net f , one can prescribe the following data:

(MT₁^Δ) value of $f^+(0)$;

(MT₂^Δ) values of b_i on “vertical” elementary squares attached to all edges of the coordinate axes \mathcal{B}_i for $i = 1, 2$.

The permutability properties of Moutard transformations are governed by the discrete Moutard equations (2.43) with $i, j \geq 3$.

Due to the first equation in (2.46), there exists a function $\theta : \mathbb{Z}^2 \rightarrow \mathbb{R}$ (associated to the points of \mathbb{Z}^2) such that

$$b_i = \frac{\theta}{\tau_i \theta}, \quad i = 1, 2. \quad (2.47)$$

The last equation in (2.46) implies that this function is a scalar solution of the discrete Moutard equation (2.41). This solution is specified by its values on the coordinate axes \mathcal{B}_i , which are immediately obtained, via eq. (2.47), from the data (MT₂^Δ). Recall that f^+ is a solution of the discrete Moutard equation (2.41) with the transformed potential a_{12}^+ . The second equation in (2.46) gives a representation of a_{12}^+ in terms of θ :

$$a_{12}^+ = a_{12} \frac{(\tau_1 \theta)(\tau_2 \theta)}{\theta(\tau_1 \tau_2 \theta)} = \frac{\tau_1 \tau_2 \theta^+ + \theta^+}{\tau_1 \theta^+ + \tau_2 \theta^+}, \quad \theta^+ = \frac{1}{\theta}. \quad (2.48)$$

This is a discrete analog of the classical formulation of the Moutard transformation.

2.4 Discrete asymptotic nets

The following definition is due to Sauer [Sa] for $M = 2$, when it describes a discrete analog of surfaces parametrized along asymptotic lines (A-surfaces). For $M \geq 3$, see [Do4, DoNS1, Nie].

Definition 2.15 A map $f : \mathbb{Z}^M \rightarrow \mathbb{R}^3$ is called an M -dimensional discrete A-net (discrete asymptotic net) in \mathbb{R}^3 , if for any $u \in \mathbb{Z}^M$ all the points $f(u \pm e_i)$ lie in some plane $\mathcal{P}(u)$ through $f(u)$.

Note that this definition belongs to the projective geometry. For $M = 3$, the geometry of an elementary hexahedron of a discrete A-net is exactly that of a *Möbius pair of tetrahedra*, i.e., a pair of tetrahedra which are inscribed in each other. In other words, each vertex of each tetrahedron lies in the plane of the corresponding facet of the other one (eight conditions). In our case the two tetrahedra are those with the vertices $(f, f_{12}, f_{23}, f_{31})$ and with the vertices (f_1, f_2, f_3, f_{123}) . Such pairs were introduced by Möbius [Mö], who demonstrated that eight conditions mentioned above are not independent: any one of them follows from the remaining seven. Möbius pairs are remarkable and well-studied objects of the projective geometry, cf. [Bob].

For a non-degenerate discrete A-net, all quadrilaterals $(f, \tau_i f, \tau_i \tau_j f, \tau_j f)$ are non-planar. It would be in principle possible to consider discrete A-nets in \mathbb{R}^N with $N > 3$, however it would not lead to an essential generalization. Indeed, for any fixed $u \in \mathbb{Z}^M$ and for any pair of indices $i \neq j$ from $\{1, \dots, M\}$, consider the three-dimensional affine subspace of \mathbb{R}^N through $f = f(u)$ which contains $\tau_i f$, $\tau_j f$ and $\tau_i \tau_j f$. A simple induction shows that the whole net f lies in this subspace.

For a discrete A-net $f : \mathbb{Z}^M \rightarrow \mathbb{R}^3$ we have a field of tangent planes $\mathcal{P} : \mathbb{Z}^M \rightarrow \text{Gr}_2(3)$, and therefore a well-defined *normal direction* at every point of \mathbb{Z}^M . A remarkable way to fix a certain normal field is given by the *discrete Lelievre representation* [KoP] which states:

Theorem 2.16 For a non-degenerate discrete A-net f , there exists a normal field $n : \mathbb{Z}^M \rightarrow \mathbb{R}^3$ such that

$$\delta_i f = \tau_i n \times n, \quad i = 1, \dots, M, \quad (2.49)$$

called a Lelievre normal field. It is uniquely defined by a value at one point $u_0 \in \mathbb{Z}^M$. All other Lelievre normal fields are obtained by $n(u) \mapsto \alpha n(u)$ for $|u| = u_1 + \dots + u_M$ even, and $n(u) \mapsto \alpha^{-1} n(u)$ for $|u|$ odd, with some $\alpha \in \mathbb{R}$ (black-white rescaling).

It follows from eq. (2.49) immediately that $(\tau_i \tau_j n - n) \times (\tau_i n - \tau_j n) = 0$, that is, the Lelievre normal field satisfies the discrete Moutard equations

$$\tau_i \tau_j n - n = a_{ij} (\tau_j n - \tau_i n) \quad (2.50)$$

with some $a_{ij} : \mathbb{Z}^M \rightarrow \mathbb{R}$. Conversely, given a T-net $n : \mathbb{Z}^M \rightarrow \mathbb{R}^3$, formula (2.49) produces a discrete A-net $f : \mathbb{Z}^M \rightarrow \mathbb{R}^3$.

Theorem 2.17 *Discrete A-nets in \mathbb{R}^3 are in a one-to-one correspondence, via the discrete Lelievre representation (2.49), with T-nets in \mathbb{R}^3 .*

In particular, the initial data which determine a discrete A-net are analogous to the data $(M_{1,2}^\Delta)$ for the Lelievre normal field:

(A_1^Δ) values of n on the coordinate axes \mathcal{B}_i for $1 \leq i \leq M$;

(A_2^Δ) values of $M(M-1)/2$ functions a_{ij} on all elementary squares of the coordinate planes \mathcal{B}_{ij} for $1 \leq i < j \leq M$.

Transformations of discrete A-nets. A natural generalization of Definition 1.5 would be the following one.

Definition 2.18 *A pair of discrete A-nets $f, f^+ : \mathbb{Z}^m \rightarrow \mathbb{R}^3$ is called a Weingarten pair, if, for any $u \in \mathbb{Z}^m$, the line segment $[f(u), f^+(u)]$ lies in both tangent planes to f and f^+ at the points $f(u)$ and $f^+(u)$, respectively. The net f^+ is called a Weingarten transform of the net f .*

But, as usual, this definition means simply that the net $F : \mathbb{Z}^m \times \{0, 1\} \rightarrow \mathbb{R}^3$ with $F(u, 0) = f(u)$ and $F(u, 1) = f^+(u)$ is an M -dimensional discrete A-net, where $M = m + 1$. So, once again, transformations of discrete A-nets do not differ from the nets themselves. The Lelievre representation of the net F can be written now as a relation between the Lelievre representations of the nets f, f^+ :

$$f^+ - f = n^+ \times n. \quad (2.51)$$

Definition 2.18 makes sense for an arbitrary M ; however, we will be mainly interested in the case $M = 2$, which is an immediate discretization of the smooth A-surfaces. The change of variables (2.42) for the Lelievre normal field,

$$n(u) \mapsto (-1)^{u_2} n(u), \quad u = (u_1, u_2) \in \mathbb{Z}^2, \quad (2.52)$$

leads to a replacement of the general Lelievre formulas (2.49) by

$$\delta_1 f = \tau_1 n \times n = \delta_1 n \times n, \quad \delta_2 f = n \times \tau_2 n = n \times \delta_2 n. \quad (2.53)$$

For a Moutard transformation of the Lelievre normal field there hold formulas (2.45):

$$\tau_1 n^+ - n = b_1(n^+ - \tau_1 n), \quad \tau_2 n^+ + n = b_2(n^+ + \tau_2 n). \quad (2.54)$$

Thus, a Weingarten transform f^+ of a given discrete A-net f is determined by a Moutard transform n^+ of the Lelievre normal field n , and in order to specify the latter, one can prescribe the following data:

(W_1^Δ) value of $n^+(0)$;

(W_2^Δ) values of b_i on “vertical” elementary squares attached to all edges of the coordinate axes \mathcal{B}_i for $i = 1, 2$.

Permutability of discrete Weingarten transformations is a direct consequence of the 4D consistency of T-nets. Permutability of smooth Weingarten transformations (Theorem 1.16) will follow, if one combines the discrete permutability with the convergence results of Sect. 3.6.

2.5 Discrete K-nets

In discretizing the K-surfaces and their transformations, we take as a starting point the characterization of Theorem 1.18.

Definition 2.19 *A discrete A-net $f : \mathbb{Z}^M \rightarrow \mathbb{R}^3$ is called an M-dimensional discrete K-net, if for any elementary quadrilateral $(f, \tau_i f, \tau_i \tau_j f, \tau_j f)$ there holds:*

$$|\tau_i \tau_j f - \tau_j f| = |\tau_i f - f| \quad \text{and} \quad |\tau_i \tau_j f - \tau_i f| = |\tau_j f - f|,$$

in other words, if for any $i = 1, \dots, M$, the function $\alpha_i = |\delta_i f|$ (defined on the edges parallel to the coordinate axes \mathcal{B}_i) depends on u_i only.

This notion is due to Sauer [Sa] in the case $M = 2$ and to Wunderlich [W] in the case $M = 3$. A study of discrete K-surfaces within the framework of the theory of integrable systems was performed in [BobP1].

A characterization of the Lelievre normal field of a discrete K-net is analogous to the smooth case.

Theorem 2.20 *The Lelievre normal field $n : \mathbb{Z}^M \rightarrow \mathbb{R}^3$ of a discrete K-net $f : \mathbb{Z}^M \rightarrow \mathbb{R}^3$ takes values, possibly upon a black-white rescaling, in some sphere $S^2 \subset \mathbb{R}^3$. In case when the radius of this sphere is equal to 1 (which we associate to the discrete Gaussian curvature $K = -1$), the Lelievre normal field coincides with the Gauss map. Conversely, any T-net n in the unit sphere S^2 is the Gauss map and the Lelievre normal field of a discrete K-net f with $K = -1$. The functions $\beta_i = |\delta_i n|$ depend on u_i only, and are related to the functions $\alpha_i = |\delta_i f|$ by $\alpha_i = \beta_i(1 - \beta_i^2/4)^{1/2}$.*

Thus, discrete K-nets are in a one-to-one correspondence with T-nets in S^2 . We proceed to the study of the latter object.

M=2: basic 2D system. If two coordinate curves of the Gauss map n of a discrete K-surface f are given, that is, $n|_{\mathcal{B}_1}$ and $n|_{\mathcal{B}_2}$, then one

can extend n to the whole of \mathbb{Z}^2 . An inductive step in extending n to \mathbb{Z}_+^2 consists of computing $\tau_1\tau_2n = n + a_{12}(\tau_2n - \tau_1n)$, where the coefficient a_{12} (attached to every elementary square of the discrete surface) is determined by the condition that $\tau_1\tau_2n \in \mathbb{S}^2$, so that

$$a_{12} = \frac{\langle n, \tau_1n - \tau_2n \rangle}{1 - \langle \tau_1n, \tau_2n \rangle}.$$

This elementary construction step, i.e., finding the fourth vertex of an elementary square out of the known three vertices, is symbolically represented on Fig. 2.5.

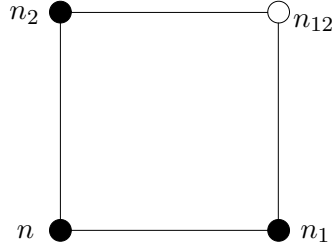

Figure 2.5: 2D system on an elementary quadrilateral

$M \geq 3$: consistency. Turning to the case $M \geq 3$, we see that one can prescribe all coordinate lines of a T-net n in \mathbb{S}^2 , i.e., $n|_{\mathcal{B}_i}$ for all $1 \leq i \leq M$. Indeed, these data are independent, and one can, by induction, construct the whole net from them. The inductive step is essentially two-dimensional and consists of determining $\tau_i\tau_jn$, provided n , τ_in and τ_jn are known. In order for this inductive process to work without contradictions, equations

$$\tau_i\tau_jn - n = a_{ij}(\tau_jn - \tau_in), \quad a_{ij} = \frac{\langle n, \tau_in - \tau_jn \rangle}{1 - \langle \tau_in, \tau_jn \rangle} \quad (2.55)$$

must have a very special property. To see this, consider in detail the case of $M = 3$; higher dimensions do not add anything new. From n and n_i one determines all n_{ij} uniquely. After that, one has, in principle, three different ways to determine n_{123} , from three squares adjacent to this point; see Fig. 2.6. These three values for n_{123} have to coincide, independently of initial conditions.

Definition 2.21 *A 2D system is called 3D consistent, if it can be imposed on all two-dimensional faces of an elementary cube of \mathbb{Z}^3 .*

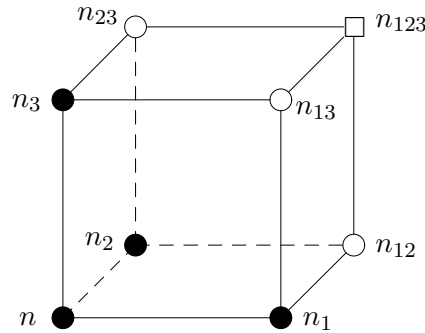

Figure 2.6: 3D consistency of 2D systems

Theorem 2.22 *The 2D system (2.55) governing T-nets in \mathbb{S}^2 is 3D consistent.*

Proof. This can be checked by a tiresome computation, which can be however avoided by the following conceptual argument. Note that T-nets in \mathbb{S}^2 are a result of imposing of two admissible reductions on Q-nets, namely the T-reduction and the restriction to a quadric \mathbb{S}^2 . This reduces the effective dimension of the system by 1 (allows to determine the fourth vertex of an elementary quadrilateral from the three known ones), and transfers the original 3D equation into the 3D consistency of the reduced 2D equation. Indeed, after finding n_{12} , n_{23} and n_{13} , one can construct n_{123} according to the Q-condition (as intersection of three planes). Then both the T-condition and the \mathbb{S}^2 -condition are fulfilled for all three quadrilaterals adjacent to n_{123} . Therefore, these quadrilaterals satisfy our 2D system. Note that this argument holds also for T-nets in an arbitrary quadric (not necessarily in \mathbb{S}^2). \square

Thus, we have for $M \geq 3$ a system consisting of interrelated two-dimensional building blocks (2.55), for all pairs of indices i, j between 1 and M . The M -dimensional consistency of this system means that all two-dimensional building blocks can be imposed without contradictions. A set of initial data which determines a solution of the system (2.55) consists of

(\mathbb{K}^Δ) values of n on the coordinate axes \mathcal{B}_i for $1 \leq i \leq M$.

Transformations of discrete K-nets. A natural generalization of Definition 1.19 would be the following one.

Definition 2.23 A Weingarten pair of discrete K-nets $f, f^+ : \mathbb{Z}^m \rightarrow \mathbb{R}^3$ is called a Bäcklund pair, if the distance $|f^+ - f|$ is constant, i.e., does not depend on $u \in \mathbb{Z}^m$.

But, comparing this with Definition 2.19, we see that the net $F : \mathbb{Z}^m \times \{0, 1\} \rightarrow \mathbb{R}^3$ with $F(u, 0) = f(u)$ and $F(u, 1) = f^+(u)$ is an M -dimensional discrete K-net, where $M = m + 1$. Once more, transformations of discrete K-nets do not differ from the nets themselves. To specify a Bäcklund transform f^+ of a given m -dimensional discrete K-net f , or a Moutard transform n^+ of the Gauss map n , one can prescribe the following data:

(B $^\Delta$) value of $n^+(0)$.

We will be mainly interested in transformations of discrete K-surfaces. After the usual change of variables (2.52) we will have for the Gauss map the equation

$$\tau_1 \tau_2 n + n = a_{12}(\tau_1 n + \tau_2 n), \quad a_{12} = \frac{\langle n, \tau_1 n + \tau_2 n \rangle}{1 + \langle \tau_1 n, \tau_2 n \rangle}, \quad (2.56)$$

while for its transformation we will have the equations

$$\tau_1 n^+ - n = b_1(n^+ - \tau_1 n), \quad b_1 = \frac{\langle n, \tau_1 n - n^+ \rangle}{1 - \langle \tau_1 n, n^+ \rangle}, \quad (2.57)$$

$$\tau_2 n^+ + n = b_2(n^+ + \tau_2 n), \quad b_2 = \frac{\langle n, \tau_2 n + n^+ \rangle}{1 + \langle \tau_2 n, n^+ \rangle}. \quad (2.58)$$

Of course, this has to be supplied with the Lelievre formulas (2.53) and (2.54). Permutability of Bäcklund transformations for discrete K-surfaces is a direct consequence of the 3D consistency of T-nets in \mathbb{S}^2 , and the smooth result (Theorem 1.20) will be derived in Sect. 3.7 by the continuous limit.

2.6 Discrete isothermic nets

Discrete isothermic surfaces were introduced in [BobP2]. See also [HeHP, He1, He2, Sch1] for further developments.

Definition 2.24 A discrete O-surface $f : \mathbb{Z}^2 \rightarrow \mathbb{R}^N$ is called a discrete I-surface (discrete isothermic surface), if the cross-ratios of its elementary quadrilaterals satisfy

$$q(f, f_1, f_{12}, f_2) = -\frac{\alpha_1}{\alpha_2}, \quad (2.59)$$

where the functions α_i depend on u_i only ($i = 1, 2$), and the usual notations $f_i = \tau_i f$, $f_{12} = \tau_1 \tau_2 f$ are used.

It is natural to consider the functions α_i as defined on edges of \mathbb{Z}^2 parallel to the coordinate axes \mathcal{B}_i , with the property that any two opposite edges of any elementary square carry the same value of the corresponding α_i . Such functions α_i will be called a *labelling* of the edges of \mathbb{Z}^2 . Actually, it will be more convenient to associate $-\alpha_2$ to the edges parallel to \mathcal{B}_2 . To determine a labelling, one has to prescribe it on the coordinate axes \mathcal{B}_i . Thus, discrete I-surfaces are governed by a 2D equation (2.59), and the following initial data determine such a surface completely:

(I₁^Δ) values of f in the coordinate axes \mathcal{B}_i ($i = 1, 2$), i.e., two discrete curves $f|_{\mathcal{B}_i}$ with a common intersection point $f(0)$;

(I₂^Δ) two functions $\alpha_i : \mathcal{B}_i \rightarrow \mathbb{R}$ on the edges of the coordinate axes \mathcal{B}_i for $i = 1, 2$, which yield an edge labelling, $\alpha_i = \alpha_i(u_i)$.

A discrete analog of the function s from eq. (1.51) is defined on the vertices of \mathbb{Z}^2 .

Theorem 2.25 *For a discrete isothermic surface f , there exists a function $s : \mathbb{Z}^2 \rightarrow \mathbb{R}$ (positive if both $\alpha_i > 0$), such that*

$$|f_i - f|^2 = \alpha_i s s_i \quad (i = 1, 2). \quad (2.60)$$

It is defined uniquely, up to a black-white rescaling (which is fixed by prescribing s at one point, say at $u = 0$). Conversely, existence of such a function s for a discrete O-surface f implies that f is isothermic.

The following property actually characterizes discrete isothermic surfaces.

Theorem 2.26 (Dual discrete I-surface) *Let $f : \mathbb{Z}^2 \rightarrow \mathbb{R}^N$ be a discrete isothermic surface. Then the \mathbb{R}^N -valued discrete one-form δf^* defined by*

$$\delta_1 f^* = \alpha_1 \frac{\delta_1 f}{|\delta_1 f|^2} = \frac{\delta_2 f}{s s_1}, \quad \delta_2 f^* = -\alpha_2 \frac{\delta_2 f}{|\delta_2 f|^2} = -\frac{\delta_2 f}{s s_2}, \quad (2.61)$$

is closed. Its integration defines (up to a translation) a surface $f^ : \mathbb{Z}^2 \rightarrow \mathbb{R}^N$, called dual to the surface f , or Christoffel transform of the surface f . The surface f^* is discrete isothermic, with*

$$q(f^*, f_1^*, f_{12}^*, f_2^*) = -\frac{\alpha_1}{\alpha_2}. \quad (2.62)$$

Proof. We rewrite eq. (2.59) in several equivalent forms. Recall that in this equation we regard f as belonging to the Clifford algebra $\mathcal{Cl}(\mathbb{R}^N)$, and that the cross-ratio is defined by eq. (1.56). One checks straightforwardly that eq. (2.59) is equivalent to:

$$(\alpha_1 + \alpha_2)(f_{12} - f)^{-1} = \alpha_1(f_1 - f)^{-1} + \alpha_2(f_2 - f)^{-1}, \quad (2.63)$$

or, interchanging the roles of f and f_{12} , to:

$$(\alpha_1 + \alpha_2)(f_{12} - f)^{-1} = \alpha_1(f_{12} - f_2)^{-1} + \alpha_2(f_{12} - f_1)^{-1}. \quad (2.64)$$

Taking into account that $(f_i - f)^{-1} = -(f_i - f)/|f_i - f|^2$, we find:

$$\alpha_1 \frac{f_1 - f}{|f_1 - f|^2} + \alpha_2 \frac{f_2 - f}{|f_2 - f|^2} = \alpha_1 \frac{f_{12} - f_2}{|f_{12} - f_2|^2} + \alpha_2 \frac{f_{12} - f_1}{|f_{12} - f_1|^2}, \quad (2.65)$$

or, due to (2.60),

$$\frac{f_1 - f}{s s_1} + \frac{f_2 - f}{s s_2} = \frac{f_{12} - f_2}{s_2 s_{12}} + \frac{f_{12} - f_1}{s_1 s_{12}}, \quad (2.66)$$

This is equivalent to the first statement of the theorem. The second one follows readily from the Clifford algebra expressions $f_1^* - f^* = \alpha_1(f_1 - f)^{-1}$ and $f_2^* - f^* = -\alpha_2(f_2 - f)^{-1}$. Note that $|f_i^* - f^*|^2 = \alpha_i^2 |f_i - f|^{-2} = \alpha_i (s s_i)^{-1}$, so that $s^* = s^{-1}$ can be taken as the analog of the function s for the dual surface f^* . \square

Definition 2.27 (Discrete Darboux transformation) *A Ribaucour transform $f^+ : \mathbb{Z}^2 \rightarrow \mathbb{R}^N$ of a given discrete isothermic surface $f : \mathbb{Z}^2 \rightarrow \mathbb{R}^N$ is called a Darboux transform, if the cross-ratios of its elementary quadrilaterals can be likewise factorized:*

$$q(f^+, f_1^+, f_{12}^+, f_2^+) = -\frac{\alpha_1}{\alpha_2}. \quad (2.67)$$

It can be demonstrated that, apart from the trivial case when f^+ is a Möbius transform of f , the Darboux transform is given by the following formulas:

$$q(f, f_1, f_1^+, f^+) = \frac{\alpha_1}{c}, \quad q(f, f_2, f_2^+, f^+) = -\frac{\alpha_2}{c}. \quad (2.68)$$

where $c \in \mathbb{R}$ is its *parameter*. Clearly, following data determine a Darboux transform f^+ of a given discrete isothermic surface f uniquely:

(D₁^Δ) a point $f^+(0)$;

(D_2^Δ) a real number c , the parameter of the transformation.

Comparing formulas (2.59), (2.67), and (2.68), we see that iterating a Darboux transformation is nothing but adding a third dimension to a two-dimensional discrete isothermic net, $f^+ = f_3$. The parameter c plays the role of the function α_3 , attached to all edges parallel to the third lattice direction. Formula (2.60) for the third direction reads:

$$|f^+ - f|^2 = css^+ \quad (2.69)$$

(which literally coincides with the corresponding formula (1.55) for the smooth case). All this is possible due to the following fundamental statement about multidimensional discrete isothermic nets:

Theorem 2.28 *The 2D cross-ratio equation*

$$q(f, f_i, f_{ij}, f_j) = \frac{\alpha_i}{\alpha_j} \quad (2.70)$$

is 3D consistent for any labelling α_i of the edges.

This statement is due to [HeHP]; its generalization, where $\mathcal{C}\ell(\mathbb{R}^N)$ is replaced by an arbitrary associative algebra, was proven in [BobSu2], and will be given in Theorem 4.4.

Remark. In view of the fundamental importance of the consistency property which holds if the right-hand side of the cross-ratio system is factorized as in (2.70), one might wonder why we introduced the minus sign in eq. (2.59) for discrete I-surfaces, which propagated also into eq. (2.68) for the Darboux transformations. This choice is motivated by the convenience of passing to the continuous limit only. The fundamental factorization form (2.70) is restored by the change $\alpha_2 \rightarrow -\alpha_2$.

Möbius-geometric characterization of discrete isothermic surfaces. Cross-ratio of four concircular points is a Möbius invariant quantity. Therefore, the notions of discrete isothermic surfaces and of their Darboux transformations are also Möbius invariant. To give their characterization within the Möbius-geometric formalism, we note first of all that, according to Theorem 2.10, eq. (2.66) holds also for the image \hat{f} of the net f in the quadric \mathbb{Q}_0^N :

$$\frac{\hat{f}_1 - \hat{f}}{s s_1} + \frac{\hat{f}_2 - \hat{f}}{s s_2} = \frac{\hat{f}_{12} - \hat{f}_2}{s_2 s_{12}} + \frac{\hat{f}_{12} - \hat{f}_1}{s_1 s_{12}}.$$

This yields a discrete analog of Theorem 1.25:

Theorem 2.29 *The lift $\hat{s} = s^{-1}\hat{f} : \mathbb{Z}^2 \rightarrow \mathbb{L}^{N+1}$ of f to the light cone of $\mathbb{R}^{N+1,1}$ satisfies the discrete Moutard equation*

$$\tau_1\tau_2\hat{s} + \hat{s} = a_{12}(\tau_1\hat{s} + \tau_2\hat{s}), \quad (2.71)$$

with $a_{12} = (\tau_1\tau_2s^{-1} + s^{-1})/(\tau_1s^{-1} + \tau_2s^{-1})$.

Conversely, given a discrete M-net $\hat{s} : \mathbb{Z}^2 \rightarrow \mathbb{L}^{N+1}$ in the light cone, let the functions $s : \mathbb{Z}^2 \rightarrow \mathbb{R}_+$ and $f : \mathbb{Z}^2 \rightarrow \mathbb{R}^N$ be defined by

$$\hat{s} = s^{-1}(f + \mathbf{e}_0 + |f|^2\mathbf{e}_\infty)$$

(so that s^{-1} is the \mathbf{e}_0 -component, and $s^{-1}f$ is the \mathbb{R}^N -part of \hat{s} in the basis $\mathbf{e}_1, \dots, \mathbf{e}_N, \mathbf{e}_0, \mathbf{e}_\infty$). Then f is a discrete isothermic surface.

Eq. (2.71) is a 2D equation in \mathbb{L}^{N+1} which determines $\tau_1\tau_2\hat{s}$ from \hat{s} , $\tau_1\hat{s}$, $\tau_2\hat{s}$. This yields:

$$a_{12} = \frac{\langle \hat{s}, \tau_1\hat{s} + \tau_2\hat{s} \rangle}{\langle \tau_1\hat{s}, \tau_2\hat{s} \rangle}. \quad (2.72)$$

From this one readily sees that for a discrete M-net in \mathbb{L}^{N+1} the quantities $\langle \hat{s}, \tau_i\hat{s} \rangle$ depend on u_i only. They are related to the labelling α_i of Definition 2.24 by $\langle \hat{s}, \tau_i\hat{s} \rangle = -\alpha_i/2$. Thus, the labelling is already encoded in the lift \hat{s} of a discrete I-surface f .

For the consistent cross-ratio system (2.70) one can introduce the scalar function $s : \mathbb{Z}^M \rightarrow \mathbb{R}$ (not necessarily positive) according to eq. (2.60) with $1 \leq i \leq M$, which yields a multidimensional version of the lift $\hat{s} = s^{-1}\hat{f} : \mathbb{Z}^M \rightarrow \mathbb{L}^{N+1}$. It satisfies a discrete Moutard equation with minus signs:

$$\tau_i\tau_j\hat{s} - \hat{s} = a_{ij}(\tau_j\hat{s} - \tau_i\hat{s}). \quad (2.73)$$

This is an instance of 3D consistent T-nets in a quadric (see the proof of Theorem 2.22), and describes Darboux transformations of discrete I-surfaces and their permutability properties. To perform a smooth limit a usual change of signs (see Sect.2.3) is required. This results in eq. (2.71) for the surface and in

$$\tau_1\hat{s}^+ - \hat{s} = b_1(\hat{s}^+ - \tau_1\hat{s}), \quad \tau_2\hat{s}^+ + \hat{s} = b_2(\hat{s}^+ + \tau_2\hat{s}) \quad (2.74)$$

for its Darboux transformations.

2.7 Discrete surfaces made of spheres

It is common to think of discrete surfaces as of maps $f : \mathbb{Z}^2 \rightarrow \mathbb{R}^N$. However, it is not the only possibility. One of the further ideas is to “blow up” the points f , making them to (small) hyperspheres in \mathbb{R}^N . We discuss here two realizations of this idea, which generalize the notions of discrete O-nets and of discrete I-surfaces, maintaining important features of these notions, including transformations with permutability properties.

S-orthogonal nets. We first generalize M -dimensional discrete O-nets f in \mathbb{R}^N . Blowing up the points to spheres is done in the following way:

Definition 2.30 *An S-circular net is a map*

$$S : \mathbb{Z}^M \rightarrow \{\text{non-oriented hyperspheres in } \mathbb{R}^N\} \quad (2.75)$$

such that, for any elementary square of \mathbb{Z}^M , the corresponding four hyperspheres S , $\tau_i S$, $\tau_j S$ and $\tau_i \tau_j S$ have a common orthogonal circle.

Clearly, this reduces to Definition 2.6, if the radii of all hyperspheres become infinitely small. Observe also that the plane of the common orthogonal circle contains the Euclidean centers of all four hyperspheres.

Recall (see Appendix to Chapter 1) that hyperspheres in \mathbb{R}^N can be represented as elements of $\mathbb{P}(\mathbb{R}_{\text{out}}^{N+1,1})$, where

$$\mathbb{R}_{\text{out}}^{N+1,1} = \{\hat{s} \in \mathbb{R}^{N+1,1} : \langle \hat{s}, \hat{s} \rangle > 0\} \quad (2.76)$$

is the space-like part of $\mathbb{R}^{N+1,1}$. Thus, blowing up points to spheres corresponds to the step away from \mathbb{L}^{N+1} to $\mathbb{R}_{\text{out}}^{N+1,1}$. To establish a characterization of S-circular nets similar to that of Theorem 2.10, the following statement is needed.

Theorem 2.31 *Four points of $\mathbb{R}_{\text{out}}^{N+1,1}$ are linearly dependent if and only if the corresponding four hyperspheres in \mathbb{R}^N*

- (i) *have a common orthogonal circle, or*
- (ii) *intersect along an $(N - 3)$ -sphere, or else*
- (iii) *intersect at exactly one point.*

Case (iii) can be regarded as a degenerate case of both (i) and (ii).

The distinction between these three cases depends on the signature of the quadratic form obtained as the restriction of the Minkowski scalar product to the $(N - 1)$ -dimensional (Lorentz-)orthogonal complement of the three-dimensional vector subspace of $\mathbb{R}^{N+1,1}$ spanned by our four points. This form is positive-definite in the case (i), it has the signature $(N - 2, 1)$ in the case (ii), and it is degenerate in the case (iii). It is understood that for $N = 3$ the 0-sphere in the case (ii) is a point pair.

Since it is difficult to control the signature of this quadratic form, it makes sense to introduce a notion which is somewhat wider than that of a S-circular net.

Definition 2.32 *An S-orthogonal net is a map (2.75) such that, for any elementary square of \mathbb{Z}^M , the points \hat{s} , $\tau_i \hat{s}$, $\tau_j \hat{s}$ and $\tau_i \tau_j \hat{s}$, corresponding to four spheres S , $\tau_i S$, $\tau_j S$ and $\tau_i \tau_j S$, are linearly dependent.*

For $N = 3$, S-orthogonal nets with all intersections of type (ii) are natural discrete analogs of sphere congruences parametrized along principal lines, because four infinitesimally neighboring spheres of such a congruence intersect this way, the pairs of intersection points comprising two enveloping surfaces of the congruence (see, e.g., [E2]).

Theorem 2.33 *Six circles (corresponding to the faces) of an elementary cube of a S-circular net lie on a 2-sphere. For $N = 3$ these spheres comprise an S-orthogonal net.*

A convenient choice of representatives \hat{s} of hyperspheres S in a fixed affine hyperplane of $\mathbb{R}_{\text{out}}^{N+1,1}$ is given by eq. (1.65). Therefore:

Theorem 2.34 *A map (2.75) is an S-orthogonal net, if and only if the corresponding map*

$$\hat{s} : \mathbb{Z}^M \rightarrow \mathbb{R}_{\text{out}}^{N+1,1} \cap \{\xi_0 = 1\}, \quad \hat{s} = c + \mathbf{e}_0 + (|c|^2 - r^2)\mathbf{e}_\infty,$$

is a discrete Q-net in $\mathbb{R}^{N+1,1}$, i.e., if the centers $c : \mathbb{Z}^M \rightarrow \mathbb{R}^N$ of the spheres S form a discrete Q-net in \mathbb{R}^N , and their radii $r : \mathbb{Z}^M \rightarrow \mathbb{R}_+$ are such that the function $|c|^2 - r^2$ satisfies the same equation (2.1) as the centers c .

A smooth version of this theorem for arbitrary sphere congruences in \mathbb{R}^3 parametrized along principal lines can be found, e.g., in [E2], §99.

The multidimensional consistency of discrete quadrilateral nets can be immediately transferred into the corresponding property of S-orthogonal nets, with the following reservation: given seven points \hat{s} , $\tau_i \hat{s}$, $\tau_i \tau_j \hat{s}$ in

$\mathbb{R}_{\text{out}}^{N+1,1} \cap \{\xi_0 = 1\}$, the Q-property (planarity condition) uniquely defines the eighth point $\tau_1\tau_2\tau_3\hat{s}$ in $\mathbb{R}^{N+1,1} \cap \{\xi_0 = 1\}$, which, however, might get outside of $\mathbb{R}_{\text{out}}^{N+1,1}$, and therefore might not represent a real hypersphere. Thus, the corresponding discrete 3D system is well-defined only on a proper open subset of the definition domain. As long as it is defined, it can be used to produce ‘‘S-Ribaucour’’ transformations of S-orthogonal nets, with usual permutability properties.

S-isothermic surfaces. Recall that, according to Theorem 2.29, discrete I-surfaces are characterized as discrete M-surfaces (or T-surfaces) in \mathbb{L}^{N+1} . In this context, we blow up points to spheres by replacing \mathbb{L}^{N+1} by $\mathbb{L}_{\kappa}^{N+1}$ (see eqs. (1.66), (1.67)):

Definition 2.35 *A map $S : \mathbb{Z}^2 \rightarrow \{\text{oriented hyperspheres in } \mathbb{R}^N\}$ is called an S-isothermic surface, if the corresponding map $\hat{s} : \mathbb{Z}^2 \rightarrow \mathbb{L}_{\kappa}^{N+1}$ is a discrete M-surface (T-surface).*

S-isothermic surfaces, along with their dual surfaces were originally introduced in [BobP3] for the special case of touching spheres. The general class of Definition 2.35, together with Darboux transformations and dual surfaces, is due to [Ho].

S-isothermic surfaces are governed by the equation (2.71) with

$$a_{12} = \frac{\langle \hat{s}, \tau_1 \hat{s} + \tau_2 \hat{s} \rangle}{\kappa^2 + \langle \tau_1 \hat{s}, \tau_2 \hat{s} \rangle}, \quad (2.77)$$

and have the property that the quantities $\alpha_i = \langle \hat{s}, \tau_i \hat{s} \rangle$ depend on u_i only. If radii of all hyperspheres become uniformly small, $r(u) \sim \kappa s(u)$, $\kappa \rightarrow 0$, then in the limit we recover discrete isothermic surfaces, as characterized in Theorem 2.29.

Consistency of discrete T-nets in $\mathbb{L}_{\kappa}^{N+1}$ implies, in particular, Darboux transformations for S-isothermic surfaces, governed by eq. (2.73). A Darboux transform $\hat{s}^+ : \mathbb{Z}^2 \rightarrow \mathbb{L}_{\kappa}^{N+1}$ of a given S-isothermic surface \hat{s} is uniquely specified by a choice of one of its spheres $\hat{s}^+(0)$.

Geometric properties of S-isothermic surfaces are the following. First of all, S-isothermic surfaces form a subclass of S-orthogonal nets. Further, the quantities $\langle \hat{s}, \tau_i \hat{s} \rangle$ depend on u_i only, and have the meaning of cosines of the intersection angles of the neighboring spheres (resp., of their so called inversive distances if they do not intersect). An important characterization is the following generalization of Theorem 2.26.

Theorem 2.36 (Dual S-isothermic surface)

Let $S : \mathbb{Z}^2 \rightarrow \{\text{oriented hyperspheres in } \mathbb{R}^N\}$ be an S -isothermic surface. Denote the Euclidean centers and radii of S by $c : \mathbb{Z}^2 \rightarrow \mathbb{R}^N$ and $r : \mathbb{Z}^2 \rightarrow \mathbb{R}$, respectively. Then the \mathbb{R}^N -valued discrete one-form δc^* defined by

$$\delta_1 c^* = \frac{\delta_1 c}{rr_1}, \quad \delta_2 c^* = -\frac{\delta_2 c}{rr_2} \quad (2.78)$$

is closed, so that its integration defines (up to a translation) a function $c^* : \mathbb{Z}^2 \rightarrow \mathbb{R}^N$. Define also $r^* : \mathbb{Z}^2 \rightarrow \mathbb{R}$ by $r^* = r^{-1}$. Then the hyperspheres S^* with the centers c^* and radii r^* form an S -isothermic surface, called dual to S .

Proof. Consider eq. (2.71), in terms of

$$\hat{s} = r^{-1}(c + \mathbf{e}_0 + (|c|^2 - r^2)\mathbf{e}_\infty).$$

Its \mathbf{e}_0 -part yields: $a_{12} = (r_{12}^{-1} + r^{-1})/(r_1^{-1} + r_2^{-1})$. This allows us to rewrite eq. (2.71) as

$$(r_1^{-1} + r_2^{-1})(\hat{s}_{12} + \hat{s}) = (r_{12}^{-1} + r^{-1})(\hat{s}_1 + \hat{s}_2). \quad (2.79)$$

A direct computation shows that the \mathbb{R}^N -part of this equation can be rewritten as

$$\frac{c_1 - c}{rr_1} + \frac{c_2 - c}{rr_2} = \frac{c_{12} - c_2}{r_2 r_{12}} + \frac{c_{12} - c_1}{r_1 r_{12}}, \quad (2.80)$$

which is equivalent to closeness of the form δc^* defined by (2.78). In the same way, the \mathbf{e}_∞ -part of eq. (2.79) is equivalent to closeness of the discrete form δw defined by

$$\delta_1 w = \frac{\delta_1(|c|^2 - r^2)}{rr_1}, \quad \delta_2 w = -\frac{\delta_2(|c|^2 - r^2)}{rr_2}.$$

For similar reasons, the second claim of the theorem is equivalent to the closeness of the form

$$\delta_1 z = \frac{\delta_1(|c^*|^2 - (r^*)^2)}{r^* r_1^*}, \quad \delta_2 z = -\frac{\delta_2(|c^*|^2 - (r^*)^2)}{r^* r_2^*}.$$

But one easily checks that

$$\begin{aligned} \delta_1 w &= \langle c_1^* - c^*, c_1 + c \rangle - \frac{r_1}{r} + \frac{r}{r_1}, & \delta_2 w &= \langle c_2^* - c^*, c_2 + c \rangle + \frac{r_2}{r} - \frac{r}{r_2}, \\ \delta_1 z &= \langle c_1 - c, c_1^* + c^* \rangle - \frac{r}{r_1} + \frac{r_1}{r}, & \delta_2 z &= \langle c_2 - c, c_2^* + c^* \rangle + \frac{r}{r_2} - \frac{r_2}{r}. \end{aligned}$$

The sum of these two one-forms is closed:

$$\delta_1(w + z) = 2\langle c_1^*, c_1 \rangle - 2\langle c^*, c \rangle, \quad \delta_2(w + z) = 2\langle c_2^*, c_2 \rangle - 2\langle c^*, c \rangle,$$

therefore they are closed simultaneously. \square

Chapter 3

Approximation

3.1 Discrete hyperbolic systems

To formulate the most general scheme covering all the situations encountered so far, we have to put our hyperbolic systems into the first order form. It should be stressed that this is necessary only for general theoretical considerations, and will never be done for concrete examples.

Definition 3.1 *A hyperbolic system of first order partial difference equations is a system of the form*

$$\delta_i x_k = g_{k,i}(x), \quad i \in \mathcal{E}_k. \quad (3.1)$$

for functions $x_k : \mathbb{Z}^M \rightarrow \mathcal{X}_k$ with values in Banach spaces \mathcal{X}_k . For each x_k , eqs. (3.1) are given for $i \in \mathcal{E}_k \subset \{1, \dots, M\}$, the evolution directions of x_k . The complement $\mathcal{S}_k = \{1, \dots, M\} \setminus \mathcal{E}_k$ consists of static directions of x_k .

We think of the variable $x_k(u)$ as attached to the elementary cell \mathcal{C}_k of dimension $\#\mathcal{S}_k$ adjacent to the point $u \in \mathbb{Z}^M$ and parallel to $\mathcal{B}_{\mathcal{S}_k}$:

$$\mathcal{C}_k = \left\{ u + \sum_{i \in \mathcal{S}_k} \mu_i e_i : \mu_i \in [0, 1] \right\}.$$

Here, recall,

$$\mathcal{B}_{\mathcal{S}} = \{u \in \mathbb{Z}^M : u_i = 0 \text{ if } i \notin \mathcal{S}\},$$

for an index set $\mathcal{S} \subset \{1, \dots, M\}$.

Definition 3.2

1) *A local Goursat problem for the hyperbolic system (3.1) consists of finding a solution x_k for all k and for all cells \mathcal{C}_k within the elementary*

cube of \mathbb{Z}^M at the origin from the prescribed values $x_k(0)$. A global Goursat problem consists of finding a solution of (3.1) on \mathbb{Z}^M subject to the following initial data:

$$x_k|_{\mathcal{B}_{\mathcal{S}_k}} = X_k, \quad (3.2)$$

where $X_k : \mathcal{B}_{\mathcal{S}_k} \rightarrow \mathcal{X}_k$ are given functions.

2) The system (3.1) is called consistent, if the local Goursat problem for it is uniquely solvable for arbitrary initial data $x(0)$.

The following rather obvious but extremely important statement holds:

Theorem 3.3 *A Goursat problem for a consistent hyperbolic system (3.1) has a unique solution x on all of \mathbb{Z}^M .*

Consistency conditions read: $\delta_j \delta_i x_k = \delta_i \delta_j x_k$ for all $i \neq j$. Substituting eqs. (3.1), one gets the following equations:

$$\delta_j g_{k,i}(x) = \delta_i g_{k,j}(x), \quad i \neq j, \quad (3.3)$$

or $g_{k,i}(x + g_j(x)) - g_{k,i}(x) = g_{k,j}(x + g_i(x)) - g_{k,j}(x)$, where $g_i(x)$ is a vector function whose ℓ -th component is equal to $g_{\ell,i}(x)$, if $i \in \mathcal{E}_\ell$, and is undefined otherwise.

Lemma 3.4 *For a consistent system of hyperbolic equations (3.1), the function $g_{k,i}$ depends on those components x_ℓ only for which $\mathcal{S}_\ell \subset \mathcal{S}_k \cup \{i\}$.*

Proof. Eqs. (3.3) have to hold identically in x . This implies that the function $g_{k,i}$ can depend on those components x_ℓ only, for which $\delta_j x_\ell$ is defined, i.e., for which $j \in \mathcal{E}_\ell$. As (3.3) has to be satisfied for all $j \in \mathcal{E}_k$, $j \neq i$, one obtains that for these ℓ there holds $\mathcal{E}_k \setminus \{i\} \subset \mathcal{E}_\ell$. \square

It follows from Lemma 3.4 that for any subset $\mathcal{S} \subset \{1, \dots, M\}$, equations of (3.1) for k with $\mathcal{S}_k \subset \mathcal{S}$ and for $i \in \mathcal{S}$ form a closed subsystem, in the sense that $g_{k,i}$ depend on x_ℓ with $\mathcal{S}_\ell \subset \mathcal{S}$ only.

Definition 3.5 *The essential dimension d of the system (3.1) is given by*

$$d = 1 + \max_k (\#\mathcal{S}_k). \quad (3.4)$$

If $d = M$, system (3.1) has no lower-dimensional hyperbolic subsystems. If $d < M$, then d -dimensional subsystems corresponding to \mathcal{S} with $\#\mathcal{S} = d$ are hyperbolic. In this case, **consistency** of system (3.1) is a manifestation of a very special property of its d -dimensional subsystems, which we suggest to treat as the **discrete integrability** (at least under some further conditions, excluding certain non-interesting situations, like trivial evolution in some of the directions). Sect. 4 will be devoted to giving a solid background for this suggestion in the case $d = 2$.

3.2 Discrete approximation in hyperbolic systems

To handle with approximation results for discrete geometric models, we need to introduce small parameters into hyperbolic systems of partial difference equations. The definition domain of our functions becomes

$$\mathcal{B}^\epsilon = \epsilon_1 \mathbb{Z} \times \cdots \times \epsilon_M \mathbb{Z}.$$

If $\epsilon_i = 0$ for some index i , the respective component in \mathcal{B}^ϵ is replaced by \mathbb{R} . For instance, if $\epsilon = (0, \dots, 0)$, then $\mathcal{B}^\epsilon = \mathbb{R}^M$. So the domains \mathcal{B}^ϵ possess continuous and discrete directions, with mesh sizes depending on the parameters ϵ_i . Definitions of translations and difference quotients are modified for functions on \mathcal{B}^ϵ in an obvious way:

$$(\tau_i f)(u) = f(u + \epsilon_i e_i), \quad (\delta_i f)(u) = \frac{1}{\epsilon_i} (f(u + \epsilon_i e_i) - f(u)).$$

If $\epsilon_i = 0$, then δ_i is naturally replaced by the partial derivative ∂_i . For a multi-index $\alpha = (\alpha_1, \dots, \alpha_M)$, we set $\delta^\alpha = \delta_1^{\alpha_1} \cdots \delta_M^{\alpha_M}$.

The definition of elementary cells \mathcal{C}_k , carrying the variables x_k , is modified as follows:

$$\mathcal{C}_k = \left\{ u + \sum_{i \in \mathcal{S}_k} \mu_i e_i : \mu_i \in [0, \epsilon_i] \right\}$$

(so that the cell size shrinks to zero in the directions with $\epsilon_i = 0$). We see how the discreteness helps to organize the ideas: in the continuous case, when all $\epsilon_i = 0$, all the functions x_k live at *points*, independently on the dimensions $\#\mathcal{S}_k$ of their static spaces. In the discrete case, when all $\epsilon_i > 0$, one can clearly distinguish between functions living on vertices (those without static directions), on edges (those with exactly one static direction), on elementary squares (those with exactly two static directions), etc.

Having in mind the limit $\epsilon \rightarrow 0$, we will treat only the case when the first $m \leq M$ parameters go to zero, $\epsilon_1 = \cdots = \epsilon_m = \epsilon$, while the other $M - m$ ones remain constant, $\epsilon_{m+1} = \cdots = \epsilon_M = 1$. Thus, in this case $\mathcal{B}^\epsilon = (\epsilon \mathbb{Z})^m \times \mathbb{Z}^{M-m}$, and we set $\mathcal{B} = \mathcal{B}^0 = \mathbb{R}^m \times \mathbb{Z}^{M-m}$. Assuming that the functions $g_{k,i} = g_{k,i}^\epsilon$ on the right-hand sides of (3.1) depend on ϵ smoothly and have limits as $\epsilon \rightarrow 0$, we will study the convergence of solutions x^ϵ of the difference hyperbolic system (3.1) towards solutions x^0 of the limiting differential(-difference) hyperbolic system

$$\partial_i x_k = g_{k,i}^0(x), \quad 1 \leq i \leq m, \quad (3.5)$$

$$\delta_i x_k = g_{k,i}^0(x), \quad m+1 \leq i \leq M. \quad (3.6)$$

Naturally, (3.5), (3.6) describe the respective m -dimensional smooth geometry with $M - m$ permutable transformations.

Throughout this section, a *smooth* function $g : \mathcal{D} \rightarrow \mathcal{X}$ is one that is infinitely often differentiable on its domain, $g \in C^\infty(\mathcal{D})$. For a compact set $\mathcal{K} \subset \mathcal{D}$, we say that a sequence of smooth functions g^ϵ converges toward a smooth function g with the order $\mathcal{O}(\epsilon)$ in $C^\infty(\mathcal{K})$, if

$$\|g^\epsilon - g\|_{C^\ell(\mathcal{K})} \leq c_\ell \epsilon$$

with suitable constants c_ℓ for any $\ell \in \mathbb{N}$. Convergence in $C^\infty(\mathcal{D})$ means convergence in $C^\infty(\mathcal{K})$ for all compact sets $\mathcal{K} \subset \mathcal{D}$.

Convergence of discrete functions (defined on lattices \mathcal{B}^ϵ with different ϵ) is understood as follows. We say that a family of discrete functions $x^\epsilon : \mathcal{B}^\epsilon \rightarrow \mathcal{X}$ converges to a function $x : \mathcal{B} \rightarrow \mathcal{X}$ with the order $\mathcal{O}(\epsilon)$ in $C^\infty(\mathcal{B})$, if for any multi-index $\alpha = (\alpha_1, \dots, \alpha_M)$ there holds

$$\sup_{u \in \mathcal{B}^\epsilon} |\delta^\alpha(x^\epsilon - x)(u)| \leq c_\alpha \epsilon$$

with some constants c_α . The symbol x on the left-hand side is understood as a restriction of x to $\mathcal{B}^\epsilon \subset \mathcal{B}$.

Finally, we mention that we are mainly concerned with *local* problems, so that actually we work with bounded domains of the lattices \mathcal{B}^ϵ ,

$$\mathcal{B}^\epsilon(r) = \{u \in \mathcal{B}^\epsilon : u_i \in [0, r], \quad u_j \in \{0, 1\}, \quad 1 \leq i \leq m < j \leq M\}.$$

Each $\mathcal{B}^\epsilon(r)$ contains only finitely many points (though their number grows infinitely with $\epsilon \rightarrow 0$, if r remains fixed). For functions u^ϵ defined on a bounded lattice domain $\mathcal{B}^\epsilon(r)$ only, the notion of convergence is modified in an obvious way: the supremum is taken only over those lattice sites u , where the respective difference quotient $\delta^\alpha x^\epsilon(u)$ exists.

Theorem 3.6 *Consider a Goursat problem (3.1), (3.2) for a hyperbolic system of difference equations. Suppose that:*

- i) the discrete system (3.1) is consistent for all $\epsilon > 0$;*
- ii) functions $g_{k,i}^\epsilon$ on the right-hand sides of eqs. (3.1) converge with the order $\mathcal{O}(\epsilon)$ in $C^\infty(\mathcal{X}_k)$ to smooth functions $g_{k,i}^0$;*
- iii) the Goursat data X_k^ϵ converge with the order $\mathcal{O}(\epsilon)$ in $C^\infty(\mathcal{B}_{S(k)})$ to smooth functions X_k^0 .*

Then, for $\epsilon > 0$ small enough, solution x^ϵ of the Goursat problem exists and is unique on $\mathcal{B}^\epsilon(r)$ for a suitable (ϵ -independent) $r > 0$; moreover, solutions x^ϵ converge to a smooth function x^0 with the order $\mathcal{O}(\epsilon)$ in $C^\infty(\mathcal{B}(r))$; this function x^0 is a unique solution on $\mathcal{B}(r)$ of the Goursat problem for (3.5), (3.6) with the Goursat data X_k^0 .

Proof of this theorem is technical, based on the discrete Gronwall-type estimates. Details can be found in [BobMaS1]. \square

In condition *ii*), convergence $g_{k,i}^\epsilon \rightarrow g_{k,i}^0$ in $C^\infty(\mathcal{X}_k)$, i.e., on every compact subset of \mathcal{X}_k , is assumed for simplicity of presentation only. In applications, functions $g_{k,i}^\epsilon$ are often defined on certain subdomains $\mathcal{D}_k^\epsilon \subset \mathcal{X}_k$, with the property that \mathcal{D}_k^0 is open and dense in \mathcal{X}_k . In such a case, one requires in *ii*) the convergence $g_{k,i}^\epsilon \rightarrow g_{k,i}^0$ in $C^\infty(\mathcal{D}^0)$. Then conclusions of Theorem 3.6 hold for generic initial data.

As for condition *iii*), smooth data $X_k^0 : \mathcal{B}_{\mathcal{S}_k} \rightarrow \mathcal{X}_k$ are usually given a priori, and discrete data X_k^ϵ are obtained by restriction to the lattice: $X_k^\epsilon = X_k^0 \upharpoonright_{\mathcal{B}_{\mathcal{S}_k}^\epsilon}$. In such a situation, condition *iii*) is fulfilled automatically.

3.3 Conjugate nets

Discretization of a conjugate net. Recall that a smooth conjugate net $f : \mathbb{R}^m \rightarrow \mathbb{R}^N$ is determined by the initial data (Q_{1,2}) (see Sect. 1.1), while a discrete Q-net $f^\epsilon : (\epsilon\mathbb{Z})^m \rightarrow \mathbb{R}^N$ is determined by the initial data (Q_{1,2}^Δ) (see Sect. 2.1). We now demonstrate how to produce from the data (Q_{1,2}) certain discrete data (Q_{1,2}^Δ), which will assure the convergence of the corresponding discrete Q-nets to the smooth conjugate net.

Define the discrete curves $f^\epsilon \upharpoonright_{\mathcal{B}_i^\epsilon}$ by restricting the curves $f \upharpoonright_{\mathcal{B}_i}$ to the lattice points:

$$f^\epsilon(u) = f(u), \quad u \in \mathcal{B}_i^\epsilon, \quad 1 \leq i \leq m.$$

Similarly, define the plaquette functions $c_{ij}^\epsilon \upharpoonright_{\mathcal{B}_{ij}^\epsilon}$ by restricting $c_{ij} \upharpoonright_{\mathcal{B}_{ij}}$ to the lattice points:

$$c_{ij}^\epsilon(u) = c_{ij}(u), \quad u \in \mathcal{B}_{ij}^\epsilon, \quad 1 \leq i \neq j \leq m.$$

An even better option is to read off the values of $c_{ij} \upharpoonright_{\mathcal{B}_{ij}}$ at the middlepoints of the corresponding plaquettes of $\mathcal{B}_{ij}^\epsilon$:

$$c_{ij}^\epsilon(u) = c_{ij}(u + \frac{\epsilon}{2}e_i + \frac{\epsilon}{2}e_j), \quad u \in \mathcal{B}_{ij}^\epsilon, \quad 1 \leq i \neq j \leq m.$$

Either choice gives the data $(Q_{1,2}^\Delta)$ which define an ϵ -dependent family of discrete Q-nets $f^\epsilon : (\epsilon\mathbb{Z})^m \rightarrow \mathbb{R}^N$, called *canonical discrete Q-nets* corresponding to the initial data $(Q_{1,2})$.

Theorem 3.7 *For some $r > 0$, the canonical discrete Q-nets $f^\epsilon : \mathcal{B}^\epsilon(r) \rightarrow \mathbb{R}^N$ converge, as $\epsilon \rightarrow 0$, to the unique conjugate net $f : \mathcal{B}(r) \rightarrow \mathbb{R}^N$ with the initial data $(Q_{1,2})$. Convergence is with the order $\mathcal{O}(\epsilon)$ in $C^\infty(\mathcal{B}(r))$.*

This follows directly from Theorem 3.6, since eqs. (2.1), (2.2) and (1.1), (1.2) are manifestly hyperbolic (and can be easily re-written in the first order form).

Discretization of a Jonas pair. Recall that a Jonas transform of a given conjugate net is determined by the initial data $(J_{1,2})$ (see Sect. 1.1). We now produce out of these the initial data $(J_{1,2}^\Delta)$ (see Sect. 2.1) for an ϵ -dependent family of Jonas transforms of canonical discrete Q-nets corresponding to the initial data $(Q_{1,2})$.

Take the point $f^+(0)$ from (J_1) . Define the edge functions $a_i^\epsilon|_{\mathcal{B}_i^\epsilon}$, $b_i^\epsilon|_{\mathcal{B}_i^\epsilon}$ by restricting the functions $a_i|_{\mathcal{B}_i}$, $b_i|_{\mathcal{B}_i}$ to the lattice points, or, better, to the middlepoints of the corresponding edges of \mathcal{B}_i^ϵ . This gives the data set $(J_{1,2}^\Delta)$; along with the data $(Q_{1,2}^\Delta)$ produced above this yields in a canonical way an ϵ -dependent family of discrete Q-nets $F^\epsilon : (\epsilon\mathbb{Z})^m \times \{0, 1\} \rightarrow \mathbb{R}^N$, which will be called the canonical ones for the initial data $(Q_{1,2})$, $(J_{1,2})$.

Theorem 3.8 *The canonical Q-nets $(f^\epsilon)^+ = F^\epsilon(\cdot, 1) : \mathcal{B}^\epsilon(r) \rightarrow \mathbb{R}^N$ converge to the unique Jonas transform $f^+ : \mathcal{B}(r) \rightarrow \mathbb{R}^N$ of f with the initial data $(J_{1,2})$. Convergence is with the order $\mathcal{O}(\epsilon)$ in $C^\infty(\mathcal{B}(r))$.*

Again, this follows directly from Theorem 3.6, applied to the hyperbolic systems consisting of eqs. (2.13)–(2.15) in the discrete case and of eqs. (1.11)–(1.13) in the smooth case. Note that the discrete equations are implicit, and their solvability for ϵ small enough is guaranteed on the set $\{a_j \neq 0 : 1 \leq j \leq m\}$, which is open dense in the phase space.

3.4 Orthogonal nets

We start with approximation of a single orthogonal net $f : \mathbb{R}^m \rightarrow \mathbb{R}^N$. For the approximating discrete O-nets, we have $M = m$ and all $\epsilon_i = \epsilon$. In all formulas of Sect. 2.2 one has to replace the lattice functions h_i , β_{ij} , ρ_{kj} by

ϵh_i , $\epsilon \beta_{ij}$, $\epsilon \rho_{kj}$, respectively. Observe that formulas (2.29), (2.37) become

$$\begin{aligned}\nu_{ji} &= \nu_{ij} = (1 - \epsilon^2 \beta_{ij} \beta_{ji})^{1/2} = 1 + \mathcal{O}(\epsilon^2), \\ \sigma_i &= \left(1 - \frac{\epsilon^2}{4} \sum_{k \neq i} \rho_{ki}^2\right)^{1/2} = 1 + \mathcal{O}(\epsilon^2).\end{aligned}$$

Under this re-scaling, eqs. (2.25), (2.26), (2.27) and (2.30) can be put into the standard form (3.1) with the functions on the right-hand sides approximating, as $\epsilon \rightarrow 0$, the corresponding functions in eqs. (1.6)–(1.9) with the order $\mathcal{O}(\epsilon)$.

Nevertheless, formally speaking, Theorem 3.6 cannot be applied to orthogonal nets. The reason for this is that the full system of differential equations describing orthogonal nets, consisting of eqs. (1.6)–(1.9) and the constraint (1.35), is non-hyperbolic. Its non-hyperbolicity rests on the fact that the constraint (1.35) is not resolved with respect to the derivatives $\partial_i \beta_{ij}$. Note, however, that constraint (1.35) does not take part in the evolution of solutions starting with the data given in the coordinate planes \mathcal{B}_{ij} : it is satisfied automatically, provided it is fulfilled for the coordinate surfaces $f|_{\mathcal{B}_{ij}}$. Therefore, we will obtain a convergence result for orthogonal nets as soon as it will be established for coordinate surfaces.

Discretization of an O-surface. Initial data for a smooth O-surface $f : \mathcal{B}_{12} \rightarrow \mathbb{R}^N$ are:

- (i) two smooth curves $f|_{\mathcal{B}_i}$ ($i = 1, 2$), intersecting orthogonally at $f(0)$;
- (ii) a smooth function $\gamma_{12} : \mathcal{B}_{12} \rightarrow \mathbb{R}$, whose designated meaning is $\gamma_{12} = \frac{1}{2}(\partial_1 \beta_{12} - \partial_2 \beta_{21})$.

Let $\hat{f}|_{\mathcal{B}_i}$ be the images of the curves $f|_{\mathcal{B}_i}$ in the Möbius-geometric model \mathbb{Q}_0^N . Let $h_i = |\partial_i \hat{f}|$ and $\hat{v}_i = h_i^{-1} \partial_i \hat{f}$ be the metric coefficients and unit tangent vectors of the coordinate curves. Choose an initial frame $\psi(0) \in \mathcal{H}_\infty$ such that

$$\hat{f}(0) = \psi^{-1}(0) \mathbf{e}_0 \psi(0), \quad \hat{v}_i(0) = \psi^{-1}(0) \mathbf{e}_i \psi(0) \quad (i = 1, 2).$$

Define the frames $\psi : \mathcal{B}_i \rightarrow \mathcal{H}_\infty$ of the curves $\hat{f}|_{\mathcal{B}_i}$ as the solutions of eqs. (1.32) for $i = 1, 2$ (considered as ordinary differential equations) with the initial value $\psi(0)$. *Rotation coefficients of the curves $\hat{f}|_{\mathcal{B}_i}$* are the functions $\beta_{ki} : \mathcal{B}_i \rightarrow \mathbb{R}$ defined by the formula (1.34) for $i = 1, 2$.

Define the discrete coordinate curves $\hat{f}^\epsilon|_{\mathcal{B}_i^\epsilon}$ by restricting the functions $\hat{f}|_{\mathcal{B}_i}$ to the lattice points. Let $h_i^\epsilon = |\delta_i \hat{f}^\epsilon|$ and $\hat{v}_i^\epsilon = (h_i^\epsilon)^{-1} \delta_i \hat{f}^\epsilon$ be the discrete metric coefficients and unit vectors along the discrete curves. Define

the frame $\psi^\epsilon : \mathcal{B}_i^\epsilon \rightarrow \mathcal{H}_\infty$ by iterating the difference equation (2.33) for $i = 1, 2$ with the initial condition $\psi^\epsilon(0) = \psi(0)$. Then *canonical rotation coefficients of the discrete curves* $\hat{f}^\epsilon|_{\mathcal{B}_i^\epsilon}$ are the coefficients $\rho_{ki}^\epsilon : \mathcal{B}_i^\epsilon \rightarrow \mathbb{R}$ in the expansions

$$V_i^\epsilon = \psi^\epsilon \hat{v}_i^\epsilon (\psi^\epsilon)^{-1} = \sigma_i^\epsilon \mathbf{e}_i - \frac{\epsilon}{2} \sum_{k \neq i} \rho_{ki}^\epsilon \mathbf{e}_k + \epsilon h_i^\epsilon \mathbf{e}_\infty.$$

Finally, let the plaquette function $\gamma_{12}^\epsilon : \mathcal{B}_{12}^\epsilon \rightarrow \mathbb{R}$ be obtained by restricting γ_{12} to the lattice points (or to the middlepoints of the corresponding plaquettes of $\mathcal{B}_{12}^\epsilon$).

Thus, we get valid Goursat data for a hyperbolic system of first-order difference equations for the variables $\hat{f}^\epsilon, \hat{v}_i^\epsilon, h_i^\epsilon, \rho_{ki}^\epsilon$, consisting of eqs. (2.25), (2.26), (2.27), (2.38) and (2.39) with distinct $i, j \in \{1, 2\}$ and $1 \leq k \leq N$, where the following expressions should be inserted:

$$\beta_{12}^\epsilon = \sigma_1^\epsilon \rho_{12}^\epsilon - \frac{\epsilon}{2} \left(\frac{1}{2} \sum_{k>2} \rho_{k1}^\epsilon \rho_{k2}^\epsilon - \gamma_{12}^\epsilon \right), \quad \beta_{21}^\epsilon = \sigma_2^\epsilon \rho_{21}^\epsilon - \frac{\epsilon}{2} \left(\frac{1}{2} \sum_{k>2} \rho_{k1}^\epsilon \rho_{k2}^\epsilon + \gamma_{12}^\epsilon \right).$$

The discrete nets $\hat{f}^\epsilon : \mathcal{B}_{12}^\epsilon \rightarrow \mathbb{Q}_0^N$ defined as solutions of the Goursat problem just described are discrete O-surfaces, since they fulfill the circularity constraint (2.40). They will be called *canonical discrete O-surfaces* constructed from the above initial data.

Theorem 3.9 *For some fixed $r > 0$, the canonical discrete O-surfaces $\hat{f}^\epsilon : \mathcal{B}_{12}^\epsilon(r) \rightarrow \mathbb{Q}_0^N$ converge, with the order $\mathcal{O}(\epsilon)$ in $C^\infty(\mathcal{B}_{12}(r))$, to the unique O-surface $f : \mathcal{B}_{12}(r) \rightarrow \mathbb{Q}_0^N$ with the initial data $f|_{\mathcal{B}_i}$ ($i = 1, 2$) and $\frac{1}{2}(\partial_1 \beta_{12} - \partial_2 \beta_{21}) = \gamma_{12}$. Edge rotation coefficients ρ_{ki}^ϵ and plaquette rotation coefficients $\beta_{12}^\epsilon, \beta_{21}^\epsilon$ of the discrete O-surfaces \hat{f}^ϵ converge to the corresponding rotation coefficients β_{ki} of the O-surface f .*

Proof. First, we show the convergence of the frames, $\psi^\epsilon \rightarrow \psi$, and of the rotation coefficients, $\rho_{ki}^\epsilon \rightarrow \beta_{ki}$, along the discrete curves $\hat{f}^\epsilon|_{\mathcal{B}_i^\epsilon}$. This follows from two observations. First, $\hat{v}_i^\epsilon(0) = \hat{v}_i(0) + \frac{\epsilon}{2}(\partial_i \hat{v}_i)(0) + \mathcal{O}(\epsilon^2)$, so that there holds:

$$(\tau_i - 1)\psi^\epsilon(0) = -\frac{\epsilon}{2} \mathbf{e}_i \psi(0) (\partial_i \hat{v}_i)(0) + \mathcal{O}(\epsilon^2).$$

Second, combining frame equations on two neighboring edges of \mathcal{B}_i^ϵ , one finds that everywhere on \mathcal{B}_i^ϵ there holds:

$$(\tau_i - \tau_i^{-1})\psi^\epsilon = -\mathbf{e}_i \psi^\epsilon (1 - \tau_i^{-1}) \hat{v}_i^\epsilon = -\epsilon \mathbf{e}_i \psi^\epsilon (\partial_i \hat{v}_i) + \mathcal{O}(\epsilon^2).$$

The claim follows by standard methods of the ODE theory.

Now an application of Theorem 3.6 shows that functions $\hat{f}^\epsilon : \mathcal{B}_{12}^\epsilon \rightarrow \mathbb{Q}_0^N$ converge to the functions $\hat{f} : \mathcal{B}_{12} \rightarrow \mathbb{Q}_0^N$ which solve the Goursat problem for the hyperbolic system of first order differential equations, consisting of eqs. (1.6)–(1.9) with distinct $i, j \in \{1, 2\}$ and $1 \leq k \leq N$, and

$$\partial_1 \beta_{12} = -\frac{1}{2} \sum_{k>2} \beta_{k1} \beta_{k2} + \gamma_{12}, \quad \partial_2 \beta_{21} = -\frac{1}{2} \sum_{k>2} \beta_{k1} \beta_{k2} - \gamma_{12}.$$

The solutions β_{ki} satisfy the orthogonality constraint (1.24) and the relation $\frac{1}{2}(\partial_1 \beta_{12} - \partial_2 \beta_{21}) = \gamma_{12}$. \square

Discretization of an m -dimensional orthogonal net. Given the initial data $(O_{1,2})$ for an m -dimensional orthogonal net (see Sect. 1.2), we can apply the procedure described in the previous paragraph, with an initial frame $\psi(0) \in \mathcal{H}_\infty$ such that

$$\hat{f}(0) = \psi^{-1}(0) \mathbf{e}_0 \psi(0), \quad \hat{v}_i(0) = \psi^{-1}(0) \mathbf{e}_i \psi(0) \quad (1 \leq i \leq m),$$

to produce, in a canonical way, the discrete O-surfaces $\hat{f}^\epsilon \upharpoonright_{\mathcal{B}_{ij}^\epsilon}$ and their plaquette rotation coefficients β_{ij}^ϵ . Thus, we get data $(O_{1,2}^\Delta)$ (see Sect. 2.2) for an ϵ -dependent family of discrete O-nets $\hat{f}^\epsilon : (\epsilon\mathbb{Z})^m \rightarrow \mathbb{Q}_0^N$. These nets will be called the *canonical discrete O-nets* corresponding to the initial data $(O_{1,2})$.

Theorem 3.10 *The canonical discrete O-nets $\hat{f}^\epsilon : \mathcal{B}^\epsilon(r) \rightarrow \mathbb{R}^N$ converge, as $\epsilon \rightarrow 0$, to the unique orthogonal net $\hat{f} : \mathcal{B}(r) \rightarrow \mathbb{R}^N$ with the initial data $(O_{1,2})$. Convergence is with the order $\mathcal{O}(\epsilon)$ in $C^\infty(\mathcal{B}(r))$.*

Proof. The data $(O_{1,2}^\Delta)$ yield a well-posed Goursat problem for the hyperbolic system of first-order difference equations for the variables \hat{f}^ϵ , \hat{v}_i^ϵ , h_i^ϵ , β_{ij}^ϵ , consisting of eqs. (2.25), (2.26), (2.27), (2.30). The convergence of these Goursat data is assured by Theorem 3.9. Now the claim of the theorem follows directly from Theorem 3.6. \square

Discretization of a Ribaucour pair. Given the initial data $(R_{1,2})$ for a Ribaucour transform of an orthogonal net (see Sect. 1.2), define the plaquette rotation coefficients β_{Mi}^ϵ on the “vertical” plaquettes along the edges of the coordinate axes \mathcal{B}_i^ϵ by restricting the corresponding functions $\epsilon\theta_i$ to lattice points or, alternatively, to middlepoints of the corresponding edges of \mathcal{B}_i^ϵ :

$$\beta_{Mi}^\epsilon(u) = \epsilon\theta_i(u) \text{ or } \epsilon\theta_i(u + \frac{\epsilon}{2}), \quad u \in \mathcal{B}_i^\epsilon, \quad 1 \leq i \leq m.$$

Thus, we get the data $(R_{1,2}^\Delta)$ (see Sect. 2.2), which, together with $(O_{1,2}^\Delta)$, allow us to construct in a canonical way discrete O-nets $F^\epsilon : (\epsilon\mathbb{Z})^m \times \{0, 1\} \rightarrow \mathbb{R}^N$. They will be called the canonical ones corresponding to the initial data $(O_{1,2})$, $(R_{1,2})$.

Theorem 3.11 *The canonical discrete O-nets $(f^\epsilon)^+ = F^\epsilon(\cdot, 1) : \mathcal{B}^\epsilon(r) \rightarrow \mathbb{R}^N$ converge to the unique Ribaucour transform $f^+ : \mathcal{B}(r) \rightarrow \mathbb{R}^N$ of f with the initial data $(R_{1,2})$. Convergence is with the order $\mathcal{O}(\epsilon)$ in $C^\infty(\mathcal{B}(r))$.*

Proof. Define $v_M^\epsilon(0)$ as the unit vector parallel to $\delta f(0) = f^+(0) - f(0)$, and set $h_M^\epsilon(0) = |\delta f(0)|$. These data along with β_{Mi}^ϵ on the coordinate axes, added to the previously found ones $f^\epsilon(0)$, v_i^ϵ , h_i^ϵ , β_{ij}^ϵ for $1 \leq i, j \leq m$, form valid Goursat data for the system (2.25), (2.26), (2.27), (2.30).

The circularity constraint (2.28) implies that $\beta_{iM}^\epsilon = -2\langle v_i^\epsilon, v_M^\epsilon \rangle - \epsilon\theta_i$ on all edges of \mathcal{B}_i^ϵ . Perform the substitution

$$v_M^\epsilon = y + \mathcal{O}(\epsilon), \quad h_M^\epsilon = \ell + \mathcal{O}(\epsilon), \quad \beta_{Mi}^\epsilon = \epsilon\theta_i + \mathcal{O}(\epsilon^2), \quad \beta_{iM}^\epsilon = -2\langle v_i, y \rangle + \mathcal{O}(\epsilon)$$

in eqs. (2.26), (2.27), (2.30) with one of the indices equal to M . Taking into account that in this limit one has

$$\nu_{iM}^{-1} = \nu_{Mi}^{-1} = 1 - \epsilon\langle v_i, y \rangle\theta_i + \mathcal{O}(\epsilon^2),$$

one sees that the limiting equations coincide with eqs. (1.26), (1.27), (1.28). A reference to Theorem 3.6 finishes the proof. \square

3.5 Moutard nets

Discretization of an M-net. Given the initial data $(M_{1,2})$ for an M-net (see Sect. 1.3), we produce initial data $(M_{1,2}^\Delta)$ for an ϵ -dependent family of discrete M-nets with $\epsilon_1 = \epsilon_2 = \epsilon$. Discrete curves $f^\epsilon|_{\mathcal{B}_i^\epsilon}$ are obtained from the smooth curves $f|_{\mathcal{B}_i}$ by restricting to the lattice points:

$$f^\epsilon(u) = f(u), \quad u \in \mathcal{B}_i^\epsilon, \quad i = 1, 2.$$

The plaquette function $a_{12}^\epsilon : (\epsilon\mathbb{Z})^2 \rightarrow \mathbb{R}$ is obtained from the function q_{12} restricted to the lattice points:

$$a_{12}^\epsilon(u) = 1 + \frac{1}{2}\epsilon^2 q_{12}(u), \quad u \in (\epsilon\mathbb{Z})^2$$

(one could also restrict q_{12} to middlepoints of the corresponding plaquettes). Now discrete M-nets $f^\epsilon : (\epsilon\mathbb{Z})^2 \rightarrow \mathbb{R}^N$ are defined as solutions of the difference equation (2.41) with the above data $(M_{1,2}^\Delta)$.

Theorem 3.12 *Canonical discrete M-nets $f^\epsilon : \mathcal{B}^\epsilon(r) \rightarrow \mathbb{R}^N$ converge, as $\epsilon \rightarrow 0$, to the unique M-net $f : \mathcal{B}(r) \rightarrow \mathbb{R}^N$ with the initial data $(M_{1,2})$. Convergence is with the order $\mathcal{O}(\epsilon)$ in $C^\infty(\mathcal{B}(r))$.*

Proof. Eq. (2.41) is manifestly hyperbolic (and can be easily put in the first order form). It approximates eq. (1.36), because it can be re-written as

$$\delta_1 \delta_2 f = \frac{1}{2} q_{12} (\tau_1 f + \tau_2 f) = q_{12} (f + \frac{\epsilon}{2} \delta_1 f + \frac{\epsilon}{2} \delta_2 f).$$

Now Theorem 3.6 can be applied. \square

Discretization of a Moutard pair. Let the initial data $(MT_{1,2})$ for a Moutard transformation be given. Define the edge variables $b_i^\epsilon \upharpoonright_{\mathcal{B}_i^\epsilon}$ from the functions $p_i \upharpoonright_{\mathcal{B}_i}$ restricted to the lattice points:

$$b_1^\epsilon(u_1, 0) = 1 + \epsilon p_1(u_1, 0), \quad b_2^\epsilon(0, u_2) = 1 + \epsilon p_2(0, u_2), \quad u_i \in \epsilon \mathbb{Z}$$

(one could restrict $p_i \upharpoonright_{\mathcal{B}_i}$ to the middlepoints of the corresponding edges, as well). This gives us the data $(MT_{1,2}^\Delta)$, which canonically generate discrete M-nets $(f^\epsilon)^+ : (\epsilon \mathbb{Z})^2 \rightarrow \mathbb{R}^N$.

Theorem 3.13 *Canonical discrete M-nets $(f^\epsilon)^+ : \mathcal{B}^\epsilon(r) \rightarrow \mathbb{R}^N$ converge to the unique Moutard transform $f^+ : \mathcal{B}(r) \rightarrow \mathbb{R}^N$ of f with the initial data $(MT_{1,2})$. Convergence is with the order $\mathcal{O}(\epsilon)$ in $C^\infty(\mathcal{B}(r))$.*

Proof. The system consisting of eqs. (2.45), (2.46) is hyperbolic. Upon substituting $b_i = 1 + \epsilon p_i$ and $a_{12} = 1 + \frac{1}{2} \epsilon^2 q_{12}$, these equations can be re-written as

$$\delta_1 f^+ + \delta_1 f = p_1(f^+ - \tau_1 f), \quad \delta_2 f^+ - \delta_2 f = p_2(f^+ + \tau_2 f),$$

and

$$\frac{1 + \epsilon \tau_2 p_1}{1 + \epsilon p_1} = \frac{1 + \epsilon \tau_1 p_2}{1 + \epsilon p_2} = \frac{1 + (\epsilon^2/2) q_{12}^+}{1 + (\epsilon^2/2) q_{12}} = \frac{1}{1 + \epsilon^2 (q_{12} - p_1 p_2) + \mathcal{O}(\epsilon^3)}.$$

Clearly, they approximate, as $\epsilon \rightarrow 0$, eqs. (1.37)–(1.38) and (1.39)–(1.40), respectively. It remains to apply Theorem 3.6. \square

3.6 A-surfaces

Discretization of an A-surface. Initial data $(A_{1,2})$ for an A-surface (see Sect. 1.4), are nothing but initial data $(M_{1,2})$ for the Lelievre normal field

$n : \mathbb{R}^2 \rightarrow \mathbb{R}^3$. In Theorem 3.12, we described the canonical construction of the initial data $(A_{1,2}^\Delta)$, which give a converging family of the discrete Lelievre normal fields $n^\epsilon : (\epsilon\mathbb{Z})^2 \rightarrow \mathbb{R}^3$. Eqs. (2.53) define the discrete A-surfaces $f^\epsilon : (\epsilon\mathbb{Z})^2 \rightarrow \mathbb{R}^3$, called the *canonical discrete A-surfaces* corresponding to the initial data $(A_{1,2})$.

Theorem 3.14 *Canonical discrete A-surfaces $f^\epsilon : \mathcal{B}^\epsilon(r) \rightarrow \mathbb{R}^3$ converge, as $\epsilon \rightarrow 0$, to the unique A-surface $f : \mathcal{B}(r) \rightarrow \mathbb{R}^3$ with the initial data $(A_{1,2})$. Convergence is with the order $\mathcal{O}(\epsilon)$ in $C^\infty(\mathcal{B}(r))$.*

Proof. Eqs. (2.53) are hyperbolic and approximate eqs. (1.43). Theorem 3.6 can be applied to prove the convergence of f^ϵ , after the convergence of n^ϵ has been already proved. \square

Discretization of a Weingarten pair. Initial data $(W_{1,2})$ for a Weingarten transformation are nothing but initial data $(MT_{1,2})$ for a Moutard transformation of the Lelievre normal field. We already described, in Theorem 3.13, the canonical construction of the initial data $(W_{1,2}^\Delta)$ for a converging family of the discrete Lelievre normal fields $(n^\epsilon)^+ : (\epsilon\mathbb{Z})^2 \rightarrow \mathbb{R}^3$. Now the transformed A-surfaces $(f^\epsilon)^+ : (\epsilon\mathbb{Z})^2 \rightarrow \mathbb{R}^3$ are obtained by eq. (2.51).

Theorem 3.15 *Canonical discrete A-nets $(f^\epsilon)^+ : \mathcal{B}^\epsilon(r) \rightarrow \mathbb{R}^3$ converge to the unique Weingarten transform $f^+ : \mathcal{B}(r) \rightarrow \mathbb{R}^3$ of f with the initial data $(W_{1,2})$. Convergence is with the order $\mathcal{O}(\epsilon)$ in $C^\infty(\mathcal{B}(r))$.*

Proof follows by comparing the (identical) formulas (1.45) and (2.51), after the convergence of n^ϵ and $(n^\epsilon)^+$ has been proved. \square

3.7 K-surfaces

Discretization of a K-surface. Given the initial data (K) for a K-surface (see Sect. 1.5), we define initial data (K^Δ) (see Sect. 2.5) for an ϵ -dependent family of discrete K-surfaces with $\epsilon_1 = \epsilon_2 = \epsilon$ by restricting $n|_{\mathcal{B}_i}$ to the lattice points, as for general A-surfaces. Define discrete M-nets $n^\epsilon : (\epsilon\mathbb{Z})^2 \rightarrow \mathbb{S}^2$ as solutions of the difference equations (2.56) with the initial data (K^Δ) . Finally, define the discrete K-surfaces $f^\epsilon : (\epsilon\mathbb{Z})^2 \rightarrow \mathbb{R}^3$ with the help of the discrete Lelievre representation (2.53). These will be called the *canonical discrete K-surfaces* corresponding to the initial data (K) .

Theorem 3.16 *Canonical discrete K-surfaces $f^\epsilon : \mathcal{B}^\epsilon(r) \rightarrow \mathbb{R}^3$ converge, as $\epsilon \rightarrow 0$, to the unique K-surface $f : \mathcal{B}(r) \rightarrow \mathbb{R}^3$ with the initial data (K) . Convergence is with the order $\mathcal{O}(\epsilon)$ in $C^\infty(\mathcal{B}(r))$.*

Proof. We have for $n = n^\epsilon$:

$$a_{12}^\epsilon = \frac{\langle n, \tau_1 n + \tau_2 n \rangle}{1 + \langle \tau_1 n, \tau_2 n \rangle} = \frac{2 + \epsilon \langle n, \delta_1 n + \delta_2 n \rangle}{2 + \epsilon \langle n, \delta_1 n + \delta_2 n \rangle + \epsilon^2 \langle \delta_1 n, \delta_2 n \rangle}.$$

Since $\langle n, \delta_i n \rangle = \mathcal{O}(\epsilon)$, we find that

$$a_{12}^\epsilon = 1 - \frac{1}{2}\epsilon^2 \langle \delta_1 n, \delta_2 n \rangle + \mathcal{O}(\epsilon^4).$$

Comparing this with eq. (1.48), we see that Theorem 3.6 can be applied in order to prove approximation of $n : \mathbb{R}^2 \rightarrow \mathbb{S}^2$ by $n^\epsilon : (\epsilon\mathbb{Z})^2 \rightarrow \mathbb{S}^2$. Finally, approximation of f by f^ϵ follows exactly as for general A-surfaces. \square

Discretization of a Bäcklund pair. Let the initial data (B) for a Bäcklund transformation of a given K-surface f , i.e. the point $n^+(0)$, be given. Take it as the initial data (B $^\Delta$) for the discrete Bäcklund transformations $(f^\epsilon)^+ : (\epsilon\mathbb{Z})^2 \rightarrow \mathbb{R}^3$ of the family f^ϵ of discrete K-surfaces constructed in Theorem 3.16.

Theorem 3.17 *Canonical discrete K-surfaces $(f^\epsilon)^+ : \mathcal{B}^\epsilon(r) \rightarrow \mathbb{R}^3$ converge to the unique Bäcklund transform $f^+ : \mathcal{B}(r) \rightarrow \mathbb{R}^3$ of f with the initial data (B). Convergence is with the order $\mathcal{O}(\epsilon)$ in $C^\infty(\mathcal{B}(r))$.*

Proof. In eqs. (2.57), (2.58) we have:

$$\begin{aligned} b_1 &= \frac{\langle n, \tau_1 n - n^+ \rangle}{1 - \langle \tau_1 n, n^+ \rangle} = 1 + \epsilon \frac{\langle \delta_1 n, n^+ \rangle}{1 - \langle n, n^+ \rangle} + \mathcal{O}(\epsilon^2), \\ b_2 &= \frac{\langle n, \tau_2 n + n^+ \rangle}{1 + \langle \tau_2 n, n^+ \rangle} = 1 - \epsilon \frac{\langle \delta_2 n, n^+ \rangle}{1 + \langle n, n^+ \rangle} + \mathcal{O}(\epsilon^2). \end{aligned}$$

Comparing this with eqs. (1.46)–(1.47) and applying Theorem 3.6, we prove approximation of the Gauss maps. \square

Chapter 4

Consistency as integrability

4.1 From 3D consistency of discrete 2D systems to Bäcklund transformations and zero curvature representations

Equations of a discrete 2D hyperbolic system are associated to elementary squares of \mathbb{Z}^2 . Such a system may contain fields on vertices and/or on edges of \mathbb{Z}^2 . In our differential-geometric considerations we encountered two types of such systems: the cross-ratio system, with fields on the vertices and the parameters on the edges of \mathbb{Z}^2 , and discrete Lorentz-harmonic maps into quadrics, with fields on the vertices of \mathbb{Z}^2 . One can imagine further types of discrete hyperbolic 2D systems, for instance, those with fields on edges only. We will mainly consider systems of the cross-ratio type, and will discuss other types briefly.

2D systems with fields on vertices and with labelled edges. A typical representative of this class of equations is the cross-ratio system:

$$q(f, f_1, f_{12}, f_2) = \frac{\alpha_1}{\alpha_2}. \quad (4.1)$$

The variables $f : \mathbb{Z}^2 \rightarrow \mathcal{C}l(\mathbb{R}^N)$ are associated to the vertices of \mathbb{Z}^2 , while the variables $\alpha_i : \mathbb{Z}^2 \rightarrow \mathbb{R}$ satisfy the labelling property

$$\delta_2 \alpha_1 = 0, \quad \delta_1 \alpha_2 = 0. \quad (4.2)$$

Therefore α_i play the role of parameters naturally associated to edges of \mathbb{Z}^2 parallel to \mathcal{B}_i and constant along the strips in the complementary direction. (As a disclaimer, we mention that further edge variables have to be

introduced in order to put this equation in the first-order form.) One more example of such a system with vertex variables and parameters sitting on edges and having the labelling property is given by the *Hirota equation*,

$$\frac{f_{12}}{f} = \frac{\alpha_1 f_1 - \alpha_2 f_2}{\alpha_2 f_1 - \alpha_1 f_2}, \quad (4.3)$$

see [BobP1, BobMaS1] for the geometric interpretation of this system in terms of discrete K-surfaces. A general system of this class consists of equations

$$Q(f, f_1, f_{12}, f_2; \alpha_1, \alpha_2) = 0, \quad (4.4)$$

see Fig. 4.1. In the simplest situation one has complex fields $f : \mathbb{Z}^2 \rightarrow \mathbb{C}$, and complex parameters α_i on the edges of \mathbb{Z}^2 parallel to \mathcal{B}_i , satisfying the labelling condition (4.2). We require that eq. (4.4) be uniquely solvable for any one of its arguments $f, f_1, f_2, f_{12} \in \widehat{\mathbb{C}}$. Therefore, the solutions have to be fractional-linear in each of their arguments. This naturally leads to the following assumption.

Linearity. The function $Q(x, u, y, v; \alpha, \beta)$ is a polynomial of degree 1 in each argument (affine linear):

$$Q(x, u, y, v; \alpha, \beta) = a_1(\alpha, \beta)xuyv + \cdots + a_{16}(\alpha, \beta).$$

Note that for the cross-ratio equation (4.1) with complex-valued arguments, $Q = \beta(x - u)(y - v) - \alpha(u - y)(v - x)$, while for the Hirota equation (4.3), $Q = \alpha(xu + yv) - \beta(xv + yu)$.

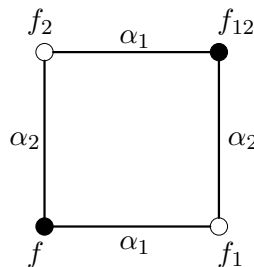

Figure 4.1: Elementary quadrilateral; fields on vertices

Actually, this setup admits an important generalization: elementary quadrilaterals carrying eqs. (4.4) can be attached one to another with the combinatorics more complicated than that of \mathbb{Z}^2 .

Definition 4.1 A quad-graph \mathcal{D} is a strongly regular polytopal cell decomposition of a surface with all quadrilateral faces.

We denote by $V(\mathcal{D})$, $E(\mathcal{D})$, $F(\mathcal{D})$ the sets of vertices, of edges and of faces of \mathcal{D} , respectively. We consider eq. (4.4) for fields $f : V(\mathcal{D}) \rightarrow \mathbb{C}$, with $\alpha : E(\mathcal{D}) \rightarrow \mathbb{C}$ being a labelling of edges of \mathcal{D} , i.e., a function taking equal values on any pair of opposite edges of any quadrilateral from $F(\mathcal{D})$. In the context of equations on quad-graphs, there are no distinguished coordinate directions, nevertheless it will be convenient to continue to use notations of eq. (4.4), with the understanding that indices are used locally (within one quadrilateral), and do not stand for shifts into the globally defined coordinate directions. So, f, f_1, f_2, f_3 can be *any* cyclic enumeration of the vertices of an elementary quadrilateral. Eq. (4.4) should not depend on the enumeration of vertices, therefore the following assumption is natural when considering equations on general quad-graphs.

Symmetry. The function Q has the symmetry properties

$$Q(x, u, y, v; \alpha, \beta) = \epsilon Q(x, v, y, u; \beta, \alpha) = \sigma Q(u, y, v, x; \beta, \alpha), \quad \epsilon, \sigma = \pm 1.$$

(For the complex cross-ratio equation and for the Hirota equation the functions Q given above possess this property with $\epsilon = \sigma = -1$).

Assume now that eq. (4.4) possesses the property of **3D consistency**. Recall that this means that this equation can be consistently imposed on all 2D faces of a combinatorial cube on Fig. 4.2, with the parallel edges of the i -th direction all carrying the parameter α_i . More precisely, given the initial data f, f_i , one determines f_{ij} in virtue of eq. (4.4), and then three equations for f_{123} (for three faces adjacent to this vertex) lead to identical results. This is the case for the complex cross-ratio equation, with

$$f_{123} = \frac{(\alpha_1 - \alpha_2)f_1f_2 + (\alpha_2 - \alpha_3)f_2f_3 + (\alpha_3 - \alpha_1)f_3f_1}{(\alpha_2 - \alpha_1)f_3 + (\alpha_3 - \alpha_2)f_1 + (\alpha_1 - \alpha_3)f_2}, \quad (4.5)$$

as well as for the Hirota equation, with

$$f_{123} = \frac{\alpha_3(\alpha_1^2 - \alpha_2^2)f_1f_2 + \alpha_1(\alpha_2^2 - \alpha_3^2)f_2f_3 + \alpha_2(\alpha_3^2 - \alpha_1^2)f_3f_1}{\alpha_3(\alpha_2^2 - \alpha_1^2)f_3 + \alpha_1(\alpha_3^2 - \alpha_2^2)f_1 + \alpha_2(\alpha_1^2 - \alpha_3^2)f_2}. \quad (4.6)$$

We will demonstrate that this condition automatically leads to two basic structures associated in the soliton theory with **integrability**: Bäcklund transformations and zero curvature representation.

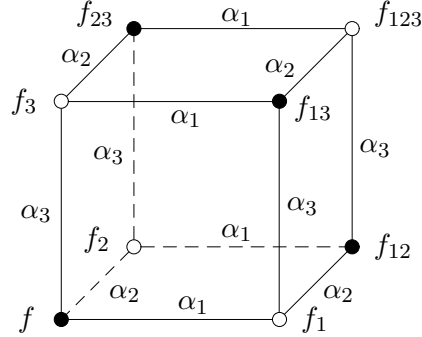

Figure 4.2: 3D consistency of 2D systems

Theorem 4.2 For any solution $f : V(\mathcal{D}) \rightarrow \mathbb{C}$ of a 3D consistent equation (4.4) on the quad-graph \mathcal{D} , there is a two-parameter family of solutions $f^+ : V(\mathcal{D}) \rightarrow \mathbb{C}$ of the same equation, satisfying

$$Q(f, f_i, f_i^+, f^+; \alpha_i, \lambda) = 0 \quad (4.7)$$

for all edges $(f, f_i) \in E(\mathcal{D})$. Such a solution f^+ is called a **Bäcklund transform** of f , and is determined by its value at one vertex of \mathcal{D} and by the parameter λ .

Proof. Extend the planar quad-graph \mathcal{D} into the third dimension. Formally speaking, we consider the second copy \mathcal{D}^+ of \mathcal{D} and add edges connecting each vertex $f \in V(\mathcal{D})$ with its copy $f^+ \in V(\mathcal{D}^+)$. (We slightly abuse the notations here, by using the same letter f for vertices of the quad-graph and for the fields assigned to these vertices.) On this way we obtain a “3D quad-graph” \mathbf{D} , with the set of vertices

$$V(\mathbf{D}) = V(\mathcal{D}) \cup V(\mathcal{D}^+),$$

with the set of edges

$$E(\mathbf{D}) = E(\mathcal{D}) \sqcup E(\mathcal{D}^+) \sqcup \{(f, f^+) : f \in V(\mathcal{D})\},$$

and with the set of faces

$$F(\mathbf{D}) = F(\mathcal{D}) \sqcup F(\mathcal{D}^+) \sqcup \{(f, f_1, f_1^+, f^+) : f, f_1 \in V(\mathcal{D})\}.$$

Elementary building blocks of \mathbf{D} are combinatorial cubes $(f, f_1, f_{12}, f_2, f^+, f_1^+, f_{12}^+, f_2^+)$, as shown on Fig. 4.3. The labelling on $E(\mathbf{D})$ is defined

in the natural way: each edge $(f^+, f_i^+) \in E(\mathcal{D}^+)$ carries the same label α_i as its counterpart $(f, f_i) \in E(\mathcal{D})$, while all “vertical” edges (f, f^+) carry one and the same label λ . Clearly, the content of Fig. 4.3 is the same as of Fig. 4.2, up to notations. Now, a solution $f^+ : V(\mathcal{D}^+) \rightarrow \mathbb{C}$ on the first floor of \mathbf{D} is well defined due to the 3D consistency, and is determined by its value at one vertex of \mathcal{D}^+ and by λ . We can assume that f^+ is defined on $V(\mathcal{D})$ rather than on $V(\mathcal{D}^+)$, since these two sets are in a one-to-one correspondence. \square

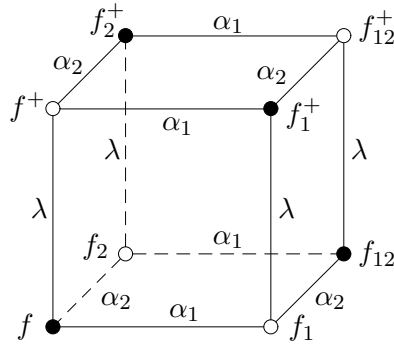
Figure 4.3: Elementary cube of \mathbf{D}

Theorem 4.3 *A 3D consistent system (4.4) on the quad-graph \mathcal{D} admits a zero curvature representation with spectral parameter dependent 2×2 matrices: there exist matrices attached to directed edges of \mathcal{D} ,*

$$L(\mathbf{e}, \alpha(\mathbf{e}); \lambda) : \vec{E}(\mathcal{D}) \rightarrow \mathrm{GL}_2(\mathbb{C})[\lambda], \quad (4.8)$$

such that for any quadrilateral face $(f, f_1, f_{12}, f_2) \in F(\mathcal{D})$ there holds

$$L(f_{12}, f_1, \alpha_2; \lambda)L(f_1, f, \alpha_1; \lambda) = L(f_{12}, f_2, \alpha_1; \lambda)L(f_2, f, \alpha_2; \lambda), \quad (4.9)$$

identically in λ .

Proof. Due to the linearity assumption, equations (4.7) can be solved for f_i^+ in terms of a Möbius (fractional-linear) transformation of f^+ with coefficients depending on f, f_i :

$$f_i^+ = L(f_i, f, \alpha_i; \lambda)[f^+], \quad (4.10)$$

Here we use the standard matrix notation for the action of Möbius transformations:

$$L[z] = (az + b)(cz + d)^{-1}, \quad \text{where} \quad L = \begin{pmatrix} a & b \\ c & d \end{pmatrix}. \quad (4.11)$$

Now 3D consistency for f_{12}^+ yields that for any f^+ there holds:

$$L(f_{12}, f_1, \alpha_2; \lambda)L(f_1, f, \alpha_1; \lambda)[f^+] = L(f_{12}, f_2, \alpha_1; \lambda)L(f_2, f, \alpha_2; \lambda)[f^+]. \quad (4.12)$$

Therefore, eq. (4.9) holds at least projectively, i.e., up to a scalar factor. A normalization of determinants of L (or any other suitable normalization) allows one to achieve that eq. (4.9) holds in the usual sense. \square

As an example, we derive a zero curvature representation for the complex cross-ratio equation (4.1). It will be convenient to re-define the spectral parameter in this case by $\lambda \mapsto \lambda^{-1}$, so that equations on the vertical faces of Fig. 4.3 read:

$$\frac{(f_i^+ - f^+)(f - f_i)}{(f^+ - f)(f_i - f_i^+)} = \lambda\alpha_i.$$

This gives the Möbius transformation (4.10) with

$$L(f_i, f, \alpha_i, \lambda) = I + \frac{\lambda\alpha_i}{f - f_i} \begin{pmatrix} f_i & -ff_i \\ 1 & -f \end{pmatrix} \quad (4.13)$$

The determinant of this matrix is constant (equal to $1 - \lambda\alpha_i$), therefore no further normalization is required. A more usual form of the transition matrices of the zero-curvature representation for the complex cross-ratio equation is obtained by the gauge transformation

$$L(f_i, f, \alpha_i; \lambda) \mapsto A^{-1}(f_i)L(f_i, f, \alpha_i; \lambda)A(f), \quad A(f) = \begin{pmatrix} 1 & f \\ 0 & 1 \end{pmatrix},$$

which leads to the matrices

$$L(f_i, f, \alpha_i; \lambda) = \begin{pmatrix} 1 & f - f_i \\ \lambda\alpha_i(f - f_i)^{-1} & 1 \end{pmatrix}. \quad (4.14)$$

These matrices (4.14) are interpreted as matrices of the Möbius transformations of the shifted quantities:

$$f_i^+ - f_i = L(f_i, f, \alpha_i; \lambda)[f^+ - f].$$

Thus, we have seen that 3D consistency of a 2D equation on a quad-graph with complex fields at vertices and with labelled edges implies existence of Bäcklund transformations and of the zero curvature representation. This is not a pure existence statement but rather a construction: both attributes can be derived in a systematic way starting with no more information than the equation itself, they are in a sense encoded in the equation provided it is 3D consistent.

Non-commutative equations. The truth contained in the last paragraph is by no means restricted to the situation for which it was demonstrated. For instance, in [BobSu2] it was extended to equations with fields on vertices taking values in some associative but *non-commutative* algebra \mathcal{A} with unit over a field \mathcal{K} , and with edge labels with values in \mathcal{K} . The transition matrices of the zero curvature representation are in this case 2×2 matrices with entries from \mathcal{A} . They act on \mathcal{A} according to eq. (4.11), where now the order of the factors is essential. The examples worked out in [BobSu2] include the non-commutative analogs of the Hirota equation (4.3) and of the cross-ratio equation (4.1) (recall that the latter equation with fields in $\mathcal{A} = \mathcal{C}\ell(\mathbb{R}^N)$ and with parameters α_i from $\mathcal{K} = \mathbb{R}$ governs discrete isothermic surfaces in \mathbb{R}^N). In particular:

Theorem 4.4 *The cross-ratio equation in an associative algebra \mathcal{A} is 3D consistent. It possesses a zero curvature representation with the transition matrices (4.14), where the inversion is treated in \mathcal{A} .*

Proof. The transition matrices are obtained from the equations themselves, in a full analogy with the scalar case. Verification of the zero curvature representation thus obtained is a matter of a direct computation. The non-commutative 3D consistency is a consequence of the zero curvature representation, see [BobSu2]. \square

We consider here one more equation of this kind:

$$(f_{12} - f)(f_2 - f_1) = \alpha_2 - \alpha_1, \quad (4.15)$$

with the vertex variables f taking values in \mathcal{A} and with the edge labels α from \mathcal{K} . Clearly, in the case when $\mathcal{A} = \mathcal{C}\ell(\mathbb{R}^N)$, solutions of this equation are special T-nets in \mathbb{R}^N :

$$f_{12} - f = \frac{\alpha_1 - \alpha_2}{|f_2 - f_1|^2} (f_2 - f_1). \quad (4.16)$$

In the latter vector form this equation was introduced in [Sch1] under the name of *discrete Calapso equation*.

Theorem 4.5 *Equation (4.15) in an associative algebra \mathcal{A} is 3D consistent. It possesses a zero curvature representation with the transition matrices*

$$L(f_i, f, \alpha_i; \lambda) = \begin{pmatrix} f & \lambda - \alpha_i - f f_i \\ 1 & -f_i \end{pmatrix}. \quad (4.17)$$

Proof. Equations (4.15) on the vertical faces of Fig. 4.3 read:

$$f_i^+ = f + (\lambda - \alpha_i)(f^+ - f_i)^{-1} = L(f_i, f, \alpha_i; \lambda) [f^+].$$

This gives the transition matrices, which can then be used to prove the 3D consistency, cf. [BobSu2]. \square

2D systems with fields on vertices. Regarding T-nets in quadrics, we encounter an equation with vertex variables $f : \mathbb{Z}^2 \rightarrow \mathbb{Q} = \{f \in \mathbb{R}^N : \langle f, f \rangle = \kappa^2\}$, and with no edge variables:

$$f_{12} - f = a(f_2 - f_1), \quad a = \frac{\langle f, f_1 - f_2 \rangle}{\kappa^2 - \langle f_1, f_2 \rangle} = \frac{2\langle f, f_1 - f_2 \rangle}{|f_1 - f_2|^2}. \quad (4.18)$$

For the quantities $\alpha_i = 2\langle f, f_i \rangle$ the labelling property (4.2) is fulfilled, but now they are functions of the vertex variables f rather than parameters of equation. Comparing eq. (4.18) with eq. (4.16), we see that the former can be regarded as a particular instance of the latter.

Theorem 4.6 *Equation (4.18), describing T-nets in quadrics, is 3D consistent. It possesses a zero curvature representation with the transition matrices with entries from $\mathcal{C}l(\mathbb{R}^N)$:*

$$L(f_i, f; \lambda) = \begin{pmatrix} f & \lambda + f_i f \\ 1 & -f_i \end{pmatrix}. \quad (4.19)$$

Proof. 3D consistency has been proven geometrically in Theorem 2.22. As for the transition matrices, we can take those from eq. (4.17) with

$$\alpha_i = 2\langle f, f_i \rangle = -f f_i - f_i f.$$

Note the geometrical meaning of the spectral parameter: $\lambda = 2\langle f, f^+ \rangle$ for the Bäcklund transformation f^+ from which the transition matrices are constructed. \square

2D systems with fields on edges. Another large class of 2D systems on quad-graphs build those with fields assigned to the *edges*, see Fig. 4.4. In this situation it is natural to assume that each elementary quadrilateral

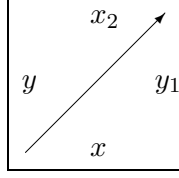

Figure 4.4: Elementary quadrilateral; fields on edges

carries a map $R : \mathcal{X} \times \mathcal{X} \mapsto \mathcal{X} \times \mathcal{X}$, with \mathcal{X} being the set where the fields x, y take values, so that $(x_2, y_1) = R(x, y)$. The 3D consistency of such maps can be encoded in the formula

$$R_{23} \circ R_{13} \circ R_{12} = R_{12} \circ R_{13} \circ R_{23}, \quad (4.20)$$

where each $R_{ij} : \mathcal{X}^3 \mapsto \mathcal{X}^3$ acts as the map R on the factors i, j of the cartesian product \mathcal{X}^3 , and acts identically on the third factor. This equation should be understood as follows. The fields x, y are supposed to be attached to the edges parallel to the 1st and the 2nd coordinate axes, respectively. Additionally, consider the fields z attached to the edges parallel to the 3rd coordinate axis. Fig. 4.5 illustrates eq. (4.20), its left-hand side corresponding to the chain of maps along the three rear faces of the cube:

$$(x, y) \xrightarrow{R_{12}} (x_2, y_1), \quad (x_2, z) \xrightarrow{R_{13}} (x_{23}, z_1), \quad (y_1, z_1) \xrightarrow{R_{23}} (y_{13}, z_{12}),$$

and the right-hand side corresponding to the chain of maps along the three front faces of the cube:

$$(y, z) \xrightarrow{R_{23}} (y_3, z_2), \quad (x, z_2) \xrightarrow{R_{13}} (x_3, z_{12}), \quad (x_3, y_3) \xrightarrow{R_{12}} (x_{23}, y_{13}).$$

So, eq. (4.20) assures that two ways of obtaining (x_{23}, y_{13}, z_{12}) from the initial data (x, y, z) lead to the same results. Maps with the property (4.20) were introduced by Drinfeld [Dr] under the name of *set-theoretical solutions of the Yang-Baxter equation*, an alternative name *Yang-Baxter maps* was proposed by Veselov in the recent study [V], see also references therein. The notion of the zero curvature representation makes perfect sense for Yang-Baxter maps, and is expressed as

$$L(y_1; \lambda)L(x_2; \lambda) = L(x; \lambda)L(y; \lambda).$$

There is a construction of zero curvature representations for Yang-Baxter maps with no more input information than the maps themselves [SuV], close

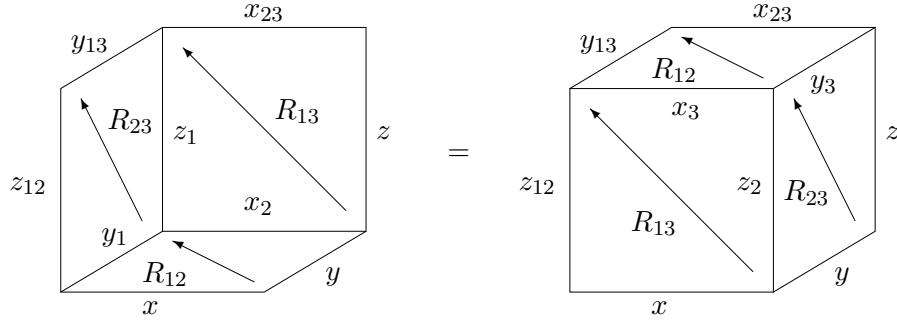

Figure 4.5: Yang–Baxter relation

in spirit to Theorem 4.3. Consider *parameter-dependent Yang-Baxter maps* $R(\alpha, \beta)$, with the parameters $\alpha, \beta \in \mathbb{C}$ assigned to the same edges of the quadrilateral on Fig. 4.4 as the fields x, y , opposite edges carrying the same parameters. Although this can be considered as a particular case of the general notion, by introducing $\tilde{X} = X \times \mathbb{C}$ and $\tilde{R}(x, \alpha; y, \beta) = R(\alpha, \beta)(x, y)$, it is convenient for us to keep the parameter separately. Thus, on Fig. 4.5 all edges parallel to the x (resp. y, z) axis, carry the parameter α (resp. β, γ), and the corresponding version of the Yang-Baxter relation reads:

$$R_{23}(\beta, \gamma)R_{13}(\alpha, \gamma)R_{12}(\alpha, \beta) = R_{12}(\alpha, \beta)R_{13}(\alpha, \gamma)R_{23}(\beta, \gamma). \quad (4.21)$$

Theorem 4.7 *Suppose that there is an effective action of the linear group $G = \text{GL}_N(\mathbb{C})$ on the set \mathcal{X} (i.e., $A \in G$ acts identically on \mathcal{X} only if $A = I$), and that the Yang-Baxter map $R(\alpha, \beta)$ has the following special form:*

$$x_2 = B(y, \beta, \alpha)[x], \quad y_1 = A(x, \alpha, \beta)[y]. \quad (4.22)$$

Here $A, B : \mathcal{X} \times \mathbb{C} \times \mathbb{C} \rightarrow G$ are some matrix-valued functions on \mathcal{X} depending on parameters α and β and $A[x]$ denotes the action of $A \in G$ on $x \in \mathcal{X}$. Then, whenever $(x_2, y_1) = R(\alpha, \beta)(x, y)$, there holds:

$$A(y_1, \beta, \lambda)A(x_2, \alpha, \lambda) = A(x, \alpha, \lambda)A(y, \beta, \lambda), \quad (4.23)$$

$$B(x_2, \alpha, \lambda)B(y_1, \beta, \lambda) = B(y, \beta, \lambda)B(x, \alpha, \lambda). \quad (4.24)$$

In other words, both $A(x, \alpha, \lambda)$ and $B^{-1}(x, \alpha, \lambda)$ form zero curvature representations for R .

4.2 Classification of 3D consistent systems

The notion of 3D consistency proves useful also in various classification problems of the integrable systems theory. We give here a presentation of results of [AdBS1] on the classification of integrable quad-graph equations (4.4) with complex fields on vertices and a complex-valued labelling of edges, and those of [AdBS2] on the classification of integrable equations with complex fields on edges (Yang-Baxter maps).

4.2.1 2D systems with fields on vertices and labelled edges

The classification of integrable equations of the type (4.4) is performed in [AdBS1] under the linearity and symmetry assumptions of the previous subsection, and one additional assumption. This latter one is less natural but it is fulfilled for the vast majority of interesting examples, including the complex cross-ratio and Hirota equations. An attentive look at eqs. (4.5), (4.6) tells that for the cross-ratio and for the Hirota equations there holds:

Tetrahedron property. The value f_{123} , existing due to 3D consistency, depends on f_1 , f_2 and f_3 , but not on f .

Thus, the fields f_1 , f_2 , f_3 and f_{123} (vertices of a white tetrahedron on Fig. 4.3) are related by a well-defined equation. Of course, due to symmetry the same holds for the fields f , f_{12} , f_{23} and f_{13} (vertices of the black tetrahedron).

Theorem 4.8 *The 3D consistent quad-graph equations (4.4) with the linearity, symmetry, and tetrahedron properties are exhausted, up to common Möbius transformations of the variables f and point transformations of the parameters α , by the following three lists Q , H , A (we use the abbreviations $x = f$, $u = f_1$, $v = f_2$, $y = f_{12}$, $\alpha = \alpha_1$, $\beta = \alpha_2$).*

List Q :

$$(Q1) \quad \alpha(x - v)(u - y) - \beta(x - u)(v - y) + \delta^2 \alpha \beta (\alpha - \beta) = 0,$$

$$(Q2) \quad \alpha(x - v)(u - y) - \beta(x - u)(v - y) + \alpha \beta (\alpha - \beta)(x + y + u + v) - \alpha \beta (\alpha - \beta)(\alpha^2 - \alpha \beta + \beta^2) = 0,$$

$$(Q3) \quad \sin(\alpha)(xu + vy) - \sin(\beta)(xv + uy) - \sin(\alpha - \beta)(xy + uv) + \delta^2 \sin(\alpha - \beta) \sin(\alpha) \sin(\beta) = 0,$$

$$(Q4) \quad \operatorname{sn}(\alpha)(xu + vy) - \operatorname{sn}(\beta)(xv + uy) - \operatorname{sn}(\alpha - \beta)(xy + uv) \\ + \operatorname{sn}(\alpha - \beta)\operatorname{sn}(\alpha)\operatorname{sn}(\beta)(1 + k^2xyuv) = 0,$$

where $\operatorname{sn}(\alpha) = \operatorname{sn}(\alpha; k)$ is the Jacobi elliptic function with the modulus k .

List H:

$$(H1) \quad (x - y)(u - v) + \beta - \alpha = 0,$$

$$(H2) \quad (x - y)(u - v) + (\beta - \alpha)(x + y + u + v) + \beta^2 - \alpha^2 = 0,$$

$$(H3) \quad \alpha(xu + vy) - \beta(xv + uy) + \delta(\alpha^2 - \beta^2) = 0.$$

List A:

$$(A1) \quad \alpha(x + v)(u + y) - \beta(x + u)(v + y) - \delta^2\alpha\beta(\alpha - \beta) = 0,$$

$$(A2) \quad \sin(\alpha)(xv + uy) - \sin(\beta)(xu + vy) - \sin(\alpha - \beta)(1 + xyuv) = 0.$$

Remarks.

1) Parameter δ in eqs. (Q1), (Q3), (H3), (A1) can be scaled away, so that one can assume without loss of generality that $\delta = 0$ or $\delta = 1$.

2) If one extends the transformation group of equations by allowing Möbius transformations to act on the variables x, y differently than on u, v (white and black subgraphs of a bipartite quad-graph), then eq. (A1) is related to (Q1) by the change $u \rightarrow -u, v \rightarrow -v$, and eq. (A2) is related to $(Q3)_{\delta=0}$ by the change $u \rightarrow 1/u, v \rightarrow 1/v$. So, really independent equations are given by the lists Q and H.

3) Note that the above lists contain the complex versions of the cross-ratio equation $(Q1)_{\delta=0}$, of the Hirota equation $(H3)_{\delta=0}$, and of the discrete Calapso equation (H1). The latter two equations are, probably, the oldest ones in our lists, they can be found in the work of Hirota [Hi]. Eqs. (Q1) and $(Q3)_{\delta=0}$ go back to [QNCL]. Eq. (Q4) was found in [Ad] (in the Weierstrass normalization of an elliptic curve; the observation that the formulas become much nicer in the Jacobi normalization is due to J. Hietarinta). Eqs. (Q2), $(Q3)_{\delta=1}$, (H2) and $(H3)_{\delta=1}$ seem to have appeared explicitly for the first time in [AdBS1].

The classification in Theorem 4.8 is performed modulo simultaneous Möbius transformations of all the variables. Applying this theorem, one would like to identify a 2D equation at hand with one of the equations of the lists Q, H, A. This task is greatly simplified by using some further information. For all 3D consistent equations with the linearity, symmetry and

the tetrahedron properties, the following holds. The symmetric biquadratic polynomial

$$g(x, u; \alpha, \beta) = QQ_{yv} - Q_yQ_v \quad (4.25)$$

admits a representation

$$g(x, u; \alpha, \beta) = k(\alpha, \beta)h(x, u; \alpha), \quad (4.26)$$

where the factor k is antisymmetric, $k(\beta, \alpha) = -k(\alpha, \beta)$, and the coefficients of the polynomial $h(x, u; \alpha)$ depend on a single parameter α in such a way that its discriminant

$$r(x) = h_u^2 - 2hh_{uu} \quad (4.27)$$

does not depend on α at all. Thus, we can characterize 3D consistent equations $Q = 0$ of Theorem 4.8 by much less complicated objects, namely the biquadratic symmetric polynomials $h(x, u; \alpha)$ of two variables and the quartic polynomials $r(x)$ of one variable. The action of the simultaneous Möbius transformations on the variables $x \mapsto (ax + b)/(cx + d)$ transforms the polynomials h, r as follows:

$$h(x, u; \alpha) \mapsto (cx + d)^2(cu + d)^2 h\left(\frac{ax + b}{cx + d}, \frac{au + b}{cu + d}; \alpha\right),$$

$$r(x) \mapsto (cx + d)^4 r\left(\frac{ax + b}{cx + d}\right).$$

Using such transformations one can put the polynomial $r(x)$ into one of the following canonical forms, depending on the distribution of its zeroes: either $r(x) = 0$, or $r(x) = 1$ (one quadruple zero), or $r(x) = x$ (one simple zero and one triple zero), or $r(x) = x^2$ (two double zeroes), or $r(x) = 1 - x^2$ (two simple zeroes and one double zero), or, finally, $r(x) = (1 - x^2)(1 - k^2x^2)$ with $k^2 \neq 1$ (four simple zeroes). So, the first step in identifying a 3D consistent equation is computing the polynomial $r(x)$ and putting it by a Möbius transformation into one of the canonical forms above. After that, one has to identify the polynomial $h(x, u; \alpha)$ with one of those corresponding to equations of our lists. This might require a further Möbius transformation in the cases $r(x) = 0$, $r(x) = 1$, and $r(x) = x^2$. In other three cases, $r(x) = x$, $r(x) = 1 - x^2$, and $r(x) = (1 - x^2)(1 - k^2x^2)$ (corresponding to equations (Q2), (Q3) and (Q4)), the polynomials $h(x, u; \alpha)$ are uniquely determined by $r(x)$, as a one-parameter family of symmetric biquadratic polynomials with the discriminant $r(x)$. In the non-degenerate case $r(x) = (1 - x^2)(1 - k^2x^2)$ this family is given by

$$h(x, u; \alpha) = \frac{1}{2 \operatorname{sn}(\alpha)} \left(x^2 + u^2 - 2 \operatorname{cn}(\alpha) \operatorname{dn}(\alpha) x u - \operatorname{sn}^2(\alpha) (1 + k^2 x^2 u^2) \right). \quad (4.28)$$

One can recognize this polynomial as the addition theorem for the elliptic function $\operatorname{sn}(x; k)$; more precisely, $h(x, u; \alpha) = 0$ if and only if $x = \operatorname{sn}(\xi; k)$ and $u = \operatorname{sn}(\eta; k)$ with $\xi - \eta = \pm\alpha$. This is the origin of the elliptic parametrization of the equation (Q4). Eqs. (Q1)–(Q3) are obtained from (Q4) by degenerations of an elliptic curve into rational ones. Similarly, eqs. (H1)–(H2) are limiting cases of (H3). One could be tempted to spoil down the lists Q, H to one item each. However, the limit procedures necessary for that are outside of our group of admissible (Möbius) transformations, and, on the other hand, in many situations the “degenerate” equations (Q1)–(Q3) and (H1)–(H2) are of interest for themselves. This resembles the situation with the list of six Painlevé equations and the coalescences connecting them.

4.2.2 2D systems with fields on edges

Consider Yang-Baxter maps $R : \mathcal{X} \times \mathcal{X} \rightarrow \mathcal{X} \times \mathcal{X}$, $(x, y) \mapsto (u, v)$ in the following special framework. Suppose that \mathcal{X} is an irreducible algebraic variety, and that R is a birational automorphism of $\mathcal{X} \times \mathcal{X}$. Thus, the birational map $R^{-1} : \mathcal{X} \times \mathcal{X} \rightarrow \mathcal{X} \times \mathcal{X}$, $(u, v) \mapsto (x, y)$ is defined. This is depicted on the left square on Fig. 4.6. Further, a non-degeneracy condition is imposed on R : rational maps $u(\cdot, y) : \mathcal{X} \rightarrow \mathcal{X}$ and $v(x, \cdot) : \mathcal{X} \rightarrow \mathcal{X}$ should be well defined for generic x , resp. y . In other words, birational maps $\bar{R} : \mathcal{X} \times \mathcal{X} \rightarrow \mathcal{X} \times \mathcal{X}$, $(x, v) \mapsto (u, y)$ and $\bar{R}^{-1} : \mathcal{X} \times \mathcal{X} \rightarrow \mathcal{X} \times \mathcal{X}$, $(u, y) \mapsto (x, v)$, called companion maps to R , should be defined. This requirement is visualized on the right square on Fig. 4.6. Birational maps R satisfying this condition are called *quadrirational* [AdBS2].

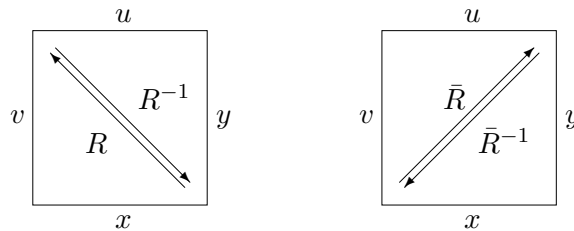

Figure 4.6: A map R on $\mathcal{X} \times \mathcal{X}$, its inverse and its companions

It turns out to be possible to classify all quadrirational maps in the case $\mathcal{X} = \mathbb{CP}^1$; we give a short presentation of the corresponding results [AdBS2].

Birational isomorphisms of $\mathbb{CP}^1 \times \mathbb{CP}^1$ are with necessity of the form

$$R: \quad u = \frac{a(y)x + b(y)}{c(y)x + d(y)}, \quad v = \frac{A(x)y + B(x)}{C(x)y + D(x)}, \quad (4.29)$$

where $a(y), \dots, d(y)$ are polynomials in y , and $A(x), \dots, D(x)$ are polynomials in x . For quadrirational maps, the degrees of all these polynomials are ≤ 2 . Dependent on the highest degree of the coefficients of each fraction in (4.29), we say that the map is [1:1], [1:2], [2:1], or [2:2]. The most rich and interesting subclass is [2:2]. A necessary condition for a map of this subclass to be quadrirational is that quartic polynomials $\delta(y) = a(y)d(y) - b(y)c(y)$ and $\Delta(x) = A(x)D(x) - B(x)C(x)$ are *simultaneously* of one of the following five types: they have either (I) four simple roots, or (II) two simple and two double roots, or (III) two double roots, or (IV) one simple and one triple root, or, finally, (V) one quadruple root.

Theorem 4.9 *Any quadrirational map [2:2] on $\mathbb{CP}^1 \times \mathbb{CP}^1$ is equivalent, under some change of variables acting by Möbius transformations independently on each field x, y, u, v , to exactly one of the following five maps:*

$$(R_I): \quad u = \alpha y P, \quad v = \beta x P, \quad P = \frac{(1 - \beta)x + \beta - \alpha + (\alpha - 1)y}{\beta(1 - \alpha)x + (\alpha - \beta)yx + \alpha(\beta - 1)y},$$

$$(R_{II}): \quad u = \frac{y}{\alpha} P, \quad v = \frac{x}{\beta} P, \quad P = \frac{\alpha x - \beta y + \beta - \alpha}{x - y},$$

$$(R_{III}): \quad u = \frac{y}{\alpha} P, \quad v = \frac{x}{\beta} P, \quad P = \frac{\alpha x - \beta y}{x - y},$$

$$(R_{IV}): \quad u = y P, \quad v = x P, \quad P = 1 + \frac{\beta - \alpha}{x - y},$$

$$(R_V): \quad u = y + P, \quad v = x + P, \quad P = \frac{\alpha - \beta}{x - y},$$

with some suitable constants α, β .

Each one of these maps is an involution and coincides with its companion maps, so that all four arrows on Fig. 4.6 are described by the same formulas. Note also that these maps come with the intrinsically built-in parameters α, β . Neither their existence nor a concrete dependence on parameters is presupposed in Theorem 4.9. A geometric interpretation of these parameters can be given in terms of singularities of the map; it turns out that the parameter α is naturally assigned to the edges x, u , while β is naturally assigned to the edges y, v .

The most remarkable fact about the maps (R_I) – (R_V) is their 3D consistency. For $\mathcal{T} = I, II, III, IV$ or V , denote the corresponding map $R_{\mathcal{T}}$ of Theorem 4.9 by $R_{\mathcal{T}}(\alpha, \beta)$, indicating the parameters explicitly. Moreover, for any $\alpha_1, \alpha_2, \alpha_3 \in \mathbb{C}$, denote by $R_{ij} = R_{\mathcal{T}}(\alpha_i, \alpha_j)$ the corresponding maps acting nontrivially on the i -th and the j -th factors of $(\mathbb{CP}^1)^3$.

Theorem 4.10 *For any $\mathcal{T} = I, II, III, IV$ or V , the maps R_{ij} satisfy the Yang–Baxter equation (4.20).*

Actually, the 3D consistency of quadrirational maps on $\mathbb{CP}^1 \times \mathbb{CP}^1$ takes place not only for the normal forms $R_{\mathcal{T}}(\alpha_i, \alpha_j)$ but under much more general circumstances. The only condition for quadrirational maps [2:2] consists in matching singularities along all edges of the cube (see details in [AdBS2]). Similar statements hold also for quadrirational maps [1:1] and [1:2], so that in the case $\mathcal{X} = \mathbb{CP}^1$ the properties of being quadrirational and of satisfying the Yang–Baxter equation (4.20) are related very closely.

The maps $R_{\mathcal{T}}$ of Theorem 4.9 admit a very nice geometric interpretation. Consider a pair of nondegenerate conics Q_1, Q_2 on the plane \mathbb{CP}^2 , so that both Q_i are irreducible algebraic varieties isomorphic to \mathbb{CP}^1 . Take $X \in Q_1, Y \in Q_2$, and let $\ell = \overline{XY}$ be the line through X, Y (well-defined if $X \neq Y$). Generically, the line ℓ intersects Q_1 at one further point $U \neq X$, and intersects Q_2 at one further point $V \neq Y$. This defines a map $\mathcal{F} : (X, Y) \mapsto (U, V)$, see Fig. 4.7 for the \mathbb{R}^2 picture. The map $\mathcal{F} : Q_1 \times Q_2 \mapsto Q_1 \times Q_2$ is quadrirational, is an involution and moreover coincides with its both companions. This follows immediately from the fact that, knowing one root of a quadratic equation, the second one is a rational function of the input data. Intersection points $X \in Q_1 \cap Q_2$ correspond to the singular points (X, X) of the map \mathcal{F} .

Generically, two conics intersect in four points, however, degeneracies can happen. Five possible types I – V of intersection of two conics are described in detail in [Ber]:

- I: four simple intersection points;
- II: two simple intersection points and one point of tangency;
- III: two points of tangency;
- IV: one simple intersection point and one point of the second order tangency;
- V: one point of the third order tangency.

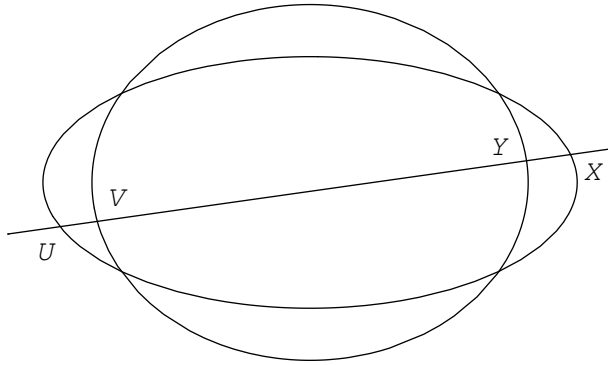

Figure 4.7: A quadrational map on a pair of conics

Using rational parametrizations of the conics:

$$\mathbb{CP}^1 \ni x \mapsto X(x) \in Q_1 \subset \mathbb{CP}^2, \quad \text{resp.} \quad \mathbb{CP}^1 \ni y \mapsto Y(y) \in Q_2 \subset \mathbb{CP}^2,$$

it is easy to see that \mathcal{F} pulls back to the map $F : (x, y) \mapsto (x_2, y_1)$ which is quadrational on $\mathbb{CP}^1 \times \mathbb{CP}^1$. One shows by a direct computation that the maps F for the above five situations are exactly the five maps listed in Theorem 4.9. Now, we obtain the following geometric interpretation of the statement of Theorem 4.10.

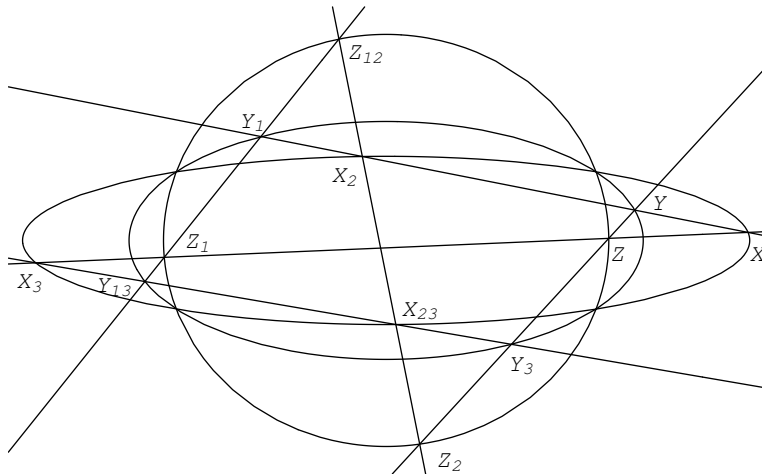

Figure 4.8: 3D consistency at a linear pencil of conics

Theorem 4.11 *Let Q_i , $i = 1, 2, 3$ be three non-degenerate members of a linear pencil of conics. Let $X \in Q_1$, $Y \in Q_2$ and $Z \in Q_3$ be arbitrary points on these conics. Define the maps \mathcal{F}_{ij} as above, corresponding to the pair of conics (Q_i, Q_j) . Set $(X_2, Y_1) = \mathcal{F}_{12}(X, Y)$, $(X_3, Z_1) = \mathcal{F}_{13}(X, Z)$, and $(Y_3, Z_2) = \mathcal{F}_{23}(Y, Z)$. Then*

$$\begin{aligned} X_{23} &= \overline{X_3 Y_3} \cap \overline{X_2 Z_2} \in Q_1, & Y_{13} &= \overline{X_3 Y_3} \cap \overline{Y_1 Z_1} \in Q_2, \\ Z_{12} &= \overline{Y_1 Z_1} \cap \overline{X_2 Z_2} \in Q_3. \end{aligned}$$

4.3 Integrability of discrete Laplace type equations

There exist discrete equations on graphs which are not covered by the theory we developed up to now.

Definition 4.12 *Let \mathcal{G} be a graph, with the set of vertices $V(\mathcal{G})$ and the set of edges $E(\mathcal{G})$. **Discrete Laplace type equations** on the graph \mathcal{G} for a function $f : V(\mathcal{G}) \rightarrow \mathbb{C}$ read:*

$$\sum_{x \sim x_0} \phi(f(x_0), f(x); \nu(x_0, x)) = 0. \quad (4.30)$$

There is one equation for every vertex $x_0 \in V(\mathcal{G})$; the summation is extended over the set of vertices of \mathcal{G} connected to x_0 by an edge; the function ϕ depends on some parameters $\nu : E(\mathcal{G}) \rightarrow \mathbb{C}$.

The classical *discrete Laplace equations* on \mathcal{G} are a particular case of this definition:

$$\sum_{x \sim x_0} \nu(x_0, x)(f(x) - f(x_0)) = 0, \quad (4.31)$$

with some weights $\nu : E(\mathcal{G}) \rightarrow \mathbb{R}_+$ attached to (undirected) edges of \mathcal{G} . We use the notation $\text{star}(x_0) = \text{star}(x_0; \mathcal{G})$ for the set of edges of \mathcal{G} incident to x_0 . In view of this, discrete Laplace type equations live on stars of \mathcal{G} .

The notion of *integrability* of discrete Laplace type equations is not well established yet. We propose here a construction which works under additional assumptions about the graph \mathcal{G} and is based on the relation to 3D consistent quad-graph equations (with fields on vertices). The additional structural assumption on \mathcal{G} is that it comes from a strongly regular polytopal cell decomposition of an oriented surface. To any such \mathcal{G} there corresponds canonically a dual cell decomposition \mathcal{G}^* (it is only defined up to isotopy, but can be fixed uniquely with the help of the Voronoi/Delaunay construction). If one assigns a direction to an edge $e \in E(\mathcal{G})$, then it will be assumed

that the dual edge $e^* \in E(\mathcal{G}^*)$ is also directed, in a way consistent with the orientation of the underlying surface, namely so that the pair (e, e^*) is positively oriented at its crossing point. This orientation convention implies that $e^{**} = -e$. The *double* \mathcal{D} is a quad-graph, constructed from \mathcal{G} and its dual \mathcal{G}^* as follows. The set of vertices of the double \mathcal{D} is $V(\mathcal{D}) = V(\mathcal{G}) \sqcup V(\mathcal{G}^*)$. Each pair of dual edges, say $e = (x_0, x_1) \in E(\mathcal{G})$ and $e^* = (y_0, y_1) \in E(\mathcal{G}^*)$, defines a quadrilateral (x_0, y_0, x_1, y_1) . These quadrilaterals constitute the faces of the cell decomposition (quad-graph) \mathcal{D} . Thus, a star of a vertex in $x_0 \in V(\mathcal{G})$ generates a flower of adjacent quadrilaterals from $F(\mathcal{D})$ around x_0 , see Figs. 4.9, 4.10.

This construction can be reversed. Start with a bipartite quad-graph \mathcal{D} , whose vertices $V(\mathcal{D})$ are decomposed into two complementary halves (“black” and “white” vertices), such that the ends of each edge from $E(\mathcal{D})$ are of different colours. For instance, any quad-graph embedded in \mathbb{C} , or in an open disc, is automatically bipartite. Any bipartite quad-graph produces two dual polytopal (not necessarily quadrilateral) cell decompositions \mathcal{G} and \mathcal{G}^* , with $V(\mathcal{G})$ being the “black” vertices of \mathcal{D} and $V(\mathcal{G}^*)$ being the “white” ones, and edges of \mathcal{G} (resp. of \mathcal{G}^*) connecting “black” (resp. “white”) vertices along the diagonals of each face of \mathcal{D} .

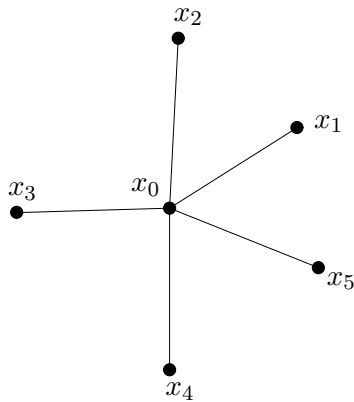

Figure 4.9: The star of the vertex x_0 in the graph \mathcal{G} .

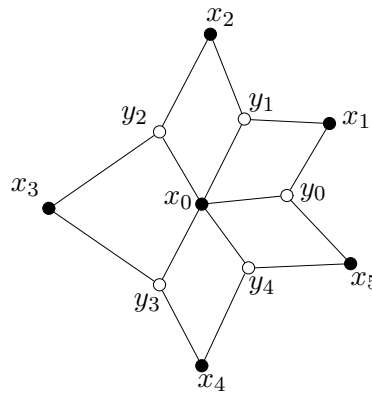

Figure 4.10: Faces of \mathcal{D} around the vertex x_0 .

In order to extract from this geometric construction some consequences for discrete Laplace type equations, we need the following deep and somewhat mysterious property, which quite often accompanies the 3D consistency of quad-graph equations with fields on vertices (4.4). We write here

this equation in slightly modified notations as

$$Q(x_0, y_0, x_1, y_1; \alpha_0, \alpha_1) = 0. \quad (4.32)$$

For notational simplicity, vertices x stand here for the corresponding fields $f(x)$; the edges (x_0, y_0) , (x_0, y_1) carry the labels α_0 , α_1 , respectively.

Definition 4.13 *An equation (4.32) possesses a **three-leg form** centered at the vertex x_0 , if it is equivalent to the equation*

$$\psi(x_0, y_0; \alpha_0) - \psi(x_0, y_1; \alpha_1) = \phi(x_0, x_1; \alpha_0, \alpha_1) \quad (4.33)$$

with some functions ψ, ϕ . The terms on the left-hand side correspond to “short” legs $(x_0, y_0), (x_0, y_1) \in E(\mathcal{D})$, while the right-hand side corresponds to the “long” leg $(x_0, x_1) \in E(\mathcal{G})$.

A summation of quad-graph equations for the flower of quadrilaterals adjacent to the “black” vertex $x_0 \in V(\mathcal{G})$ immediately leads, due to the telescoping effect, to the following statement.

Theorem 4.14 *a) Suppose that eq. (4.32) on a bipartite quad-graph \mathcal{D} possesses a three-leg form. Then a restriction of any solution $f : V(\mathcal{D}) \rightarrow \mathbb{C}$ to the “black” vertices $V(\mathcal{G})$ satisfies the discrete equations of the Laplace type,*

$$\sum_{k=1}^n \phi(x_0, x_k; \alpha_{k-1}, \alpha_k) = 0, \quad (4.34)$$

where n is the valence of the vertex x_0 in \mathcal{G} .

b) Conversely, given a solution $f : V(\mathcal{G}) \rightarrow \mathbb{C}$ of these Laplace type equations on a graph \mathcal{G} coming from a cell decomposition of a simply-connected surface, there exists a one-parameter family of its extensions $f : V(\mathcal{D}) \rightarrow \mathbb{C}$ satisfying eq. (4.4) on the double \mathcal{D} . Such an extension is uniquely defined by a value at one arbitrary vertex from $V(\mathcal{G}^)$.*

Sometimes it is more convenient to write the three-leg equation (4.33) in the multiplicative form:

$$\Psi(x_0, y_0; \alpha_0) / \Psi(x_0, y_1; \alpha_1) = \Phi(x_0, x_1; \alpha_0, \alpha_1) \quad (4.35)$$

with some functions Ψ, Φ , so that the Laplace type equations (4.34) also become multiplicative:

$$\prod_{k=1}^n \Phi(x_0, x_k; \alpha_{k-1}, \alpha_k) = 1. \quad (4.36)$$

This relation between integrable quad-graph equations and Laplace type equations was discovered in [BobSu1]. The three-leg forms for all quad-graph equations of Theorem 4.8 were found in [AdBS2]. The next theorem provides three-leg forms for all equations of the lists Q and H (the results for the list A follow from these ones). The functions $\phi(x, y; \alpha, \beta)$, resp. $\Phi(x, y; \alpha, \beta)$, corresponding to the “long” legs, yield integrable additive (resp. multiplicative) Laplace type equations on arbitrary planar graphs.

Theorem 4.15 *Three-leg forms exist for all equations from Theorem 4.8:*

(Q1) $_{\delta=0}$: Additive three-leg form with $\phi(x, y; \alpha, \beta) = \psi(x, y; \alpha - \beta)$,

$$\psi(x, u; \alpha) = \frac{\alpha}{x - u}. \quad (4.37)$$

(Q1) $_{\delta=1}$: Multiplicative three-leg form with $\Phi(x, y; \alpha, \beta) = \Psi(x, y; \alpha - \beta)$,

$$\Psi(x, u; \alpha) = \frac{x + \alpha - u}{x - \alpha - u}. \quad (4.38)$$

(Q2): Multiplicative three-leg form with $\Phi(x, y; \alpha, \beta) = \Psi(x, y; \alpha - \beta)$,

$$\Psi(x, u; \alpha) = \frac{(X + \alpha)^2 - u}{(X - \alpha)^2 - u}, \quad (4.39)$$

where $x = X^2$.

(Q3) $_{\delta=0}$: Multiplicative three-leg form with $\Phi(x, y; \alpha, \beta) = \Psi(x, y; \alpha/\beta)$,

$$\Psi(x, u; \alpha) = \frac{\alpha x - u}{x - \alpha u}. \quad (4.40)$$

(Q3) $_{\delta=1}$: Multiplicative three-leg form with $\Phi(x, y; \alpha, \beta) = \Psi(x, y; \alpha - \beta)$,

$$\Psi(x, u; \alpha) = \frac{\sin(X + \alpha) - u}{\sin(X - \alpha) - u}, \quad (4.41)$$

where $x = \sin(X)$.

(Q4): Multiplicative three-leg form with $\Phi(x, y; \alpha, \beta) = \Psi(x, y; \alpha - \beta)$,

$$\Psi(x, u; \alpha) = \frac{\Theta(X + \alpha)}{\Theta(X - \alpha)} \cdot \frac{\operatorname{sn}(X + \alpha) - u}{\operatorname{sn}(X - \alpha) - u}, \quad (4.42)$$

where $x = \operatorname{sn}(X)$, and $\Theta(X)$ is the Jacobi theta-function.

(H1): Additive three-leg form with

$$\phi(x, y; \alpha, \beta) = \frac{\alpha - \beta}{x - y}, \quad \psi(x, u; \alpha) = x + u. \quad (4.43)$$

(H2): *Multiplicative three-leg form with*

$$\Phi(x, y; \alpha, \beta) = \frac{x - y + \alpha - \beta}{x - y - \alpha + \beta}, \quad \Psi(x, u; \alpha) = x + u + \alpha. \quad (4.44)$$

(H3): *Multiplicative three-leg form with*

$$\Phi(x, y; \alpha, \beta) = \frac{\beta x - \alpha y}{\alpha x - \beta y}, \quad \Psi(x, u; \alpha) = xu + \delta\alpha. \quad (4.45)$$

One sees that there are only six “long” legs functions $\phi(x, y; \alpha, \beta)$, resp. $\Phi(x, y; \alpha, \beta)$, leading to integrable Laplace type equations on arbitrary planar graphs. Three of them are rational in x, y . Each of the corresponding Laplace type equations admits two extensions to a 3D consistent quad-graph equation: one from the list Q, where the “short” legs essentially coincide with the “long” ones – $(Q1)_{\delta=0}$, $(Q1)_{\delta=1}$, and $(Q3)_{\delta=0}$, and another one from the list H, with different “short” legs – (H1), (H2), and (H3). Other three functions Φ are rational in y only, and require for a uniformizing change of the variable x . Corresponding Laplace type equations admit only one extension to 3D consistent quad-graph equations – $(Q2)$, $(Q3)_{\delta=1}$, and $(Q4)$. Thus, restriction to a subgraph allows us to derive from 3D consistent quad-graph equations much more general systems, which clearly inherit the integrability. See a detailed realization of this idea for the $(Q4)$ equation in [AdS].

Remark. It should be mentioned that existence of a three-leg form allows us to derive (and, in some sense, to explain) the tetrahedron property of Sect. 4.2.1. Indeed, consider three faces adjacent to the vertex f_{123} on Fig. 4.2, namely the quadrilaterals $(f_1, f_{12}, f_{123}, f_{13})$, $(f_2, f_{23}, f_{123}, f_{12})$, and $(f_3, f_{13}, f_{123}, f_{23})$. A summation of the three-leg forms (centered at f_{123}) of equations corresponding to these three faces leads to the equation

$$\phi(f_{123}, f_1; \alpha_2, \alpha_3) + \phi(f_{123}, f_2; \alpha_3, \alpha_1) + \phi(f_{123}, f_3; \alpha_1, \alpha_2) = 0. \quad (4.46)$$

This equation relates the fields at the vertices of the “white” tetrahedron on Fig. 4.2. It can be interpreted as a discrete Laplace type equation coming from a spatial flower with three petals.

4.4 Geometry of boundary value problems for 3D consistent equations

We discuss here several aspects of the problem of embedding of a quad-graph into a regular multi-dimensional square lattice. As a combinatorial problem,

it was studied in a more general setting of arbitrary cubic complexes in [DoSh1, DoSh2, ShSh]. We are interested here in its relation to integrable equations.

We start with the question about correct initial value problems for discrete 2D equations on quad-graphs. Let P be a *path* in the quad-graph \mathcal{D} , i.e., a sequence of edges $\mathbf{e}_j = (v_j, v_{j+1}) \in E(\mathcal{D})$. We denote by $E(P) = \{\mathbf{e}_j\}$ and $V(P) = \{v_j\}$ the set of edges and the set of vertices of the path P , respectively. One says that the Cauchy problem for the path P is well-posed, if for any set of data $f_P : V(P) \rightarrow \mathbb{C}$ there exists a unique solution $f : V(\mathcal{D}) \rightarrow \mathbb{C}$ such that $f|_{V(P)} = f_P$.

The answer to this question was given in [AdV] with the help of the notion of a strip in \mathcal{D} .

Definition 4.16 *A strip in \mathcal{D} is a sequence of quadrilateral faces $q_j \in F(\mathcal{D})$ such that any pair q_{j-1}, q_j is adjacent along the edge $\mathbf{e}_j = q_{j-1} \cap q_j$, and $\mathbf{e}_j, \mathbf{e}_{j+1}$ are opposite edges of q_j . The edges \mathbf{e}_j are called traverse edges of the strip.*

So, any strip in \mathcal{D} can be associated to a label α sitting on all its traverse edges \mathbf{e}_j .

Theorem 4.17 *Consider one of the 3D consistent systems (4.4) of Theorem 4.8. Let \mathcal{D} be a finite simply connected quad-graph without self-crossing strips, and let P be a path without self-crossings in \mathcal{D} . Then:*

- i) If each strip in \mathcal{D} intersects P exactly once, then the Cauchy problem for P is well-posed.*
- ii) If some strip in \mathcal{D} intersects P more than once, then the Cauchy problem for P is overdetermined (has in general no solutions).*
- iii) If some strip in \mathcal{D} does not intersect P , then the Cauchy problem for P is underdetermined (has in general more than one solution).*

It should be mentioned that this theorem is not valid for equations without the 3D consistency property. One of the proofs of the statement i) in [AdV] is based on the embedding of \mathcal{D} into the unit cube of \mathbb{Z}^N , where N is the number of edges in P (the number of distinct strips in \mathcal{D}). In this embedding the path P turns into the path $(0, 0, 0, \dots, 0), (1, 0, 0, \dots, 0), (1, 1, 0, \dots, 0), \dots, (1, 1, 1, \dots, 1)$. It is clear that for a 3D consistent equation the Cauchy problem for this path is well-posed.

A different aspect of embeddability of the quad-graph \mathcal{D} into a regular multi-dimensional cubic lattice was studied in [BobMeS], based on the following result [KeS].

Theorem 4.18 *A quad-graph \mathcal{D} admits an embedding in \mathbb{C} with all rhombic faces if and only if the following two conditions are satisfied:*

- i) No strip crosses itself or is periodic.*
- ii) Two distinct strips cross each other at most once.*

Given a rhombic embedding $p : V(\mathcal{D}) \rightarrow \mathbb{C}$, one defines the following function on the directed edges of \mathcal{D} with values in $\mathbb{S}^1 = \{\theta \in \mathbb{C} : |\theta| = 1\}$:

$$\theta(x, y) = p(y) - p(x), \quad \forall (x, y) \in \vec{E}(\mathcal{D}). \quad (4.47)$$

This function can be called a *labelling of directed edges*, since it satisfies $\theta(-\mathbf{e}) = -\theta(\mathbf{e})$ for any $\mathbf{e} \in \vec{E}(\mathcal{D})$, and the values of θ on two opposite and equally directed edges of any quadrilateral from $F(\mathcal{D})$ are equal. See Fig. 4.11. For any labelling $\theta : \vec{E}(\mathcal{D}) \rightarrow \mathbb{S}^1$ of directed edges, the function $\alpha = \theta^2 : E(\mathcal{D}) \rightarrow \mathbb{S}^1$ is a *labelling* of (undirected) edges of \mathcal{D} in our usual sense.

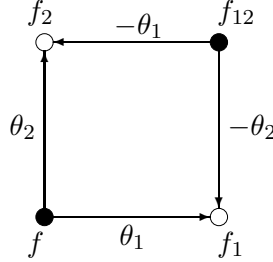

Figure 4.11: Labelling of directed edges

Definition 4.19 *A rhombic embedding $p : V(\mathcal{D}) \rightarrow \mathbb{C}$ of a quad-graph \mathcal{D} is called **quasicrystallic**, if the set of values of the function $\theta : \vec{E}(\mathcal{D}) \rightarrow \mathbb{S}^1$ defined by (4.47), is finite, say $\Theta = \{\pm\theta_1, \dots, \pm\theta_d\}$.*

It is of a central importance that any quasicrystallic rhombic embedding p can be seen as a sort of a projection of a certain two-dimensional subcomplex (combinatorial surface) $\Omega_{\mathcal{D}}$ of a multi-dimensional regular square lattice \mathbb{Z}^d . The vertices of $\Omega_{\mathcal{D}}$ are given by a map $P : V(\mathcal{D}) \rightarrow \mathbb{Z}^d$ constructed as follows. Fix some $x_0 \in V(\mathcal{D})$, and set $P(x_0) = \mathbf{0}$. The images in \mathbb{Z}^d of all other vertices of \mathcal{D} are defined recurrently by the property:

for any two neighbors $x, y \in V(\mathcal{D})$, if $p(y) - p(x) = \pm\theta_i \in \Theta$, then

$P(y) - P(x) = \pm e_i$, where e_i is the i -th coordinate vector of \mathbb{Z}^d .

Edges and faces of $\Omega_{\mathcal{D}}$ correspond to edges and faces of \mathcal{D} , so that the combinatorics of $\Omega_{\mathcal{D}}$ is that of \mathcal{D} .

To exploit possibilities provided by the 3D consistency, extend the labeling $\theta : \vec{E}(\mathcal{D}) \rightarrow \mathbb{S}^1$ to all edges of \mathbb{Z}^d , assuming that all edges parallel to (and directed as) e_k carry the label θ_k . This gives, of course, also the labelling $\alpha = \theta^2$ of undirected edges of \mathbb{Z}^d . Now, any 3D consistent equation can be imposed not only on $\Omega_{\mathcal{D}}$, but on the whole of \mathbb{Z}^d :

$$Q(f, f_j, f_{jk}, f_k; \alpha_j, \alpha_k) = 0, \quad 1 \leq j \neq k \leq d. \quad (4.48)$$

Here indices stand for the shifts into the coordinate directions. Obviously, for any solution $f : \mathbb{Z}^d \rightarrow \mathbb{C}$ of eq. (4.48), its restriction to $V(\Omega_{\mathcal{D}}) \sim V(\mathcal{D})$ gives a solution of the corresponding equation on the quad-graph \mathcal{D} . As for the reverse procedure, i.e., for the extension of an arbitrary solution of eq. (4.4) from \mathcal{D} to \mathbb{Z}^d , more thorough considerations are necessary. An elementary step of such an extension consists of finding f at the eighth vertex of an elementary 3D cube from the known values at seven vertices, see Fig. 4.12. This can be alternatively viewed as a flip (elementary transformation) on the set of rhombically embedded quad-graphs \mathcal{D} , or on the set of the corresponding surfaces $\Omega_{\mathcal{D}}$ in \mathbb{Z}^d . The 3D consistency assures that any quad-graph \mathcal{D} (or any corresponding surface $\Omega_{\mathcal{D}}$) obtainable from the original one by such flips, carries a unique solution of eq. (4.48) which is an extension of the original one.

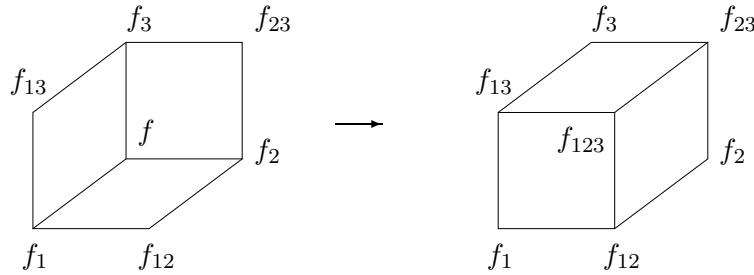

Figure 4.12: Elementary flip

Definition 4.20 For a given set $V \subset \mathbb{Z}^d$, its **hull** $\mathcal{H}(V)$ is the minimal set $\mathcal{H} \subset \mathbb{Z}^d$ containing V and satisfying the condition: if three vertices of an elementary square belong to \mathcal{H} , then so does the fourth vertex.

One shows by induction that for an arbitrary connected subcomplex of \mathbb{Z}^d with the set of vertices V , its hull is a *brick*

$$\Pi_{\mathbf{a}, \mathbf{b}} = \{ \mathbf{n} = (n_1, \dots, n_d) \in \mathbb{Z}^d : a_k \leq n_k \leq b_k, k = 1, \dots, d \}, \quad (4.49)$$

where

$$a_k = a_k(V) = \min_{\mathbf{n} \in V} n_k, \quad b_k = b_k(V) = \max_{\mathbf{n} \in V} n_k, \quad k = 1, \dots, d, \quad (4.50)$$

and in the case that n_k are unbounded from below or from above on V , we set $a_k(V) = -\infty$, resp. $b_k(V) = \infty$.

Combinatorially, all points of the hull $\mathcal{H}(V(\Omega_{\mathcal{D}}))$ can be reached by flips of Fig. 4.12, starting from $\Omega_{\mathcal{D}}$. However, there might be obstructions, having nothing to do with 3D consistency, for extending solutions of eq. (4.4) from a combinatorial surface (two-dimensional subcomplex of \mathbb{Z}^d) to its hull. For instance, the surface Ω shown on Fig. 4.13 supports solutions of eq. (4.4) which *cannot* be extended to solutions of eq. (4.48) on the whole of $\mathcal{H}(V(\Omega))$: the recursive extension will lead to contradictions. The reason for this is a non-monotonicity of Ω : it contains pairs of points which cannot be connected by a monotone path, i.e., by a path in Ω with all directed edges lying in one octant of \mathbb{Z}^d . However, such surfaces Ω *do not* come from rhombic embeddings, and in the case of $\Omega_{\mathcal{D}}$ there will be no contradictions.

Theorem 4.21 *Let the combinatorial surface $\Omega_{\mathcal{D}}$ in \mathbb{Z}^d come from a rhombic embedding of a quad-graph \mathcal{D} , and let its hull be $\mathcal{H}(V(\Omega_{\mathcal{D}})) = \Pi_{\mathbf{a}, \mathbf{b}}$. An arbitrary solution of eq. (4.4) on $\Omega_{\mathcal{D}}$ can be uniquely extended to a solution of eq. (4.48) on $\Pi_{\mathbf{a}, \mathbf{b}}$.*

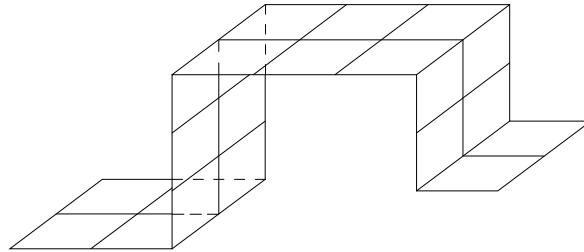

Figure 4.13: A non-monotone surface in \mathbb{Z}^3

Note that intersections of $\Omega_{\mathcal{D}}$ with bricks correspond to *combinatorially convex subsets* of \mathcal{D} , as defined in [Me2].

Chapter 5

Discrete complex analysis. Linear theory

5.1 Basic notions of the discrete linear complex analysis

Many constructions in the discrete complex analysis are parallel to the discrete differential geometry in the space of the real dimension 2.

Recall that a harmonic function $u : \mathbb{R}^2 \simeq \mathbb{C} \rightarrow \mathbb{R}$ is characterized by the relation:

$$\Delta u = \frac{\partial^2 u}{\partial x^2} + \frac{\partial^2 u}{\partial y^2} = 0.$$

A conjugate harmonic function $v : \mathbb{R}^2 \simeq \mathbb{C} \rightarrow \mathbb{R}$ is defined by the Cauchy-Riemann equations:

$$\frac{\partial v}{\partial y} = \frac{\partial u}{\partial x}, \quad \frac{\partial v}{\partial x} = -\frac{\partial u}{\partial y}.$$

Equivalently, $f = u + iv : \mathbb{R}^2 \simeq \mathbb{C} \rightarrow \mathbb{C}$ is holomorphic, i.e., satisfies the Cauchy-Riemann equation:

$$\frac{\partial f}{\partial y} = i \frac{\partial f}{\partial x}.$$

The real and the imaginary parts of a holomorphic function are harmonic, and any real-valued harmonic function can be considered as a real part of a holomorphic function.

A standard classical way to discretize these notions, going back to Ferrand [F] and Duffin [Du1], is the following. A function $u : \mathbb{Z}^2 \rightarrow \mathbb{R}$ is called

discrete harmonic, if

$$(\Delta u)_{m,n} = u_{m+1,n} + u_{m-1,n} + u_{m,n+1} + u_{m,n-1} - 4u_{m,n} = 0.$$

A natural definition domain of a conjugate discrete harmonic function $v : (\mathbb{Z}^2)^* \rightarrow \mathbb{R}$ is the *dual lattice*:

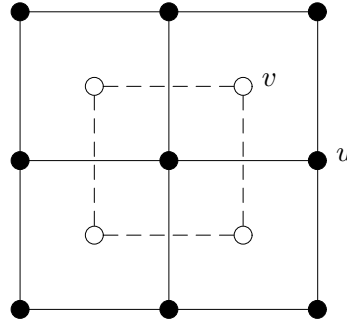

The defining *discrete Cauchy–Riemann equations* read:

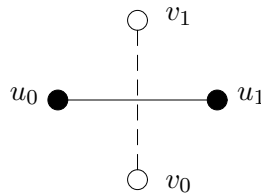

$$v_1 - v_0 = u_1 - u_0$$

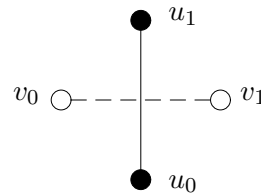

$$v_1 - v_0 = -(u_1 - u_0)$$

The corresponding *discrete holomorphic function* $f : \mathbb{Z}^2 \cup (\mathbb{Z}^2)^* \rightarrow \mathbb{C}$ is defined on the superposition of the original square lattice \mathbb{Z}^2 and the dual one $(\mathbb{Z}^2)^*$, by the formula $f = \begin{cases} u, & \bullet, \\ iv, & \circ, \end{cases}$ which comes to replace the smooth one $f = u + iv$. Remarkably, the discrete Cauchy–Riemann equation for f is one and the same for the both pictures above:

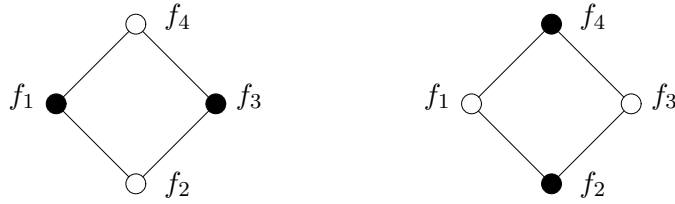

$$f_4 - f_2 = i(f_3 - f_1).$$

This discretization of the Cauchy-Riemann equations apparently preserves the most number of important structural features, and the corresponding theory has been developed in [F, Do1]. A pioneering step in the direction of a further generalization of the notions of discrete harmonic and discrete holomorphic functions was undertaken by Duffin [Do2], where the combinatorics of \mathbb{Z}^2 was given up in favor of arbitrary planar graphs with rhombic faces. A far reaching generalization of these ideas was given by Mercat [Me1], who extended the theory to discrete Riemann surfaces.

Discrete harmonic functions can be defined for an arbitrary graph \mathcal{G} with the set of vertices $V(\mathcal{G})$ and the set of edges $E(\mathcal{G})$.

Definition 5.1 For a given weight function $\nu : E(\mathcal{G}) \rightarrow \mathbb{R}_+$ on edges of \mathcal{G} , the **Laplacian** is the operator acting on functions $f : V(\mathcal{G}) \rightarrow \mathbb{C}$ by

$$(\Delta f)(x_0) = \sum_{x \sim x_0} \nu(x_0, x)(f(x) - f(x_0)), \quad (5.1)$$

where the summation is extended over the set of vertices x connected to x_0 by an edge. A function $f : V(\mathcal{G}) \rightarrow \mathbb{C}$ is called **discrete harmonic** (with respect to the weights ν), if $\Delta f = 0$.

The positivity of weights ν in this definition is important from the analytic point of view, as it guarantees, e.g., the maximum principle for the discrete Laplacian under suitable boundary conditions (so that discrete harmonic functions come as minimizers of a convex functional). However, from the pure algebraic point of view, one might consider at times also arbitrary real (or even complex) weights.

If \mathcal{G} comes from a cellular decomposition of an oriented surface, let \mathcal{G}^* be its dual graph, and let the quad-graph \mathcal{D} be its double, see Sect. 4.3. Extend the weight function to the edges of \mathcal{G}^* according to the rule

$$\nu(e^*) = 1/\nu(e). \quad (5.2)$$

Definition 5.2 A function $f : V(\mathcal{D}) \rightarrow \mathbb{C}$ is called **discrete holomorphic** (with respect to the weights ν), if for any positively oriented quadrilateral $(x_0, y_0, x_1, y_1) \in F(\mathcal{D})$ (see Fig. 5.1) there holds:

$$\frac{f(y_1) - f(y_0)}{f(x_1) - f(x_0)} = i\nu(x_0, x_1) = -\frac{1}{i\nu(y_0, y_1)}. \quad (5.3)$$

These equations are called **discrete Cauchy-Riemann equations**.

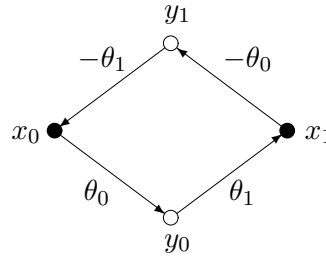

Figure 5.1: Positively oriented quadrilateral, with a labelling of directed edges

The relation between discrete harmonic and discrete holomorphic functions is the same as in the smooth case. It is given by the following statement which is a particular case of Theorem 4.14.

Theorem 5.3 a) If a function $f : V(\mathcal{D}) \rightarrow \mathbb{C}$ is discrete holomorphic, then its restrictions to $V(\mathcal{G})$ and to $V(\mathcal{G}^*)$ are discrete harmonic.

b) Conversely, any discrete harmonic function $f : V(\mathcal{G}) \rightarrow \mathbb{C}$ admits a family of discrete holomorphic extensions to $V(\mathcal{D})$, differing by an additive constant on $V(\mathcal{G}^*)$. Such an extension is uniquely defined by a value at one arbitrary vertex $y \in V(\mathcal{G}^*)$.

5.2 Moutard transformation for Cauchy-Riemann equations on quad-graphs

Observe that discrete Cauchy-Riemann equations (5.3) is formally not different from the Moutard equations (2.43) for T-nets. One only has to fix the orientation of all quadrilateral faces $(x_0, y_0, x_1, y_1) \in F(\mathcal{D})$. We assume that it is inherited from the orientation of the underlying surface.

One can apply now the Moutard transformation of Sect. 2.3 to discrete holomorphic functions. To this aim, one has to choose the orientation of

all elementary quadrilaterals on Fig. 5.2. This can be done, for example, as follows: for the quadrilaterals $(x_0^+, y_0^+, x_1^+, y_1^+) \in F(\mathcal{D}^+)$, choose the orientation to coincide with that of the corresponding $(x_0, y_0, x_1, y_1) \in F(\mathcal{D})$. For a “vertical” quadrilateral over an edge $(x, y) \in E(\mathcal{D})$, assume that $x \in V(\mathcal{G})$, $y \in V(\mathcal{G}^*)$, and choose the positive orientation corresponding to the cyclic order (x, y, y^+, x^+) of its vertices. Observe that under this convention, two opposite “vertical” quadrilaterals are always oriented differently.

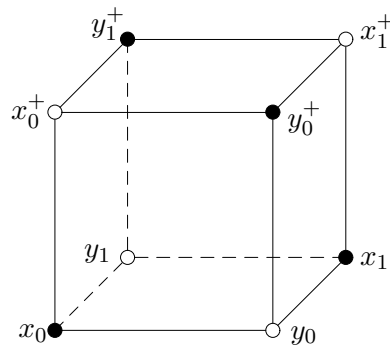

Figure 5.2: Elementary cube of \mathbf{D}

In the case of arbitrary quad-graphs, one has to generalize one more ingredient of the Moutard transformation, namely the data (MT_2^Δ) .

Theorem 5.4 *On an arbitrary bipartite quad-graph \mathcal{D} , valid initial conditions for a Moutard transformation of the discrete Cauchy-Riemann equations consist of*

(MCR_1^Δ) *value of f at one point $x^+(0) \in V(\mathcal{D}^+)$;*

(MCR_2^Δ) *values of weights on “vertical” quadrilaterals (x, y, y^+, x^+) attached to all edges (x, y) of a Cauchy path in \mathcal{D} .*

See Theorem 4.17 for necessary and sufficient conditions for a path to be a Cauchy path, i.e., to support initial data for a well-posed Cauchy problem. It is natural to assign the weights on the “vertical” quadrilaterals to the underlying edges of \mathcal{D} .

Weights ν on the faces of \mathcal{D} together with the data (MCR_2^Δ) yield the transformed weights ν^+ on the faces of \mathcal{D}^+ , as well as the weights over all edges of $E(\mathcal{D})$. This can be considered as a Moutard transformation for

Cauchy-Riemann equations on \mathcal{D} . Finding a solution $f : V(\mathcal{D}^+) \rightarrow \mathbb{C}$ of the transformed equations requires additionally the datum (MCR_1^{Δ}) .

Note that the system of weights ν is highly redundant, due to eq. (5.2). To fix the ideas in writing the equations, we stick to the weights attached to the “black” diagonals of the quadrilateral faces of the complex \mathbf{D} . On the ground floor, these are the edges of the “black” graph \mathcal{G} ; on the first floor, these are the edges of the “black” graph which is a copy of \mathcal{G}^* ; and for the “vertical” faces, these are the edges (x, y^+) , with $x \in V(\mathcal{G})$ and $y \in V(\mathcal{G}^*)$. Needless to say that the latter weights can be assigned to the quad-graph edges $(x, y) \in E(\mathcal{D})$. So, we write the discrete Cauchy-Riemann equations as follows:

$$f(y_1) - f(y_0) = i\nu(x_0, x_1)(f(x_1) - f(x_0)), \quad (5.4)$$

$$f(x_0^+) - f(x_1^+) = i\nu(y_0^+, y_1^+)(f(y_1^+) - f(y_0^+)), \quad (5.5)$$

$$f(x^+) - f(y) = i\nu(x, y^+)(f(y^+) - f(x)). \quad (5.6)$$

Denote, for the sake of brevity,

$$\nu = \nu(x_0, x_1), \quad \nu^+ = \nu(y_0^+, y_1^+), \quad \mu_{jk} = \nu(x_j, y_k^+).$$

Regarding the weights ν , μ_{00} , and μ_{01} as the input of the Moutard transformation on an elementary hexahedron of \mathbf{D} , its output consists of the weights ν^+ , μ_{10} , and μ_{11} , given by (cf. eq. (2.46))

$$\nu^+ \nu = -\mu_{11} \mu_{00} = -\mu_{10} \mu_{01} = \frac{\nu \mu_{00} \mu_{01}}{\mu_{00} - \mu_{01} - \nu}. \quad (5.7)$$

This transformation is well defined for real weights ν , μ_{jk} , but it *does not* preserve, in general, positivity of the weights ν .

To give a different form of this transformation, observe that relation $\mu_{11} \mu_{00} = \mu_{10} \mu_{01}$ for each elementary quadrilateral (x_0, y_0, x_1, y_1) of \mathcal{D} yields the existence of the function $\theta : V(\mathcal{D}) \rightarrow \mathbb{C}$, defined up to a constant factor, such that $i\mu_{jk} = \theta(y_k)/\theta(x_j)$. Moreover, choosing $\theta(x_0)$ real at some point $x_0 \in V(\mathcal{G})$, one sees that θ takes real values on $V(\mathcal{G})$ and imaginary values on $V(\mathcal{G}^*)$. An easy computation shows that the last equation in (5.7) is equivalent to

$$\theta(y_1) - \theta(y_0) = i\nu(x_0, x_1)(\theta(x_1) - \theta(x_0)),$$

so that the function θ is discrete holomorphic with respect to the weights ν . For the transformed weights ν^+ one finds:

$$\nu^+ \nu = \frac{\theta(y_0)\theta(y_1)}{\theta(x_0)\theta(x_1)}. \quad (5.8)$$

Conversely, an arbitrary discrete holomorphic function $\theta : V(\mathcal{D}) \rightarrow \mathbb{C}$ defines, via eq. (5.8), a Moutard transformation of the discrete Cauchy-Riemann equations. It should be mentioned that the data (MCR_2^Δ) can be re-formulated in terms of the function θ :

(MCR_2^Δ) values of θ at all vertices along a Cauchy path in \mathcal{D} .

Remark. Moutard transformation for discrete Cauchy-Riemann equations yields, by restriction to the “black” graphs, a sort of Darboux transformation of arbitrary discrete Laplacians on \mathcal{G} into discrete Laplacians on \mathcal{G}^* . A further discussion of this transformation for discrete Laplace operators can be found in [NieSD, DoGNS].

5.3 Integrable discrete Cauchy-Riemann equations

We now turn to a fruitful question about “stationary points” of the Moutard transformation discussed in the previous section. More precisely, this is the question about conditions on the weights $\nu : E(\mathcal{G}) \rightarrow \mathbb{R}_+$ such that there exists a Moutard transformation for which the opposite faces of any elementary hexahedron of \mathbf{D} (see Fig. 5.2) carry *identical* equations.

Theorem 5.5 *A system of discrete Cauchy-Riemann equations with the function $\nu : E(\mathcal{G}) \sqcup E(\mathcal{G}^*) \rightarrow \mathbb{R}_+$ satisfying (5.2) admits a Moutard transformation into itself, if and only if for all $x_0 \in V(\mathcal{G})$ and for all $y_0 \in V(\mathcal{G}^*)$ the following conditions are fulfilled:*

$$\prod_{e \in \text{star}(x_0; \mathcal{G})} \frac{1 + i\nu(e)}{1 - i\nu(e)} = 1, \quad \prod_{e^* \in \text{star}(y_0; \mathcal{G}^*)} \frac{1 + i\nu(e^*)}{1 - i\nu(e^*)} = 1. \quad (5.9)$$

Proof. Opposite faces of \mathcal{D} and \mathcal{D}^+ carry identical equations, if $\nu^+\nu = 1$ in eq. (5.7). Clearly, this yields also $\mu_{11}\mu_{00} = \mu_{10}\mu_{01} = -1$, which means that the opposite “vertical” faces also support identical equations (recall that opposite “vertical” faces carry different orientation). Moreover, given $\nu = \nu(x_0, x_1)$ for an elementary quadrilateral (x_0, y_0, x_1, y_1) of \mathcal{D} , we find that the input data μ_{00}, μ_{01} of the Moutard transformation should be related as follows:

$$\frac{\nu\mu_{00}\mu_{01}}{\mu_{00} - \mu_{01} - \nu} = 1 \quad \Leftrightarrow \quad \mu_{01} = \frac{\mu_{00} - \nu}{\mu_{00}\nu + 1} = \begin{pmatrix} 1 & -\nu \\ \nu & 1 \end{pmatrix} [\mu_{00}],$$

where the standard notation for the action of $PGL_2(\mathbb{C})$ on \mathbb{C} by Möbius transformations is used. This means that all the weights on the vertical

faces of a “stationary” Moutard transformation are completely defined by just one of them, so that such transformations form a one-parameter family. To derive a condition for ν for the existence of a “stationary” Moutard transformation, consider a flower of quadrilaterals (x_0, y_{k-1}, x_k, y_k) around $x_0 \in V(\mathcal{G})$ (see Fig. 4.10). In the natural notations, we find:

$$\mu_{0,k} = \frac{\mu_{0,k-1} - \nu_k}{\mu_{0,k-1}\nu_k + 1} = \begin{pmatrix} 1 & -\nu_k \\ \nu_k & 1 \end{pmatrix} [\mu_{0,k-1}].$$

Running around x_0 should for any μ_{00} return its value, which means that the matrix product $\begin{pmatrix} A & -B \\ B & A \end{pmatrix} = \prod_k \begin{pmatrix} 1 & -\nu_k \\ \nu_k & 1 \end{pmatrix}$ should be proportional to the identity matrix. This matrix product is easily computed:

$$A = \frac{1}{2} \left(\prod_k (1 + i\nu_k) + \prod_k (1 - i\nu_k) \right), \quad B = \frac{1}{2i} \left(\prod_k (1 + i\nu_k) - \prod_k (1 - i\nu_k) \right),$$

and the condition $B = 0$ is equivalent to the first equality in (5.9). The second condition in (5.9) is proved similarly, by considering a flower of quadrilaterals around $y_0 \in V(\mathcal{G}^*)$. \square

Thus, existence of a “stationary” Moutard transformation singles out a special class of discrete Cauchy-Riemann equations, which have to be considered as 2D systems with the 3D consistency property, see Sect. 4.1. In other words, such Cauchy-Riemann equations should be termed *integrable*. The main difference as compared with the examples in Sect. 4.1, is that discrete Cauchy-Riemann equations naturally depend on the *orientation* of the elementary quadrilaterals, and that their parameters ν are apparently assigned not to the edges of the quad-graph, but rather to diagonals of its faces.

The integrability condition (5.9) admits a nice geometric interpretation. It is convenient (especially for positive real-valued ν) to use the notation

$$\nu(e) = \tan \frac{\phi(e)}{2}, \quad \phi(e) \in (0, \pi). \quad (5.10)$$

The condition $\nu(e^*) = 1/\nu(e)$ is translated into

$$\phi(e^*) = \pi - \phi(e), \quad (5.11)$$

while the condition (5.9) says that for all $x_0 \in V(\mathcal{G})$ and for all $y_0 \in V(\mathcal{G}^*)$ there holds:

$$\prod_{e \in \text{star}(x_0; \mathcal{G})} \exp(i\phi(e)) = 1, \quad \prod_{e^* \in \text{star}(y_0; \mathcal{G}^*)} \exp(i\phi(e^*)) = 1. \quad (5.12)$$

5.3. INTEGRABLE DISCRETE CAUCHY-RIEMANN EQUATIONS 121

These conditions should be compared with conditions [KeS] characterizing the angles $\phi : E(\mathcal{G}) \sqcup E(\mathcal{G}^*) \rightarrow (0, \pi)$ of a rhombic embedding of a quad-graph \mathcal{D} , which consist of (5.11) and

$$\sum_{e \in \text{star}(x_0; \mathcal{G})} \phi(e) = 2\pi, \quad \sum_{e^* \in \text{star}(y_0; \mathcal{G}^*)} \phi(e^*) = 2\pi, \quad (5.13)$$

for all $x_0 \in V(\mathcal{G})$ and for all $y_0 \in V(\mathcal{G}^*)$. Thus, the integrability condition (5.12) says that the system of angles $\phi : E(\mathcal{G}) \sqcup E(\mathcal{G}^*) \rightarrow (0, \pi)$ comes from a realization of the quad-graph \mathcal{D} as a *rhombic ramified embedding* in \mathbb{C} . Flowers of such an embedding can wind around its vertices more than once.

Another formulation of the integrability conditions is given in terms of the *edges* of the rhombic realizations.

Theorem 5.6 *Integrability condition (5.9) for the weight function $\nu : E(\mathcal{G}) \sqcup E(\mathcal{G}^*) \rightarrow \mathbb{R}_+$ is equivalent to the following one: there exists a labeling $\theta : \vec{E}(\mathcal{D}) \rightarrow \mathbb{S}^1$ of directed edges of \mathcal{D} such that, in notations of Fig. 5.1,*

$$\nu(x_0, x_1) = \frac{1}{\nu(y_0, y_1)} = i \frac{\theta_0 - \theta_1}{\theta_0 + \theta_1}. \quad (5.14)$$

Under this condition, the 3D consistency of the discrete Cauchy-Riemann equations is assured by the following values of the weights ν on the diagonals of the vertical faces of \mathbf{D} :

$$\nu(x, y^+) = i \frac{\theta - \lambda}{\theta + \lambda}, \quad (5.15)$$

where $\theta = \theta(x, y)$, and $\lambda \in \mathbb{C}$ is an arbitrary number having the interpretation of the label carried by all vertical edges of \mathbf{D} : $\lambda = \theta(x, x^+) = \theta(y, y^+)$.

So, integrable discrete Cauchy-Riemann equations can be given a form with parameters attached to *directed* edges of \mathcal{D} :

$$\frac{f(y_1) - f(y_0)}{f(x_1) - f(x_0)} = \frac{\theta_1 - \theta_0}{\theta_1 + \theta_0}, \quad (5.16)$$

where

$$\theta_0 = p(y_0) - p(x_0) = p(x_1) - p(y_1), \quad \theta_1 = p(y_1) - p(x_0) = p(x_1) - p(y_0),$$

and $p : V(\mathcal{G}) \rightarrow \mathbb{C}$ is a rhombic realization of the quad-graph \mathcal{D} . Since

$$\frac{\theta_1 - \theta_0}{\theta_1 + \theta_0} = \frac{p(y_1) - p(y_0)}{p(x_1) - p(x_0)},$$

we see that for a discrete holomorphic function $f : V(\mathcal{G}) \rightarrow \mathbb{C}$, the quotient of diagonals of the f -image of any quadrilateral $(x_0, y_0, x_1, y_1) \in F(\mathcal{D})$ is equal to the quotient of diagonals of the corresponding rhombus.

A standard construction of zero curvature representation for 3D consistent equations, given in Theorem 4.3, leads in the present case to the following result.

Theorem 5.7 *The discrete Cauchy-Riemann equations (5.16) admit a zero curvature representation with spectral parameter dependent 2×2 matrices along $(x, y) \in \vec{E}(\mathcal{D})$ given by*

$$L(y, x, \alpha; \lambda) = \begin{pmatrix} \lambda + \theta & -2\theta(f(x) + f(y)) \\ 0 & \lambda - \theta \end{pmatrix}, \quad (5.17)$$

where $\theta = p(y) - p(x)$.

Linearity of the discrete Cauchy-Riemann equations is reflected in the triangular structure of the transition matrices.

Also, all constructions of Sect. 4.4 can be applied to integrable discrete Cauchy-Riemann equations. In particular, for weights coming from a quasicrystallic rhombic embedding of the quad-graph \mathcal{D} , with the labels $\Theta = \{\pm\theta_1, \dots, \pm\theta_d\}$, discrete holomorphic functions can be extended from the corresponding surface $\Omega_{\mathcal{D}} \subset \mathbb{Z}^d$ to its hull, preserving discrete holomorphy. Here we have in mind the following natural definition:

Definition 5.8 *A function $f : \mathbb{Z}^d \rightarrow \mathbb{C}$ is called **discrete holomorphic**, if it satisfies, on each elementary square of \mathbb{Z}^d , the equation*

$$\frac{f(\mathbf{n} + \mathbf{e}_j + \mathbf{e}_k) - f(\mathbf{n})}{f(\mathbf{n} + \mathbf{e}_j) - f(\mathbf{n} + \mathbf{e}_k)} = \frac{\theta_j + \theta_k}{\theta_j - \theta_k}. \quad (5.18)$$

For discrete holomorphic functions in \mathbb{Z}^d , the transition matrices along the edges $(\mathbf{n}, \mathbf{n} + \mathbf{e}_k)$ of \mathbb{Z}^d are given by

$$L_k(\mathbf{n}; \lambda) = \begin{pmatrix} \lambda + \theta_k & -2\theta_k(f(\mathbf{n} + \mathbf{e}_k) + f(\mathbf{n})) \\ 0 & \lambda - \theta_k \end{pmatrix}. \quad (5.19)$$

All observations of this section hold also in the case of generic complex weights ν , which leads to $\theta \in \mathbb{C}$ and to parallelogram realizations of \mathcal{D} .

5.4 Discrete exponential functions

A discrete exponential function on quad-graphs \mathcal{D} was defined and studied in [Me1, Ke]. Its definition, for a given rhombic embedding $p : V(\mathcal{D}) \rightarrow \mathbb{C}$, is as follows: fix a point $x_0 \in V(\mathcal{D})$. For any other point $x \in V(\mathcal{D})$, choose some path $\{\epsilon_j\}_{j=1}^n \subset \vec{E}(\mathcal{D})$ connecting x_0 to x , so that $\epsilon_j = (x_{j-1}, x_j)$ and $x_n = x$. Let the slope of the j th edge be $\theta_j = p(x_j) - p(x_{j-1}) \in \mathbb{S}^1$. Then

$$e(x; z) = \prod_{j=1}^n \frac{z + \theta_j}{z - \theta_j}.$$

Clearly, this definition depends on the choice of the point $x_0 \in V(\mathcal{D})$, but not on the path connecting x_0 to x . A question posed in [Ke] is whether discrete exponential functions form a basis in the space of discrete holomorphic functions on \mathcal{D} .

An extension of the discrete exponential function from $\Omega_{\mathcal{D}}$ to the whole of \mathbb{Z}^d is the *discrete exponential function*, given by the following simple formula:

$$e(\mathbf{n}; z) = \prod_{k=1}^d \left(\frac{z + \theta_k}{z - \theta_k} \right)^{n_k}. \quad (5.20)$$

For $d = 2$, this function was considered in [F, Do1]. The discrete Cauchy-Riemann equations for the discrete exponential function are easily checked: they are equivalent to a simple identity

$$\left(\frac{z + \theta_j}{z - \theta_j} \cdot \frac{z + \theta_k}{z - \theta_k} - 1 \right) / \left(\frac{z + \theta_j}{z - \theta_j} - \frac{z + \theta_k}{z - \theta_k} \right) = \frac{\theta_j + \theta_k}{\theta_j - \theta_k}.$$

At a given $\mathbf{n} \in \mathbb{Z}^d$, the discrete exponential function is rational with respect to the parameter z , with poles at the points $\epsilon_1\theta_1, \dots, \epsilon_d\theta_d$, where $\epsilon_k = \text{sign } n_k$.

Equivalently, one can identify the discrete exponential function by its initial values on the axes:

$$e(n\mathbf{e}_k; z) = \left(\frac{z + \theta_k}{z - \theta_k} \right)^n. \quad (5.21)$$

A still another characterization says that $e(\cdot; z)$ is the Bäcklund transformation of the zero solution of discrete Cauchy-Riemann equations on \mathbb{Z}^d , with the “vertical” parameter z .

We now show that the discrete exponential functions form a basis in some natural class of functions (growing not faster than exponentially), thus answering in affirmative the above mentioned question by Kenyon.

Theorem 5.9 *Let f be a discrete holomorphic function on $V(\mathcal{D}) \sim V(\Omega_{\mathcal{D}})$, satisfying*

$$|f(\mathbf{n})| \leq \exp(C(|n_1| + \dots + |n_d|)), \quad \forall \mathbf{n} \in V(\Omega_{\mathcal{D}}), \quad (5.22)$$

with some $C \in \mathbb{R}$. Extend it to a discrete holomorphic function on $\mathcal{H}(V(\Omega_{\mathcal{D}}))$. There exists a function g defined on the disjoint union of small neighborhoods around the points $\pm\theta_k \in \mathbb{C}$ and holomorphic on each one of these neighborhoods, such that

$$f(\mathbf{n}) - f(\mathbf{0}) = \frac{1}{2\pi i} \int_{\Gamma} g(\lambda) e(\mathbf{n}; \lambda) d\lambda, \quad \forall \mathbf{n} \in \mathcal{H}(V(\Omega_{\mathcal{D}})), \quad (5.23)$$

where Γ is a collection of $2d$ small loops, each one running counterclockwise around one of the points $\pm\theta_k$.

Proof is constructive and consists of three steps.

- (i) Extend f from $V(\Omega_{\mathcal{D}})$ to $\mathcal{H}(V(\Omega_{\mathcal{D}}))$; inequality (5.22) propagates in the extension process, if the constant C is chosen large enough.
- (ii) Introduce the restrictions $f_n^{(k)}$ of $f : \mathcal{H}(V(\Omega_{\mathcal{D}})) \rightarrow \mathbb{C}$ to the coordinate axes:

$$f_n^{(k)} = f(n\mathbf{e}_k), \quad a_k(\Omega_{\mathcal{D}}) \leq n \leq b_k(\Omega_{\mathcal{D}}).$$

- (iii) Set $g(\lambda) = \sum_{k=1}^d (g_k(\lambda) + g_{-k}(\lambda))$, where the functions $g_{\pm k}(\lambda)$ vanish everywhere except in small neighborhoods of the points $\pm\theta_k$, respectively, and are given there by convergent series

$$g_k(\lambda) = \frac{1}{2\lambda} \left(f_1^{(k)} - f(\mathbf{0}) + \sum_{n=1}^{\infty} \left(\frac{\lambda - \theta_k}{\lambda + \theta_k} \right)^n (f_{n+1}^{(k)} - f_{n-1}^{(k)}) \right), \quad (5.24)$$

and a similar formula for $g_{-k}(\lambda)$. Formula (5.23) is then easily verified by computing the residues at $\lambda = \pm\theta_k$.

It is important to observe that the data $f_n^{(k)}$, necessary for the construction of $g(\lambda)$, are *not among* the values of f on $V(\mathcal{D}) \sim V(\Omega_{\mathcal{D}})$ known initially, but are encoded in the extension process.

5.5 Discrete logarithmic function

The discrete logarithmic function on \mathcal{D} can be defined as follows [Ke]. Fix some point $x_0 \in V(\mathcal{D})$, and set

$$\ell(x) = \frac{1}{2\pi i} \int_{\Gamma} \frac{\log(\lambda)}{2\lambda} e(x; \lambda) d\lambda, \quad \forall x \in V(\mathcal{D}). \quad (5.25)$$

Here the integration path Γ is the same as in Theorem 5.9, and fixing x_0 is necessary for the definition of the discrete exponential function on \mathcal{D} . To make (5.25) a valid definition, one has to specify a branch of $\log(\lambda)$ in a neighborhood of each point $\pm\theta_k$. This choice depends on x , and is done as follows.

Assume, without loss of generality, that the circular order of the points $\pm\theta_k$ on the positively oriented unit circle \mathbb{S}^1 is the following: $\theta_1, \dots, \theta_d, -\theta_1, \dots, -\theta_d$. We set $\theta_{k+d} = -\theta_k$ for $k = 1, \dots, d$, and then define θ_r for all $r \in \mathbb{Z}$ by $2d$ -periodicity. For each $r \in \mathbb{Z}$, assign to $\theta_r = \exp(i\gamma_r) \in \mathbb{S}^1$ a certain value of argument $\gamma_r \in \mathbb{R}$: choose a value γ_1 of the argument of θ_1 arbitrarily, and then extend it according to the rule

$$\gamma_{r+1} - \gamma_r \in (0, \pi), \quad \forall r \in \mathbb{Z}.$$

Clearly, there holds $\gamma_{r+d} = \gamma_r + \pi$, and therefore also $\gamma_{r+2d} = \gamma_r + 2\pi$. It will be convenient to consider the points θ_r , supplied with the arguments γ_r , as belonging to the Riemann surface Λ of the logarithmic function (a branched covering of the complex λ -plane).

For each $m \in \mathbb{Z}$, define the ‘‘sector’’ U_m on the embedding plane \mathbb{C} of the quad-graph \mathcal{D} as the set of all points of $V(\mathcal{D})$ which can be reached from x_0 along paths with all edges from $\{\theta_m, \dots, \theta_{m+d-1}\}$. Two sectors U_{m_1} and U_{m_2} have a non-empty intersection, if and only if $|m_1 - m_2| < d$. The union $U = \bigcup_{m=-\infty}^{\infty} U_m$ is a branched covering of the quad-graph \mathcal{D} , and serves as the definition domain of the discrete logarithmic function.

The definition (5.25) of the latter should be read as follows: for $x \in U_m$, the poles of $e(x; \lambda)$ are exactly the points $\theta_m, \dots, \theta_{m+d-1} \in \Lambda$. The integration path Γ consists of d small loops on Λ around these points, and $\arg(\lambda) = \Im \log(\lambda)$ takes values in a small open neighborhood (in \mathbb{R}) of the interval

$$[\gamma_m, \gamma_{m+d-1}] \quad (5.26)$$

of length less than π . If m increases by $2d$, the interval (5.26) is shifted by 2π . As a consequence, the function ℓ is discrete holomorphic, and its

restriction to the “black” points $V(\mathcal{G})$ is discrete harmonic everywhere on U except at the point x_0 :

$$\Delta\ell(x) = \delta_{x_0x}. \quad (5.27)$$

Thus, the functions g_k in the integral representation (5.23) of an arbitrary discrete holomorphic function, defined originally in disjoint neighborhoods of the points α_r , in the case of the discrete logarithmic function are actually restrictions of a single analytic function $\log(\lambda)/(2\lambda)$ to these neighborhoods. This allows one to deform the integration path Γ into a connected contour lying on a single leaf of the Riemann surface of the logarithm, and then to use standard methods of the complex analysis in order to obtain asymptotic expressions for the discrete logarithmic function. In particular, one can show [Ke] that at the “black” points $V(\mathcal{G})$ there holds:

$$\ell(x) \sim \log|x - x_0|, \quad x \rightarrow \infty. \quad (5.28)$$

Properties (5.27), (5.28) characterize the *discrete Green’s function* on \mathcal{G} . Thus:

Theorem 5.10 *The discrete logarithmic function on \mathcal{D} , restricted to the set of vertices $V(\mathcal{G})$ of the “black” graph \mathcal{G} , coincides with discrete Green’s function on \mathcal{G} .*

Now we extend the discrete logarithmic function to \mathbb{Z}^d , which will allow us to gain significant additional information about it [BobMeS]. Introduce, in addition to the unit vectors $e_k \in \mathbb{Z}^d$ (corresponding to $\theta_k \in \mathbb{S}^1$), their opposites $e_{k+d} = -e_k$, $k \in [1, d]$ (corresponding to $\theta_{k+d} = -\theta_k$), and then define e_r for all $r \in \mathbb{Z}$ by $2d$ -periodicity. Then

$$S_m = \bigoplus_{r=m}^{m+d-1} \mathbb{Z}e_r \subset \mathbb{Z}^d \quad (5.29)$$

is a d -dimensional octant containing exactly the part of $\Omega_{\mathcal{D}}$ which is the P -image of the sector $U_m \subset \mathcal{D}$. Clearly, only $2d$ different octants appear among S_m (out of 2^d possible d -dimensional octants). Define \tilde{S}_m as the octant S_m equipped with the interval (5.26) of values for $\Im \log(\theta_r)$. By definition, \tilde{S}_{m_1} and \tilde{S}_{m_2} intersect, if the underlying octants S_{m_1} and S_{m_2} have a non-empty intersection spanned by the common coordinate semi-axes $\mathbb{Z}e_r$, and $\Im \log(\theta_r)$ for these common semi-axes match. It is easy to see that \tilde{S}_{m_1} and \tilde{S}_{m_2} intersect, if and only if $|m_1 - m_2| < d$. The union $\tilde{S} = \bigcup_{m=-\infty}^{\infty} \tilde{S}_m$ is a branched covering of the set $\bigcup_{m=1}^{2d} S_m \subset \mathbb{Z}^d$.

Definition 5.11 The *discrete logarithmic function* on \tilde{S} is given by the formula

$$\ell(\mathbf{n}) = \frac{1}{2\pi i} \int_{\Gamma} \frac{\log(\lambda)}{2\lambda} e(\mathbf{n}; \lambda) d\lambda, \quad \forall \mathbf{n} \in \tilde{S}, \quad (5.30)$$

where for $\mathbf{n} \in \tilde{S}_m$ the integration path Γ consists of d loops around $\theta_m, \dots, \theta_{m+d-1}$ on Λ , and $\Im \log(\lambda)$ on Γ is chosen in a small open neighborhood of the interval (5.26).

The discrete logarithmic function on \mathcal{D} can be described as the restriction of the discrete logarithmic function on \tilde{S} to a branched covering of $\Omega_{\mathcal{D}} \sim \mathcal{D}$. This holds for an *arbitrary* quasicrystalline quad-graph \mathcal{D} whose set of edge slopes coincides with $\Theta = \{\pm\theta_1, \dots, \pm\theta_d\}$.

Now we are in a position to give an alternative definition of the discrete logarithmic function. Clearly, it is completely characterized by its values $\ell(\mathbf{n}\mathbf{e}_r)$, $r \in [m, m+d-1]$, on the coordinate semi-axes of an arbitrary octant \tilde{S}_m . Let us stress once more that the points $\mathbf{n}\mathbf{e}_r$ do not lie, in general, on the original quad-surface $\Omega_{\mathcal{D}}$.

Theorem 5.12 The values $\ell_n^{(r)} = \ell(\mathbf{n}\mathbf{e}_r)$, $r \in [m, m+d-1]$, of the discrete logarithmic function on $\tilde{S}_m \subset \tilde{S}$ are given by:

$$\ell_n^{(r)} = \begin{cases} 2\left(1 + \frac{1}{3} + \dots + \frac{1}{n-1}\right), & n \text{ even,} \\ \log(\theta_r) = i\gamma_r, & n \text{ odd.} \end{cases} \quad (5.31)$$

Here the values $\log(\theta_r) = i\gamma_r$ are chosen in the interval (5.26).

Proof. Comparing formula (5.30) with (5.24), we see that the values $\ell_n^{(r)}$ can be obtained from the expansion of $\log(\lambda)$ in a neighbourhood of $\lambda = \theta_r$ into the power series with respect to the powers of $(\lambda - \theta_r)/(\lambda + \theta_r)$. This expansion reads:

$$\log(\lambda) = \log(\theta_r) + \sum_{n=1}^{\infty} \frac{1 - (-1)^n}{n} \left(\frac{\lambda - \theta_r}{\lambda + \theta_r}\right)^n.$$

Thus, we come to a simple difference equation

$$n(\ell_{n+1}^{(r)} - \ell_{n-1}^{(r)}) = 1 - (-1)^n, \quad (5.32)$$

with the initial conditions

$$\ell_0^{(r)} = \ell(\mathbf{0}) = 0, \quad \ell_1^{(r)} = \ell(\mathbf{e}_r) = \log(\theta_r), \quad (5.33)$$

which yields eq. (5.31). \square

Observe that values (5.31) at even (resp. odd) points imitate the behaviour of the real (resp. imaginary) part of the function $\log(\lambda)$ along the semi-lines $\arg(\lambda) = \arg(\theta_r)$. This can be easily extended to the whole of \tilde{S} . Restricted to black points $\mathbf{n} \in \tilde{S}$ (those with $n_1 + \dots + n_d$ even), the discrete logarithmic function models the real part of the logarithm. In particular, it is real-valued and does not branch: its values on \tilde{S}_m depend on $m \pmod{2d}$ only. In other words, it is a well defined function on S_m . On the contrary, the discrete logarithmic function restricted to white points $\mathbf{n} \in \tilde{S}$ (those with $n_1 + \dots + n_d$ odd) takes purely imaginary values, and increases by $2\pi i$, as m increases by $2d$. Hence, this restricted function models the imaginary part of the logarithm.

It turns out that recurrent relations (5.32) are characteristic for an important class of solutions of the discrete Cauchy-Riemann equations, namely for the *isomonodromic* ones. In order to introduce this class, recall that discrete holomorphic functions in \mathbb{Z}^d possess a zero curvature representation with the transition matrices (5.19). The *moving frame* $\Psi(\cdot, \lambda) : \mathbb{Z}^d \rightarrow GL_2(\mathbb{C})[\lambda]$ is defined by prescribing some $\Psi(\mathbf{0}; \lambda)$, and by extending it recurrently according to the formula

$$\Psi(\mathbf{n} + \mathbf{e}_k; \lambda) = L_k(\mathbf{n}; \lambda)\Psi(\mathbf{n}; \lambda). \quad (5.34)$$

Finally, define the matrices $A(\cdot; \lambda) : \mathbb{Z}^d \rightarrow GL_2(\mathbb{C})[\lambda]$ by

$$A(\mathbf{n}; \lambda) = \frac{d\Psi(\mathbf{n}; \lambda)}{d\lambda}\Psi^{-1}(\mathbf{n}; \lambda). \quad (5.35)$$

These matrices satisfy a recurrent relation, which results by differentiating (5.34),

$$A(\mathbf{n} + \mathbf{e}_k; \lambda) = \frac{dL_k(\mathbf{n}; \lambda)}{d\lambda}L_k^{-1}(\mathbf{n}; \lambda) + L_k(\mathbf{n}; \lambda)A(\mathbf{n}; \lambda)L_k^{-1}(\mathbf{n}; \lambda), \quad (5.36)$$

and therefore they are defined uniquely after fixing some $A(\mathbf{0}; \lambda)$.

Definition 5.13 *A discrete holomorphic function $f : \mathbb{Z}^d \rightarrow \mathbb{C}$ is called **isomonodromic**, if, for some choice of $A(\mathbf{0}; \lambda)$, the matrices $A(\mathbf{n}; \lambda)$ are meromorphic in λ , with poles whose positions and orders do not depend on $\mathbf{n} \in \mathbb{Z}^d$.*

This term originates in the theory of integrable nonlinear differential equations, where it is used for solutions with a similar analytic characterization [IN].

It is clear how to extend Definition 5.13 to functions on the covering \tilde{S} . In the following statement, we restrict ourselves to the octant $S_1 = (\mathbb{Z}_+)^d$ for notational simplicity.

Theorem 5.14 *The discrete logarithmic function is isomonodromic: for a proper choice of $A(\mathbf{0}; \lambda)$, the matrices $A(\mathbf{n}; \lambda)$ at any point $\mathbf{n} \in (\mathbb{Z}_+)^d$ have simple poles only:*

$$A(\mathbf{n}; \lambda) = \frac{A^{(0)}(\mathbf{n})}{\lambda} + \sum_{l=1}^d \left(\frac{B^{(l)}(\mathbf{n})}{\lambda + \theta_l} + \frac{C^{(l)}(\mathbf{n})}{\lambda - \theta_l} \right), \quad (5.37)$$

with

$$A^{(0)}(\mathbf{n}) = \begin{pmatrix} 0 & (-1)^{n_1 + \dots + n_d} \\ 0 & 0 \end{pmatrix}, \quad (5.38)$$

$$B^{(l)}(\mathbf{n}) = n_l \begin{pmatrix} 1 & -(\ell(\mathbf{n}) + \ell(\mathbf{n} - \mathbf{e}_l)) \\ 0 & 0 \end{pmatrix}, \quad (5.39)$$

$$C^{(l)}(\mathbf{n}) = n_l \begin{pmatrix} 0 & \ell(\mathbf{n} + \mathbf{e}_l) + \ell(\mathbf{n}) \\ 0 & 1 \end{pmatrix}. \quad (5.40)$$

At any point $\mathbf{n} \in \tilde{S}$, the following constraint holds:

$$\sum_{l=1}^d n_l \left(\ell(\mathbf{n} + \mathbf{e}_l) - \ell(\mathbf{n} - \mathbf{e}_l) \right) = 1 - (-1)^{n_1 + \dots + n_d}. \quad (5.41)$$

Proof. The proper choice of $A(\mathbf{0}; \lambda)$ mentioned in the Theorem, can be read off formula (5.38): $A(\mathbf{0}; \lambda) = \frac{1}{\lambda} \begin{pmatrix} 0 & 1 \\ 0 & 0 \end{pmatrix}$. The proof consists of two parts.

- (i) First, one proves the claim for the points of the coordinate semi-axes. For any $r = 1, \dots, d$, construct the matrices $A(n\mathbf{e}_r; \lambda)$ along the r -th coordinate semi-axis via formula (5.36) with the transition matrices (5.19). This formula shows that singularities of $A(n\mathbf{e}_r; \lambda)$ are poles at $\lambda = 0$ and at $\lambda = \pm\theta_r$, and that the pole $\lambda = 0$ remains simple for all $n > 0$. By a direct computation and using mathematical induction, one shows that it is exactly the recurrent relation (5.32) for $f_n^{(r)} = f(n\mathbf{e}_r)$ that assures the poles $\lambda = \pm\theta_r$ to remain simple for all $n > 0$. Thus, eq. (5.37) holds on the r -th coordinate semi-axis, with $B^{(l)}(n\mathbf{e}_r) = C^{(l)}(n\mathbf{e}_r) = 0$ for $l \neq r$.

- (ii) The second part of the proof is conceptual, and is based upon the multidimensional consistency only. Proceed by induction, whose scheme follows filling out the hull of the coordinate semi-axes: each new point is of the form $\mathbf{n} + \mathbf{e}_j + \mathbf{e}_k$, $j \neq k$, with three points \mathbf{n} , $\mathbf{n} + \mathbf{e}_j$ and $\mathbf{n} + \mathbf{e}_k$ known from the previous steps, where the statements of the proposition are assumed to hold. Suppose that (5.37) holds at $\mathbf{n} + \mathbf{e}_j$, $\mathbf{n} + \mathbf{e}_k$. The new matrix $A(\mathbf{n} + \mathbf{e}_j + \mathbf{e}_k; \lambda)$ is obtained by two alternative formulas,

$$A(\mathbf{n} + \mathbf{e}_j + \mathbf{e}_k; \lambda) = \frac{dL_k(\mathbf{n} + \mathbf{e}_j; \lambda)}{d\lambda} L_k^{-1}(\mathbf{n} + \mathbf{e}_j; \lambda) + L_k(\mathbf{n} + \mathbf{e}_j; \lambda) A(\mathbf{n} + \mathbf{e}_j; \lambda) L_k^{-1}(\mathbf{n} + \mathbf{e}_j; \lambda), \quad (5.42)$$

and the one with interchanged roles of k and j . Eq. (5.42) shows that all poles of $A(\mathbf{n} + \mathbf{e}_j + \mathbf{e}_k; \lambda)$ remain simple, with the possible exception of $\lambda = \pm\theta_k$, whose orders might increase by 1. The same statement holds with k replaced by j . Therefore, *all* poles remain simple, and (5.37) holds at $\mathbf{n} + \mathbf{e}_j + \mathbf{e}_k$. Formulas (5.38)–(5.40) and constraint (5.41) follow by direct computations based on eq. (5.42). \square

Chapter 6

Discrete complex analysis. Integrable circle patterns

6.1 Circle patterns

The idea that circle packings and, more generally, circle patterns serve as a discrete counterpart of analytic functions is by now well established, see a popular review [St1] and a monograph [St2]. The origin of this idea is connected with Thurston's approach to the Riemann mapping theorem via circle packings, see [Th1]. Since then the theory bifurcated to several areas.

One of them is mainly dealing with approximation problems, and in this context it is advantageous to stick from the beginning with some fixed regular combinatorics. The most popular are hexagonal packings, for which the C^∞ convergence to the Riemann mapping has been established [RSu, HeS]. Similar results are available also for circle patterns with the combinatorics of the square grid introduced by Schramm [Schr].

Another area concentrates around the uniformization theorem of Koebe-Andreev-Thurston, and is dealing with circle packing realizations of cell complexes of prescribed combinatorics, rigidity properties, constructing hyperbolic 3-manifolds, etc. [Th2, MR, BeaS, He]. A new variational approach to this area is given in [BobSp], where also a review of related results can be found. An important differential-geometric application of this approach is the construction of discrete minimal surfaces through circle patterns [BobHoSp].

The Schramm circle patterns with the combinatorics of the square grid constitute also a prominent example in the area we are mainly interested here, which deals with the interrelations of circle patterns with integrable

systems. We give here a presentation of several results in this area, based on [BobP3, BobHo, AgB1].

Definition 6.1 *Let \mathcal{G} be an arbitrary cell decomposition of an open or closed disk in \mathbb{C} . A map $z : V(\mathcal{G}) \mapsto \mathbb{C}$ defines a **circle pattern with the combinatorics of \mathcal{G}** , if the following condition is satisfied. Let $y \in F(\mathcal{G}) \sim V(\mathcal{G}^*)$ be an arbitrary face of \mathcal{G} , and let x_1, x_2, \dots, x_n be its consecutive vertices. Then the points $z(x_1), z(x_2), \dots, z(x_n) \in \mathbb{C}$ lie on a circle, and their circular order is just the listed one. We denote this circle by $C(y)$, thus putting it into a correspondence with the face y , or, equivalently, with the respective vertex of the dual cell decomposition \mathcal{G}^* .*

As a consequence of this condition, if two faces $y_0, y_1 \in F(\mathcal{G})$ have a common edge (x_0, x_1) , then the circles $C(y_0)$ and $C(y_1)$ intersect in the points $z(x_1), z(x_2)$. In other words, the edges from $E(\mathcal{G})$ correspond to pairs of neighboring (intersecting) circles of the pattern. Similarly, if several faces $y_1, y_2, \dots, y_m \in F(\mathcal{G})$ meet in one point $x_0 \in V(\mathcal{G})$, then the corresponding circles $C(y_1), C(y_2), \dots, C(y_m)$ also have a common intersection point $z(x_0)$.

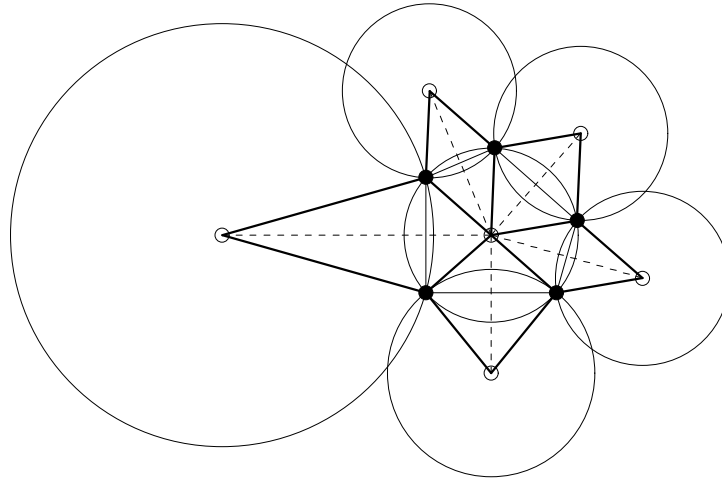

Figure 6.1: Circle pattern

Given a circle pattern with the combinatorics of \mathcal{G} , we can extend the

function z to the vertices of the dual graph, setting

$$z(y) = \text{center of the circle } C(y), \quad y \in F(\mathcal{G}) \simeq V(\mathcal{G}^*).$$

After this extension, the map z is defined on all of $V(\mathcal{D}) = V(\mathcal{G}) \sqcup V(\mathcal{G}^*)$, where \mathcal{D} is the double of \mathcal{G} . Consider a face of the double. Its z -image is a quadrilateral of the *kite* form, whose vertices correspond to the intersection points and the centers of two neighboring circles C_0, C_1 of the pattern. Denote the radii of C_0, C_1 by r_0, r_1 , respectively. Let x_0, x_1 correspond to the intersection points, and let y_0, y_1 correspond to the centers of the circles. Give the circles C_0, C_1 a positive orientation (induced by the orientation of the underlying \mathbb{C}), and let $\phi \in (0, \pi)$ stand for the intersection angle of these oriented circles. This angle ϕ is equal to the kite angles at the “black” vertices $z(x_0), z(x_1)$, see Fig. 6.2, where the complementary angle $\phi^* = \pi - \phi$ is also shown. It will be convenient to assign the intersection angle $\phi = \phi(e)$ to the “black” edge $e = (x_0, x_1) \in E(\mathcal{G})$, and to assign the complementary angle $\phi^* = \phi(e^*)$ to the dual “white” edge $e^* = (y_0, y_1) \in E(\mathcal{G}^*)$. Thus, the function $\phi : E(\mathcal{G}) \sqcup E(\mathcal{G}^*) \rightarrow (0, \pi)$ satisfies eq. (5.11).

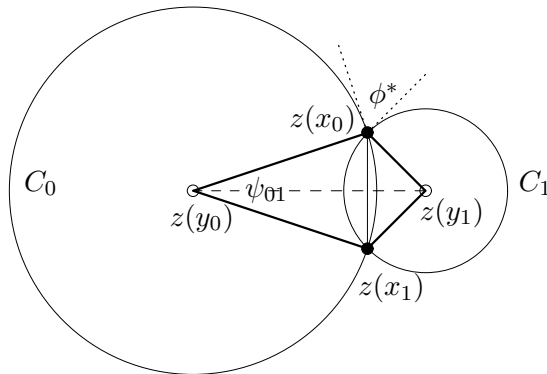

Figure 6.2: Two intersecting circles

The geometry of Fig. 6.2 yields following relations. First of all, the cross-ratio of the four points corresponding to the vertices of a quadrilateral face of \mathcal{D} is expressed through the intersection angle of the circles C_0, C_1 :

$$q(z(x_0), z(y_0), z(x_1), z(y_1)) = \exp(2i\phi^*). \quad (6.1)$$

Further, running around a “black” vertex of \mathcal{D} (a common intersection point of several circles of the pattern), we see that the sum of the consecutive kite

angles vanishes (mod 2π), hence:

$$\prod_{e \in \text{star}(x_0; \mathcal{G})} \exp(i\phi(e)) = 1, \quad \forall x_0 \in V(\mathcal{G}). \quad (6.2)$$

Finally, let ψ_{01} be the angle of the kite $(z(x_0), z(y_0), z(x_1), z(y_1))$ at the “white” vertex $z(y_0)$, i.e., the angle between the half-lines from the center $z(y_0)$ of the circle C_0 to the intersection points $z(x_0), z(x_1)$ with its circle C_1 . It is not difficult to calculate this angle:

$$\exp(i\psi_{01}) = \frac{r_0 + r_1 \exp(i\phi^*)}{r_0 + r_1 \exp(-i\phi^*)}. \quad (6.3)$$

Running around the “white” vertex of \mathcal{D} , we come to the relation

$$\prod_{j=1}^m \frac{r_0 + r_j \exp(i\phi_j^*)}{r_0 + r_j \exp(-i\phi_j^*)} = 1, \quad \forall y_0 \in V(\mathcal{G}^*), \quad (6.4)$$

where the product is extended over all edges $e_j^* = (y_0, y_j) \in \text{star}(y_0; \mathcal{G}^*)$, and $\phi_j^* = \phi(e_j^*)$, while r_j are the radii of the circles $C_j = C(y_j)$. This formula has been used in [BobSp] as the basis of a variational proof of the existence and uniqueness of Delaunay circle patterns with prescribed combinatorics and intersection angles.

6.2 Integrable cross-ratio and Hirota systems

Our main interest is in the circle patterns with prescribed combinatorics and with prescribed intersection angles for all pairs of neighboring angles. (This is not the only class of patterns deserving a study from the point of view of integrability, see, e.g., [BobHoSu] for a different integrable class.) According to eq. (6.1), prescribing all intersection angles amounts to prescribing cross-ratios for all quadrilateral faces of the quad-graph \mathcal{D} . Thus, we come to the study of cross-ratio equations on arbitrary quad-graphs.

Let there be given a function $Q : E(\mathcal{G}) \sqcup E(\mathcal{G}^*) \rightarrow \mathbb{C}$ satisfying the condition

$$Q(e^*) = 1/Q(e), \quad \forall e \in E(\mathcal{G}). \quad (6.5)$$

Definition 6.2 *The **cross-ratio system** on \mathcal{D} corresponding to the function Q , consists of the following equations for a function $z : V(\mathcal{D}) \rightarrow \mathbb{C}$, one for any quadrilateral face (x_0, y_0, x_1, y_1) of \mathcal{D} :*

$$q(z(x_0), z(y_0), z(x_1), z(y_1)) = Q(x_0, x_1) = 1/Q(y_0, y_1). \quad (6.6)$$

An important distinction from the discrete Cauchy-Riemann equations is that the cross-ratio equations actually do not feel the orientation of quadrilaterals.

We have already encountered 3D consistent cross-ratio systems on \mathbb{Z}^d in Sect. 4.1 (see eq. (4.1)), in the version with labelled edges. A natural generalization to the case of arbitrary quad-graphs is this:

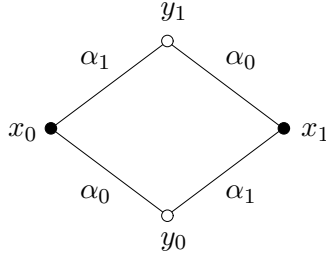

Figure 6.3: Quadrilateral, with a labelling of undirected edges

Definition 6.3 A cross-ratio system is called *integrable*, if there exists a labelling $\alpha : E(\mathcal{D}) \rightarrow \mathbb{C}$ of undirected edges of \mathcal{D} such that the function Q admits the following factorization (in notations of Fig. 6.3):

$$Q(x_0, x_1) = \frac{1}{Q(y_0, y_1)} = \frac{\alpha_0}{\alpha_1}. \tag{6.7}$$

Clearly, integrable cross-ratio systems are 3D consistent (see Theorem 2.28), admit *Bäcklund transformations*, and possess *zero curvature representation* with the transition matrices (4.14). It is not difficult to give an equivalent re-formulation of the integrability condition (6.7).

Theorem 6.4 A cross-ratio system with the function $Q : E(\mathcal{G}) \sqcup E(\mathcal{G}^*) \rightarrow \mathbb{C}$ is integrable, if and only if for all $x_0 \in V(\mathcal{G})$ and for all $y_0 \in V(\mathcal{G}^*)$ the following conditions are fulfilled:

$$\prod_{e \in \text{star}(x_0; \mathcal{G})} Q(e) = 1, \quad \prod_{e^* \in \text{star}(y_0; \mathcal{G}^*)} Q(e^*) = 1. \tag{6.8}$$

For a labelling of undirected edges $\alpha : E(\mathcal{D}) \rightarrow \mathbb{C}$, there can be found a labelling $\theta : \vec{E}(\mathcal{D}) \rightarrow \mathbb{C}$ of directed edges such that $\alpha = \theta^2$. The function $p : V(\mathcal{D}) \rightarrow \mathbb{C}$ defined by $p(y) - p(x) = \theta(x, y)$ gives, according to eq. (6.8), a parallelogram realization (ramified embedding) of the quad-graph \mathcal{D} . The

cross-ratio equations are written as

$$q(z(x_0), z(y_0), z(x_1), z(y_1)) = \frac{\theta_0^2}{\theta_1^2} = q(p(x_0), p(y_0), p(x_1), p(y_1)), \quad (6.9)$$

in other words, the cross-ratio of the vertices of the f -image of any quadrilateral $(x_0, y_0, x_1, y_1) \in F(\mathcal{D})$ is equal to the cross-ratio of the vertices of the corresponding parallelogram. In particular, one always has the *trivial* solution $z(x) \equiv p(x)$ for all $x \in V(\mathcal{D})$.

A very useful transformation of the cross-ratio system is given by the following construction.

Definition 6.5 *The **Hirota system** for a given labelling of directed edges $\theta : \vec{E}(\mathcal{D}) \rightarrow \mathbb{C}$ consists of the following equations for the function $w : V(\mathcal{D}) \rightarrow \mathbb{C}$, one for every quadrilateral face $(x_0, y_0, x_1, y_1) \in F(\mathcal{D})$:*

$$\theta_0 w(x_0)w(y_0) + \theta_1 w(y_0)w(x_1) - \theta_0 w(x_1)w(y_1) - \theta_1 w(y_1)w(x_0) = 0. \quad (6.10)$$

Note that this Hirota system is different from eq. (4.3) of Sect. 4.1, in that the present version has parameters defined on *directed* edges. In terms of the parallelogram realization $p : V(\mathcal{D}) \rightarrow \mathbb{C}$ of the quad-graph \mathcal{D} corresponding to the labelling θ , eq. (6.10) reads:

$$\begin{aligned} w(x_0)w(y_0)(p(y_0) - p(x_0)) + w(y_0)w(x_1)(p(x_1) - p(y_0)) + \\ w(x_1)w(y_1)(p(y_1) - p(x_1)) + w(y_1)w(x_0)(p(x_0) - p(y_1)) = 0. \end{aligned} \quad (6.11)$$

Obviously, a transformation $w \rightarrow cw$ on $V(\mathcal{G})$ and $w \rightarrow c^{-1}w$ on $V(\mathcal{G}^*)$ with a constant $c \in \mathbb{C}$, called hereafter a black-white scaling, maps solutions of the Hirota system into solutions. A relation between the cross-ratio and the Hirota system is based on the following observation:

Theorem 6.6 *Let $w : V(\mathcal{D}) \rightarrow \mathbb{C}$ be a solution of the Hirota system. Then the relation*

$$z(y) - z(x) = \theta(x, y)w(x)w(y) = w(x)w(y)(p(y) - p(x)) \quad (6.12)$$

for all directed edges $(x, y) \in \vec{E}(\mathcal{D})$ correctly defines a unique (up to an additive constant) function $z : V(\mathcal{D}) \rightarrow \mathbb{C}$ which is a solution of the cross-ratio system (6.9). Conversely, for any solution z of the cross-ratio system (6.9), relation (6.12) defines a function $w : V(\mathcal{D}) \rightarrow \mathbb{C}$ correctly and uniquely (up to a black-white scaling); this function w solves the Hirota system (6.10).

In particular, the trivial solution $z(x) = p(x)$ of the cross-ratio system corresponds to the trivial solution of the Hirota system, $w(x) \equiv 1$ for all $x \in V(\mathcal{D})$. By a direct computation one can establish the following fundamental property.

Theorem 6.7 *The Hirota system (6.10) is 3D consistent.*

As a usual consequence, the Hirota system admits Bäcklund transformations and possesses zero curvature representation with transition matrices along the edge $(x, y) \in \vec{E}(\mathcal{D})$ given by

$$L(y, x, \theta; \lambda) = \begin{pmatrix} 1 & -\theta w(y) \\ -\lambda\theta/w(x) & w(y)/w(x) \end{pmatrix}, \quad \text{where } \theta = p(y) - p(x). \quad (6.13)$$

6.3 Integrable circle patterns

Returning to circle patterns, let $\{z(x) : x \in V(\mathcal{G})\}$ be intersection points of the circles of a pattern, and let $\{z(y) : y \in V(\mathcal{G}^*)\}$ be their centers. Due to eq. (6.1), the function $z : V(\mathcal{D}) \rightarrow \mathbb{C}$ satisfies a cross-ratio system with $Q : E(\mathcal{G}) \sqcup E(\mathcal{G}^*) \rightarrow \mathbb{S}^1$ defined as $Q(e) = \exp(2i\phi(e))$. Because of eq. (6.2), the first one of the integrability conditions (6.8) is fulfilled for an *arbitrary* circle pattern. Therefore, integrability of the cross-ratio system for circle patterns with the prescribed intersection angles $\phi : E(\mathcal{G}^*) \rightarrow (0, \pi)$ is equivalent to:

$$\prod_{e^* \in \text{star}(y_0; \mathcal{G}^*)} \exp(2i\phi(e^*)) = 1, \quad \forall y_0 \in V(\mathcal{G}^*), \quad (6.14)$$

This is equivalent to the existence of the edge labelling $\alpha : E(\mathcal{D}) \rightarrow \mathbb{C}$ such that, in notations of Fig. 6.2,

$$\exp(2i\phi^*) = \frac{\alpha_0}{\alpha_1}. \quad (6.15)$$

Moreover, one can assume that the labelling α takes values in \mathbb{S}^1 .

Our definition of integrable circle patterns will require somewhat more than integrability of the corresponding cross-ratio system.

Definition 6.8 *A circle pattern with the prescribed intersection angles $\phi : E(\mathcal{G}^*) \rightarrow (0, \pi)$ is called **integrable**, if*

$$\prod_{e^* \in \text{star}(y_0; \mathcal{G}^*)} \exp(i\phi(e^*)) = 1, \quad \forall y_0 \in V(\mathcal{G}^*), \quad (6.16)$$

i.e., if for any circle of the pattern the sum of its intersection angles with all neighboring circles vanishes (mod 2π).

This requirement is equivalent to a somewhat sharper factorization than (6.15), namely, to the existence of a labelling of directed edges $\theta : \vec{E}(\mathcal{D}) \rightarrow \mathbb{S}^1$ such that, in notations of Fig. 6.2,

$$\exp(i\phi) = \frac{\theta_1}{\theta_0} \Leftrightarrow \exp(i\phi^*) = -\frac{\theta_0}{\theta_1}. \quad (6.17)$$

(Of course, the last condition yields (6.15) with $\alpha = \theta^2$.) The parallelogram realization $p : V(\mathcal{D}) \rightarrow \mathbb{C}$ corresponding to the labelling $\theta \in \mathbb{S}^1$ is actually a *rhombic* one.

Theorem 6.9 *Combinatorial data \mathcal{G} and intersection angles $\phi : E(\mathcal{G}) \rightarrow (0, \pi)$ belong to an integrable circle pattern, if and only if they admit an isoradial realization. In this case, the dual combinatorial data \mathcal{G}^* and intersection angles $\phi : E(\mathcal{G}^*) \rightarrow (0, \pi)$ admit a realization as an isoradial circle pattern, as well.*

Proof. The rhombic realization $p : V(\mathcal{D}) \rightarrow \mathbb{C}$ of the quad-graph \mathcal{D} corresponds to a circle pattern with the same combinatorics and the same intersection angles as the original one and with all radii equal to 1, and, simultaneously, to an analogous dual circle pattern. \square

Consider a rhombic realization $p : V(\mathcal{D}) \rightarrow \mathbb{C}$ of \mathcal{D} . Solutions $z : V(\mathcal{D}) \rightarrow \mathbb{C}$ of the corresponding integrable cross-ratio system which come from integrable circle patterns are characterized by the property that the z -image of any quadrilateral (x_0, y_0, x_1, y_1) from $F(\mathcal{D})$ is a *kite* with the prescribed angle ϕ at the black vertices $z(x_0), z(x_1)$ (cf. Fig. 6.2). It turns out that the description of this class of kite solutions admits a more convenient analytic characterization in terms of the corresponding solutions $w : V(\mathcal{D}) \rightarrow \mathbb{C}$ of the Hirota system defined by eq. (6.12).

Theorem 6.10 *The solution z of the cross-ratio system corresponds to a circle pattern, if and only if the solution w of the Hirota system, corresponding to z via (6.12), satisfies the condition*

$$w(x) \in \mathbb{S}^1, \quad w(y) \in \mathbb{R}_+, \quad \forall x \in V(\mathcal{G}), \quad y \in V(\mathcal{G}^*). \quad (6.18)$$

The values $w(y) \in \mathbb{R}_+$ have then the interpretation of the radii of the circles $C(y)$, while the (arguments of the) values $w(x) \in \mathbb{S}^1$ measure the rotation of the tangents to the circles intersecting at $z(x)$ with respect to the isoradial realization of the pattern.

Proof. As easily seen, the kite conditions are equivalent to:

$$\frac{|w(x_0)|}{|w(x_1)|} = 1 \quad \text{and} \quad \frac{w(y_0)}{w(y_1)} \in \mathbb{R}_+.$$

This yields (6.18), possibly upon a black-white scaling. \square

The conditions (6.18) form an *admissible reduction* of the Hirota system with $\theta \in \mathbb{S}^1$, in the following sense: if any three of the four points $w(x_0)$, $w(y_0)$, $w(x_1)$, $w(y_1)$ satisfy the condition (6.18), then so does the fourth one. This is immediately seen, if one rewrites the Hirota equation (6.10) in one of the equivalent forms:

$$\frac{w(x_1)}{w(x_0)} = \frac{\theta_1 w(y_1) - \theta_0 w(y_0)}{\theta_1 w(y_0) - \theta_0 w(y_1)} \quad \Leftrightarrow \quad \frac{w(y_1)}{w(y_0)} = \frac{\theta_0 w(x_0) + \theta_1 w(x_1)}{\theta_0 w(x_1) + \theta_1 w(x_0)}. \quad (6.19)$$

As a consequence of this remark, we obtain Bäcklund transformations for integrable circle patterns.

Theorem 6.11 *Let all $\theta \in \mathbb{S}^1$, and let $p : V(\mathcal{D}) \rightarrow \mathbb{C}$ be the corresponding rhombic realization of \mathcal{D} . Let the solution $w : V(\mathcal{D}) \rightarrow \mathbb{C}$ of the Hirota system correspond to a circle pattern with the combinatorics of \mathcal{G} , i.e., satisfy (6.18). Consider its Bäcklund transformation $w^+ : V(\mathcal{D}) \rightarrow \mathbb{C}$ with an arbitrary parameter $\lambda \in \mathbb{S}^1$ and with an arbitrary initial value $w^+(x_0) \in \mathbb{R}_+$ or $w^+(y_0) \in \mathbb{S}^1$. Then there holds:*

$$w^+(x) \in \mathbb{R}_+, \quad w^+(y) \in \mathbb{S}^1, \quad \forall x \in V(\mathcal{G}), \quad y \in V(\mathcal{G}^*), \quad (6.20)$$

so that w^+ corresponds to a circle pattern with the combinatorics of \mathcal{G}^* , which we call a Bäcklund transform of the original circle pattern.

We close this section by mentioning several Laplace type equations which can be used to describe integrable circle patterns. First of all, the restriction of the function z to $V(\mathcal{G})$ (i.e., the intersection points of the circles) satisfies the equations

$$\sum_{k=1}^n \frac{\alpha_k - \alpha_{k+1}}{z(x_k) - z(x_0)} = 0.$$

Here $z(x_0)$ is any intersection point, where n circles $C(y_1), \dots, C(y_n)$ meet, $z(x_k)$ are the second intersection points of $C(y_k)$ with $C(y_{k+1})$, and α_k are the labels on the edges $(x_0, y_k) \in E(\mathcal{D})$. Analogously, the restriction of the function z to $V(\mathcal{G}^*)$ (i.e., the centers of the circles) satisfies the equation

$$\sum_{j=1}^m \frac{\alpha_{j-1} - \alpha_j}{z(y_j) - z(y_0)} = 0.$$

Here $z(y_0)$ is the center of any circle $C(y_0)$, which intersects with m circles $C(y_1), \dots, C(y_m)$ with the centers at the points $z(y_j)$; the intersection of $C(y_0)$ with $C(y_j)$ consists of two points $z(x_{j-1}), z(x_j)$, and α_j are the labels on the edges $(y_0, x_j) \in E(\mathcal{D})$. These both Laplace type equations follow from the first claim of Theorem 4.14, applied to the cross-ratio system, which is nothing but the case $(Q1)_{\delta=0}$ of Theorem 4.15.

A similar construction can be applied to the Hirota system, written in the three-leg form (6.19). Again, it yields two multiplicative Laplace type equations – on \mathcal{G} and on \mathcal{G}^* . It is instructive to look at the equation on \mathcal{G}^* (for the radii $r_j = w(y_j)$ of the circles):

$$\prod_{j=1}^m \frac{\theta_j r_j - \theta_{j-1} r_0}{\theta_j r_0 - \theta_{j-1} r_j} = 1.$$

Due to eq. (6.17), this equation can be written in terms of the intersection angles ϕ_j of $C(y_0)$ with $C(y_j)$, and takes the form of eq. (6.4). Interestingly, the latter equation holds for *any* circle pattern and is not specific for integrable ones (as opposed to the similar Laplace type equation on \mathcal{G}).

6.4 z^a and $\log z$ circle patterns

Due to the 3D consistency of the cross-ratio and the Hirota systems, we can follow the procedure of Sect. 4.4 and to extend solutions to this systems from a quasicrystalline quad-graph \mathcal{D} , realized as a quad-surface $\Omega_{\mathcal{D}} \subset \mathbb{Z}^d$, to the whole of \mathbb{Z}^d (more precisely, to the hull of $\Omega_{\mathcal{D}}$). Then, one can ask about isomonodromic solutions. As shown in [AgB1, BobHo], this leads to discrete analogs of the power function. Naturally, these discrete power functions are defined on the same branched covering \tilde{S} of the set $\bigcup_{m=1}^{2d} S_m \subset \mathbb{Z}^d$ as the discrete logarithmic function of Sect. 5.5.

Definition 6.12 For $a \in (0, 1)$, the **discrete z^{2a}** is the solution of the discrete cross-ratio system on \tilde{S} defined by the values on the coordinate semi-axes $z_n^{(r)} = z(ne_r)$, $r \in [m, m + d - 1]$, which solve the recurrent relation

$$n \frac{(z_{n+1} - z_n)(z_n - z_{n-1})}{z_{n+1} - z_{n-1}} = az_n. \quad (6.21)$$

with the initial conditions:

$$z_0^{(r)} = z(\mathbf{0}) = 0, \quad z_1^{(r)} = z(e_r) = \theta_r^{2a} = \exp(2a \log \theta_r), \quad (6.22)$$

where $\log \theta_r$ is chosen in the interval (5.26).

By induction, one can derive the following explicit expressions for the solutions $z_n^{(r)}$:

$$z_{2n}^{(r)} = \prod_{k=1}^{n-1} \frac{k+a}{k-a} \cdot \frac{n}{n-a} \cdot \theta_r^{2a}, \quad z_{2n+1}^{(r)} = \prod_{k=1}^n \frac{k+a}{k-a} \cdot \theta_r^{2a}. \quad (6.23)$$

Observe the asymptotic relation

$$z_n^{(r)} = c(a)(n\theta_r)^{2a}(1 + O(n^{-1})). \quad (6.24)$$

The functions z^{2a} correspond to (intersection points and circle centers of) circle patterns. In order to prove this, it is convenient to study the corresponding solutions of the Hirota equation. Therefore, we introduce the functions w^{2a-1} related to z^{2a} by

$$z(\mathbf{n} + \mathbf{e}_j) - z(\mathbf{n}) = \theta_j w(\mathbf{n}) w(\mathbf{n} + \mathbf{e}_j).$$

Definition 6.13 For $a \in (0, 1)$, the **discrete w^{2a-1}** is the solution of the discrete Hirota system on \tilde{S} defined by the values on the coordinate semi-axes $w_n^{(r)} = w(n\mathbf{e}_r)$, $r \in [m, m+d-1]$, which solve the recurrent relation

$$n \frac{w_{n+1} - w_{n-1}}{w_{n+1} + w_{n-1}} = \left(a - \frac{1}{2}\right) (1 - (-1)^n). \quad (6.25)$$

with the initial conditions:

$$w_0^{(r)} = w(\mathbf{0}) = 0, \quad w_1^{(r)} = w(\mathbf{e}_r) = \theta_r^{2a-1} = \exp((2a-1) \log \theta_r), \quad (6.26)$$

where $\log \theta_r$ is chosen in the interval (5.26).

One can easily find a closed expression for $w_n^{(r)}$:

$$w_{2n}^{(r)} = \prod_{k=1}^n \frac{k-1+a}{k-a}, \quad w_{2n+1}^{(r)} = \theta_r^{2a-1}. \quad (6.27)$$

Observe the asymptotics at $n \rightarrow \infty$,

$$w_{2n}^{(r)} = c(a)n^{2a-1}(1 + O(n^{-1})). \quad (6.28)$$

The main technical advantage of the w variables is seen from the following observation.

Theorem 6.14 *The function w^{2a-1} takes values from \mathbb{R}_+ at the white points and values from \mathbb{S}^1 at the black points. Therefore, the function z^{2a} defines a circle pattern.*

Proof. The claim for w^{2a-1} on the coordinate axes is obvious from the explicit formulas (6.27), and can be extended to the whole of \tilde{S} according to the remark after Theorem 6.10. The statement for z^{2a} is now a consequence of Theorem 6.10. \square

The restriction of z^{2a} to various quad-surfaces $\Omega_{\mathcal{D}}$ give the discrete analogs of the power function on the corresponding quasicrystalic quad-graphs \mathcal{D} with the set $\Theta = \{\pm\theta_1, \dots, \pm\theta_d\}$ of edge slopes (see Fig. 6.4).

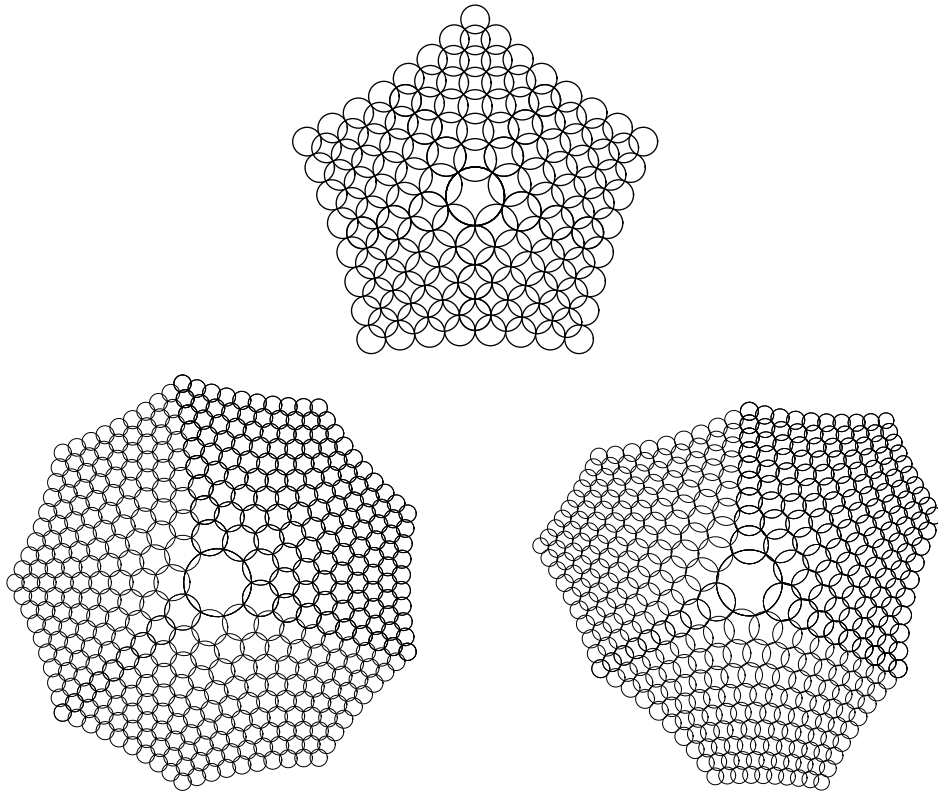

Figure 6.4: Circle patterns $z^{4/5}$ with the combinatorics of the square grid, and $z^{2/3}$ with the combinatorics of the regular hexagonal lattice (isotropic and non-isotropic).

These pictures lead to the conjecture [BobP3] that the circle patterns z^{2a} are embedded, i.e., interiors of different kites are disjoint. This conjecture has been proven in [Ag] for the case of the square grid combinatorics. The fact that the circle patterns z^{2a} are immersed, i.e., the neighboring kites do not overlap, was proven in [AgB1] for the square grid and in [AgB2] for the hexagonal grid combinatorics. One possible approach to the general case could be based on applying the well developed techniques of the theory of isomonodromic solutions [IN] to the asymptotic study of the discrete z^{2a} , because of the following statement.

Theorem 6.15 *The discrete z^{2a} is isomonodromic: for a proper choice of $A(\mathbf{0}; \lambda)$, the matrices $A(\mathbf{n}; \lambda)$ at any point $\mathbf{n} \in (\mathbb{Z}_+)^d$ have simple poles only:*

$$A(\mathbf{n}; \lambda) = \frac{A^{(0)}(\mathbf{n})}{\lambda} + \sum_{l=1}^d \frac{B^{(l)}(\mathbf{n})}{\lambda - \theta_l^{-2}}, \quad (6.29)$$

with

$$A^{(0)}(\mathbf{n}) = \begin{pmatrix} -a/2 & -az(\mathbf{n}) \\ 0 & a/2 \end{pmatrix}, \quad (6.30)$$

$$B^{(l)}(\mathbf{n}) = \frac{n_l}{z(\mathbf{n} + \mathbf{e}_l) - z(\mathbf{n} - \mathbf{e}_l)} \times \begin{pmatrix} z(\mathbf{n} + \mathbf{e}_l) - z(\mathbf{n}) & (z(\mathbf{n} + \mathbf{e}_l) - z(\mathbf{n}))(z(\mathbf{n}) - z(\mathbf{n} - \mathbf{e}_l)) \\ 1 & z(\mathbf{n}) - z(\mathbf{n} - \mathbf{e}_l) \end{pmatrix}. \quad (6.31)$$

At any point $\mathbf{n} \in \tilde{S}$, the discrete z^{2a} satisfies the following constraint:

$$\sum_{j=1}^d n_j \frac{(z(\mathbf{n} + \mathbf{e}_j) - z(\mathbf{n}))(z(\mathbf{n}) - z(\mathbf{n} - \mathbf{e}_j))}{z(\mathbf{n} + \mathbf{e}_j) - z(\mathbf{n} - \mathbf{e}_j)} = az(\mathbf{n}). \quad (6.32)$$

Proof follows the same scheme as the proof of Theorem 5.14: one first shows that the poles of $A(n\mathbf{e}_r; \lambda)$ remain simple, due to the recurrent relations (6.21), and then shows that the order of poles does not increase at the points \mathbf{n} away from the coordinate axes, due to the multidimensional consistency. Note that this scheme works also for Theorem 6.16. \square

The transition between z and w variables is a matter of straightforward computations. Actually, the next theorem is dealing with the same matrices as Theorem 6.15 but written in different variables.

Theorem 6.16 *The discrete w^{2a-1} is isomonodromic: for a proper choice of $A(\mathbf{0}; \lambda)$, the matrices $A(\mathbf{n}; \lambda)$ at any point $\mathbf{n} \in (\mathbb{Z}_+)^d$ have simple poles only:*

$$A(\mathbf{n}; \lambda) = \frac{A^{(0)}(\mathbf{n})}{\lambda} + \sum_{l=1}^d \frac{B^{(l)}(\mathbf{n})}{\lambda - \theta_l^2}, \quad (6.33)$$

with

$$A^{(0)}(\mathbf{n}) = \begin{pmatrix} -a/2 & * \\ 0 & a/2 \end{pmatrix}, \quad (6.34)$$

$$B^{(l)}(\mathbf{n}) = \frac{n_l}{w(\mathbf{n} + \mathbf{e}_l) + w(\mathbf{n} - \mathbf{e}_l)} \begin{pmatrix} w(\mathbf{n} + \mathbf{e}_l) & \theta_l w(\mathbf{n} + \mathbf{e}_l) w(\mathbf{n} - \mathbf{e}_l) \\ 1/\theta_l & w(\mathbf{n} - \mathbf{e}_l) \end{pmatrix}. \quad (6.35)$$

The upper right entry of the matrix $A^{(0)}(\mathbf{n})$, denoted by the asterisk in (6.34), is given by $A_{12}^{(0)}(\mathbf{n}) = -\sum_{l=1}^d B_{12}^{(l)}(\mathbf{n})$. At any point $\mathbf{n} \in \tilde{S}$, the discrete w^{2a-1} satisfies the following constraint:

$$\sum_{l=1}^d n_l \frac{w(\mathbf{n} + \mathbf{e}_l) - w(\mathbf{n} - \mathbf{e}_l)}{w(\mathbf{n} + \mathbf{e}_l) + w(\mathbf{n} - \mathbf{e}_l)} = (a - \frac{1}{2})(1 - (-1)^{n_1 + \dots + n_d}). \quad (6.36)$$

It is interesting to study the limiting behaviour of the function z^{2a} as $a \rightarrow 0$. It is not difficult to see that for all $\mathbf{n} \neq \mathbf{0}$ one has $z^{2a}(\mathbf{n}) \rightarrow 1$. Denote

$$L(\mathbf{n}) = \lim_{a \rightarrow 0} \frac{z^{2a}(\mathbf{n}) - 1}{2a}. \quad (6.37)$$

This function is called the *discrete logarithmic function*; it should not be confused with the namesake function $\ell(\mathbf{n})$ in the linear theory (Sect. 5.5). From eq. (6.37) the following characterization is found: the discrete logarithmic function L is the solution of the discrete cross-ratio system on \tilde{S} defined by the values on the coordinate semi-axes $L_n^{(r)} = L(n\mathbf{e}_r)$, $r \in [m, m + d - 1]$, which solve the recurrent relation

$$n \frac{(L_{n+1} - L_n)(L_n - L_{n-1})}{L_{n+1} - L_{n-1}} = \frac{1}{2} \quad (6.38)$$

with the initial conditions:

$$L_0^{(r)} = L(\mathbf{0}) = \infty, \quad L_1^{(r)} = L(\mathbf{e}_r) = \log \theta_r, \quad (6.39)$$

where $\log \theta_r$ is chosen in the interval (5.26). Explicit expressions:

$$L_{2n}^{(r)} = \log \theta_r + \sum_{k=1}^{n-1} \frac{1}{k} + \frac{1}{2n}, \quad L_{2n+1}^{(r)} = \log \theta_r + \sum_{k=1}^n \frac{1}{k}. \quad (6.40)$$

Theorem 6.17 *The discrete logarithm is isomonodromic and satisfies, at any point $\mathbf{n} \in \tilde{S}$, the following constraint:*

$$\sum_{j=1}^d n_j \frac{(L(\mathbf{n} + \mathbf{e}_j) - L(\mathbf{n}))(L(\mathbf{n}) - L(\mathbf{n} - \mathbf{e}_j))}{L(\mathbf{n} + \mathbf{e}_j) - L(\mathbf{n} - \mathbf{e}_j)} = \frac{1}{2}. \quad (6.41)$$

By restriction to quad-surfaces $\Omega_{\mathcal{D}}$, we come to the discrete logarithmic function on arbitrary quasicrystalline quad-graphs \mathcal{D} . By construction, they all correspond to circle patterns. A conjecture that these circle patterns are embedded seems plausible (see Fig. 6.5).

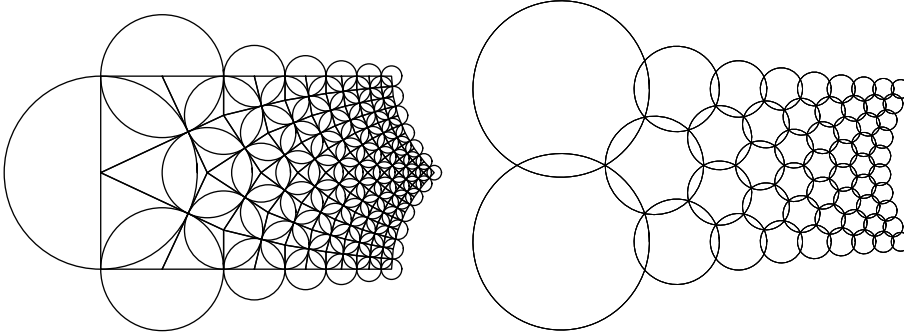

Figure 6.5: Discrete logarithm circle patterns with the combinatorics of the regular square and hexagonal lattices

6.5 Linearization

Let $\theta : \vec{E}(\mathcal{D}) \rightarrow \mathbb{C}$ be an edge labelling, and let $p : V(\mathcal{D}) \rightarrow \mathbb{C}$ be the corresponding parallelogram realization of \mathcal{D} defined by $p(y) - p(x) = \theta(x, y)$. Consider the trivial solutions

$$z_0(x) = p(x), \quad w_0(x) = 1, \quad \forall x \in V(\mathcal{D})$$

of the cross-ratio system (6.9) and the corresponding Hirota system (6.11). Suppose that $z_0 : V(\mathcal{D}) \rightarrow \mathbb{C}$ belongs to a differentiable one-parameter family of solutions $z_\epsilon : V(\mathcal{D}) \rightarrow \mathbb{C}$, $\epsilon \in (-\epsilon_0, \epsilon_0)$, of the same cross-ratio system, and denote by $w_\epsilon : V(\mathcal{D}) \rightarrow \mathbb{C}$ the corresponding solutions of the Hirota system. Denote

$$g = \left. \frac{dz_\epsilon}{d\epsilon} \right|_{\epsilon=0}, \quad f = \left(w_\epsilon^{-1} \frac{dw_\epsilon}{d\epsilon} \right)_{\epsilon=0}. \quad (6.42)$$

Theorem 6.18 *Both functions $f, g : V(\mathcal{D}) \rightarrow \mathbb{C}$ solve discrete Cauchy-Riemann equations (5.16).*

Proof. By differentiating (6.12), we obtain a relation between the functions $f, g : V(\mathcal{D}) \rightarrow \mathbb{C}$:

$$g(y) - g(x) = (f(x) + f(y))(p(y) - p(x)), \quad \forall (x, y) \in \vec{E}(\mathcal{D}). \quad (6.43)$$

The proof of proposition is based on this relation solely. Indeed, the closeness condition for the form on the right-hand side reads:

$$\begin{aligned} & (f(x_0) + f(y_0))(p(y_0) - p(x_0)) + (f(y_0) + f(x_1))(p(x_1) - p(y_0)) + \\ & (f(x_1) + f(y_1))(p(y_1) - p(x_1)) + (f(y_1) + f(x_0))(p(x_0) - p(y_1)) = 0, \end{aligned}$$

which is equivalent to (5.16) for the function f . Similarly, the closeness condition for f , that is,

$$(f(x_0) + f(y_0)) - (f(y_0) + f(x_1)) + (f(x_1) + f(y_1)) - (f(y_1) + f(x_0)) = 0,$$

yields:

$$\frac{g(y_0) - g(x_0)}{p(y_0) - p(x_0)} - \frac{g(x_1) - g(y_0)}{p(x_1) - p(y_0)} + \frac{g(y_1) - g(x_1)}{p(y_1) - p(x_1)} - \frac{g(x_0) - g(y_1)}{p(x_0) - p(y_1)} = 0.$$

Under the condition $p(y_0) - p(x_0) = p(x_1) - p(y_1)$, this is equivalent to (5.16) for g . \square

Remark. This proof shows that, given a discrete holomorphic function $f : V(\mathcal{D}) \rightarrow \mathbb{C}$, relation (6.43) correctly defines a unique, up to an additive constant, function $g : V(\mathcal{D}) \rightarrow \mathbb{C}$, which is also discrete holomorphic. Conversely, for any g satisfying the discrete Cauchy-Riemann equations (5.16), relation (6.43) defines a function f correctly and uniquely (up to an additive black-white constant); this function f also solves the discrete

Cauchy-Riemann equations (5.16). Actually, formula (6.43) expresses that the discrete holomorphic function f is the *discrete derivative* of g , so that g is obtained from f by *discrete integration*. This operation was considered in [Do1, Do2, Me1].

Summarizing, we have the following statement.

Theorem 6.19 *a) A tangent space to the set of solutions of an integrable cross-ratio system, at a point corresponding to a rhombic embedding of a quad-graph, consists of discrete holomorphic functions on this embedding. This holds in both descriptions of the above set: in terms of variables z satisfying the cross-ratio equations, and in terms of variables w satisfying the Hirota equations. The corresponding two descriptions of the tangent space are related by taking the discrete derivative (resp. anti-derivative) of discrete holomorphic functions.*

b) A tangent space to the set of integrable circle patterns of a given combinatorics, at a point corresponding to an isoradial pattern, consists of discrete holomorphic functions on the rhombic embedding of the corresponding quad-graph, which take real values at white vertices and purely imaginary values at black ones. This holds in the description of circle patterns in terms of circle radii and rotation angles at intersection points (Hirota system).

A spectacular instance of this linearization property is delivered by the isomonodromic discrete logarithm studied in Sect. 5.5 and isomonodromic z^{2a} circle patterns of Sect. 6.4.

Theorem 6.20 *The tangent vector to the space of integrable circle patterns along the curve consisting of patterns w^{2a-1} , at the isoradial point corresponding to $a = 1/2$, is the discrete logarithmic function ℓ of Sect. 5.5.*

Proof. We have to prove that the discrete logarithm ℓ and the discrete power function w^{2a-1} are related by

$$\ell(\mathbf{n}) = \left(\frac{1}{2} \frac{d}{da} w^{2a-1}(\mathbf{n}) \right)_{a=1/2}.$$

Due to Theorem 6.18, it is enough to prove this for the initial data on the coordinate semi-axes. But this follows by differentiating with respect to a the initial values (6.27) at the point $a = 1/2$, where all $w = 1$: the result coincides with (5.31). \square

Bibliography

- [Ad] V.E. Adler. Bäcklund transformation for the Krichever-Novikov equation. *Internat. Math. Res. Notices*, 1998, No 1, 1–4.
- [AdBS1] V.E. Adler, A.I. Bobenko, Yu.B. Suris. Classification of integrable equations on quad-graphs. The consistency approach. *Commun. Math. Phys.*, 2003, **233**, 513–543.
- [AdBS2] V.E. Adler, A.I. Bobenko, Yu.B. Suris. Geometry of Yang–Baxter maps: pencils of conics and quadrirational mappings. *Commun. Anal. Geom.*, 2004, **12**, 967–1007.
- [AdS] V.E. Adler, Yu.B. Suris. Q4: Integrable master equation related to an elliptic curves. *Internat. Math. Res. Notices*, 2004, No 47, 2523–2553.
- [AdV] V.E. Adler, A.P. Veselov. Cauchy problem for integrable discrete equations on quad-graphs. *Acta Appl. Math.* **84** (2004), 237–262.
- [Ag] S.I. Agafonov. Imbedded circle patterns with the combinatorics of the square grid and discrete Painlevé equations. *Discrete Comput. Geom.* **29** (2003), 305–319.
- [AgB1] S.I. Agafonov, A.I. Bobenko. Discrete Z^γ and Painlevé equations. *Internat. Math. Res. Notices*, 2000, no. 4, 165–193.
- [AgB2] S.I. Agafonov, A.I. Bobenko. Hexagonal circle patterns with constant intersection angles and discrete Painlevé and Riccati equations. *J. Math. Phys.* **44** (2003), 3455–3469.
- [AkhKV] A.A. Akhmetshin, I.M. Krichever, Y.S. Volvovski. Discrete analogues of the Darboux-Egoroff metrics. *Tr. Mat. Inst. Steklova* **225** (1999), 21–45 (Russian); English translation: *Proc. Steklov Inst. Math.*, **2** (**225**) (1999), 16–39.

- [BeaS] A.F. Beardon, K. Stephenson. The uniformization theorem for circle packings. *Indiana Univ. Math. J.*, 1990, **39**, 1383–1425.
- [Ber] M. Berger. *Geometry*. Berlin etc.: Springer-Verlag, 1987.
- [Bi] L. Bianchi. *Lezioni di geometria differenziale*. 3rd edition. Pisa: Enrico Spoerri, 1923 (Italian). iv+806, xi+832 pp.
- [Bl] W. Blaschke. *Projektive Geometrie*. 3rd edition. Basel etc.: Birkhäuser, 1954. 197 pp.
- [BlIII] W. Blaschke. Vorlesungen über Differentialgeometrie III: Differentialgeometrie der Kreise und Kugeln. Bearbeitet von G. Thomsen. Berlin: Springer, 1929 (German). x+474 pp.
- [Bob] A.I. Bobenko. Discrete conformal maps and surfaces. – In: *SIDE III – Symmetries and integrability of difference equations (Sabaudia, 1998)*, CRM Proc. Lecture Notes, **225** (2000), pp. 97–108.
- [BobHe] A.I. Bobenko, U. Hertrich-Jeromin. Orthogonal nets and Clifford algebras. *Tôhoku Math. Publ.* **20** (2001), 7–22.
- [BobHo] A.I. Bobenko, T. Hoffmann. Hexagonal circle patterns and integrable systems. Patterns with constant angles. *Duke Math. J.* **116:3** (2003) 525–566.
- [BobHoSp] A.I. Bobenko, T. Hoffmann, B.A. Springborn. Discrete minimal surfaces: geometry from combinatorics. *Annals of Math.*, 2005 (to appear).
- [BobHoSu] A.I. Bobenko, T. Hoffmann, Yu.B. Suris. Hexagonal circle patterns and integrable systems: patterns with the multi-ratio property and Lax equations on the regular triangular lattice. *Int. Math. Res. Not.* 2002, no. 3, 111–164.
- [BobMaS1] A.I. Bobenko, D. Matthes, Yu.B. Suris. Nonlinear hyperbolic equations in surface theory: integrable discretizations and approximation results. *Algebra Anal.*, 2005 (to appear).
- [BobMaS2] A.I. Bobenko, D. Matthes, Yu.B. Suris. Discrete and smooth orthogonal systems: C^∞ -approximation. *Int. Math. Res. Not.*, **45** (2003), 2415–2459.

- [BobMeS] A.I. Bobenko, Ch. Mercat, Yu.B. Suris. Linear and nonlinear theories of discrete analytic functions. Integrable structure and isomonodromic Green's function. *J. Reine Angew. Math.*, 2005 (to appear).
- [BobP1] A.I. Bobenko, U. Pinkall. Discrete surfaces with constant negative Gaussian curvature and the Hirota equation. *J. Differential Geom.*, **43** (1996), no. 3, 527–611.
- [BobP2] A.I. Bobenko, U. Pinkall. Discrete isothermic surfaces. *J. Reine Angew. Math.*, **475** (1996), 187–208.
- [BobP3] A.I. Bobenko, U. Pinkall. Discretization of surfaces and integrable systems. – In: *Discrete integrable geometry and physics*, Eds. A.I. Bobenko and R. Seiler, Oxford: Clarendon Press, 1999, pp. 3–58.
- [BobSch1] A.I. Bobenko, W.K. Schief. Discrete indefinite affine spheres. – In: *Discrete integrable geometry and physics*, Eds. A.I. Bobenko and R. Seiler, Oxford: Clarendon Press, 1999, pp. 113–138.
- [BobSch2] A.I. Bobenko, W.K. Schief. Affine spheres: discretization via duality relations. *Experiment. Math.*, **8** (1999), 261–280.
- [BobSp] A.I. Bobenko, B.A. Springborn. Variational principles for circle patterns and Koebe's theorem. *Trans. Amer. Math. Soc.* **356** (2004), 659–689.
- [BobSu1] A.I. Bobenko, Yu.B. Suris. Integrable systems on quad-graphs. *Internat. Math. Res. Notices*, 2002, Nr. 11, 573–611.
- [BobSu2] A.I. Bobenko, Yu.B. Suris. Integrable noncommutative equations on quad-graphs. The consistency approach. *Lett. Math. Phys.*, 2002, **61**, 241–254.
- [BogK] L.V. Bogdanov, B.G. Konopelchenko. Lattice and q -difference Darboux-Zakharov-Manakov systems via $\bar{\partial}$ -dressing method. *J. Phys. A*, **28** (1995), L173–L178.
- [CDS] J. Cieslinski, A. Doliwa, P.M. Santini. The integrable discrete analogues of orthogonal coordinate systems are multi-dimensional circular lattices. *Phys. Lett. A* **235** (1997), 480–488.

- [Da1] G. Darboux. *Leçons sur la théorie générale des surfaces et les applications géométriques du calcul infinitésimal*. T.I–IV. 3rd edition. Paris: Gauthier-Villars, 1914–1927. (French)
- [Da2] G. Darboux. *Leçons sur les systèmes orthogonaux et les coordonnées curvilignes*. 2nd edition. Paris: Gauthier-Villars, 1910. vii+567 pp.
- [DoSh1] N.P. Dolbilin, M.A. Shtan’ko, M.I. Shtogrin. Cubic subcomplexes in regular lattices. (Russian) *Dokl. Akad. Nauk SSSR* **291** (1986), 277–279.
- [DoSh2] N.P. Dolbilin, M.A. Shtan’ko, M.I. Shtogrin. Cubic manifolds in lattices. (Russian) *Izv. Ross. Akad. Nauk Ser. Mat.*, **58** (1994), 93–107; english translation in: *Russian Acad. Sci. Izv. Math.* **44** (1995), 301–313.
- [Do1] A. Doliwa. Geometric discretization of the Toda system. *Phys. Lett. A* **234** (1997), 187–192.
- [Do2] A. Doliwa. Quadratic reductions of quadrilateral lattices. *J. Geom. Phys.* **30** (1999), 169–186.
- [Do3] A. Doliwa. Lattice geometry of the Hirota equation. In: *SIDE III – Symmetries and integrability of difference equations (Sabaudia, 1998)*, CRM Proc. Lecture Notes, **225** (2000), pp. 93–100.
- [Do4] A. Doliwa. Discrete asymptotic nets and W -congruences in Plücker line geometry. *J. Geom. Phys.* **39** (2001), no. 1, 9–29.
- [Do5] A. Doliwa. Geometric discretization of the Koenigs nets. *J. Math. Phys.* **44** (2003), 2234–2249.
- [DoMS] A. Doliwa, S.V. Manakov, P.M. Santini. $\bar{\partial}$ -reductions of the multidimensional quadrilateral lattice. The multidimensional circular lattice. *Commun. Math. Phys.* **196** (1998), 1–18.
- [DoNS1] A. Doliwa, M. Nieszporski, P.M. Santini. Asymptotic lattices and their integrable reductions. I. The Bianchi-Ernst and the Fubini-Ragazzi lattices. *J. Phys. A* **34** (2001), 10423–10439.
- [DoNS2] A. Doliwa, M. Nieszporski, P.M. Santini. Geometric discretization of the Bianchi system. *J. Geom. Phys.* **52** (2004), 217–240.

- [DoS1] A. Doliwa, P.M. Santini. Multidimensional quadrilateral lattices are integrable. *Phys. Lett. A*, **233** (1997), 265–372.
- [DoS2] A. Doliwa, P.M. Santini. The symmetric, d -invariant and Egorov reductions of the quadrilateral lattice. *J. Geom. Phys.* **36** (2000), 60–102.
- [DoSM] A. Doliwa, P.M. Santini, M. Mañas. Transformations of quadrilateral lattices. *J. Math. Phys.* **41** (2000), 944–990.
- [DoGNS] A. Doliwa, P. Grinevich, M. Nieszporski, P.M. Santini. Integrable lattices and their sub-lattices: from the discrete Moutard (discrete Cauchy-Riemann) 4-point equation to the self-adjoint 5-point scheme. *Preprint* <http://arxiv.org/abs/nlin.SI/0410046>.
- [Dr] V.G. Drinfeld. On some unsolved problems in quantum group theory. *Lecture Notes Math.*, 1992, **1510**, 1–8.
- [Du1] R.J. Duffin. Basic properties of discrete analytic functions. *Duke Math. J.*, 1956, **23**, 335–363.
- [Du2] R.J. Duffin. Potential theory on a rhombic lattice. *J. Combinatorial Theory*, 1968, **5**, 258–272.
- [DyN] I.A. Dynnikov, S.P. Novikov. Geometry of the triangle equation on two-manifolds. *Mosc. Math. J.* **3** (2003), 419–438.
- [E1] L.P. Eisenhart. *A treatise on the differential geometry of curves and surfaces*. Boston: Ginn and Co., 1909. ix+379 pp.
- [E2] L.P. Eisenhart. *Transformations of surfaces*. Princeton University Press, 1923. ix+379 pp.
- [F] J. Ferrand. Fonctions preharmoniques et fonctions preholomorphes. *Bull. Sci. Math.*, 2nd ser., 1944, **68**, 152–180.
- [GT] E.I. Ganzha, S.P. Tsarev. An algebraic superposition formula and the completeness of Bäcklund transformations of $(2 + 1)$ -dimensional integrable systems. *Uspekhi Mat. Nauk* **51** (1996), no. 6, 197–198 (Russian); English translation in: *Russian Math. Surveys* **51** (1996), 1200–1202.
- [He] Z.-X. He. Rigidity of infinite disk patterns. *Ann. of Math.*, 1999, **149**, p. 1–33.

- [HeS] Z.-X. He, O. Schramm. The C^∞ convergence of hexagonal disc packings to Riemann map. *Acta Math.*, 1998, **180**, 219–245.
- [He1] U. Hertrich-Jeromin. Transformations of discrete isothermic nets and discrete cmc-1 surfaces in hyperbolic space. *Manuscr. Math.* **102** (2000), 465–486.
- [He2] U. Hertrich-Jeromin. *Introduction to Möbius differential geometry*. Cambridge University Press, 2003. xii+413 pp.
- [HeHP] U. Hertrich-Jeromin, T. Hoffmann, U. Pinkall. A discrete version of the Darboux transform for isothermic surfaces. – In: *Discrete integrable geometry and physics*, Eds. A.I. Bobenko and R. Seiler, Oxford: Clarendon Press, 1999, pp. 59–81.
- [HeMNP] U. Hertrich-Jeromin, I. McIntosh, P. Norman, F. Pedit. Periodic discrete conformal maps. *J. Reine Angew. Math.* **534** (2001), 129–153.
- [Hi] R. Hirota. Nonlinear partial difference equations. I. A difference analog of the Korteweg–de Vries equation. III. Discrete sine-Gordon equation. *J. Phys. Soc. Japan*, 1977, **43**, 1423–1433, 2079–2086.
- [Ho] T. Hoffmann. Darboux transformation for S-isothermic surfaces. *In preparation*.
- [IN] A. Its, V. Novokshenov. The isomonodromic deformation method in the theory of Painlevé equations. *Lecture Notes Math.*, **1191**, 313 pp. Berlin: Springer, 1986.
- [J] H. Jonas. Über die Transformation der konjugierten systeme und über den gemeinsamen Ursprung der Bianchischen Permutabilitätstheoreme. *Sitzungsber. Berl. Math. Ges.*, 1915, **14**, 96–118.
- [Ke] R. Kenyon. The Laplacian and Dirac operators on critical planar graphs. *Invent. Math.*, 2002, **150**, 409–439.
- [KeS] R. Kenyon, J.-M. Schlenker. Rhombic embeddings of planar graphs with faces of degree 4. *Trans. AMS*, 2004 (to appear).
- [KoP] B. Konopelchenko, U. Pinkall. Projective generalizations of Lelievre’s formula. *Geom. Dedicata* **79** (2000), 81–99.

- [KoSch] B.G. Konopelchenko, W.K. Schief. Three-dimensional integrable lattices in Euclidean spaces: conjugacy and orthogonality. *R. Soc. Lond. Proc. Ser. A*, **454** (1998), 3075–3104.
- [Kor] V.E. Korepin. Completely integrable models in quasicrystals. *Commun. Math. Phys.* **110** (1987), 157–171.
- [Kr] I.M. Krichever. Algebraic-geometric n-orthogonal curvilinear coordinate systems and the solution of associativity equations. *Funct. Anal. Appl.*, **31** (1997), 25–39.
- [MDS] M. Mañas, A. Doliwa, P.M. Santini. Darboux transformations for multidimensional quadrilateral lattices. *Phys. Lett. A*, **232** (1997), 99–105.
- [MR] A. Marden, B. Rodin. On Thurston’s formulation and proof of Andreev’s theorem. *Lect. Notes Math.*, 1990, **1435**, 103–115.
- [MPS] R.R. Martin, J. de Pont, T.J. Sharrock. Cyclide surfaces in computer aided design. In: *The mathematics of surfaces*, Ed. J.A. Gregory, Oxford: Clarendon Press, 1986, pp.253–268.
- [Me1] Ch. Mercat. Discrete Riemann surfaces and the Ising model. *Commun. Math. Phys.*, 2001, **218**, 177–216.
- [Me2] Ch. Mercat. Exponentials form a basis of discrete holomorphic functions. *Bull. Soc. Math. France* **132** (2004) 305–326.
- [Mou] Th.F. Moutard. Sur la construction des équations de la forme $\frac{1}{z} \frac{\partial^2 z}{\partial x \partial y} = \lambda(x, y)$ qui admettent une intégrale générale explicite. *J. Éc. Pol.* **45** (1878), 1–11.
- [Mö] A.F. Möbius. Kann von zwei dreiseitigen Pyramiden eine jede in Bezug auf andere um- und eingeschrieben zugleich heissen? *J. Reine und Angew. Math.*, **3** (1828), 273–278.
- [Nie] M. Nieszporski. On a discretization of asymptotic nets. *J. Geom. Phys.* **40** (2002), 259–276.
- [NieSD] M. Nieszporski, P.M. Santini, A. Doliwa. Darboux transformations for 5-point and 7-point self-adjoint schemes and an integrable discretization of the 2D Schrödinger operator. *Phys. Lett. A*, **323** (2004), 241–250.

- [Nij] F.W. Nijhoff. Lax pair for the Adler (lattice Krichever-Novikov) system. *Phys. Lett. A* **297** (2002), 49–58.
- [NijC] F.W. Nijhoff, H.W. Capel. The discrete Korteweg-de Vries equation. *Acta Appl. Math.* **39** (1995) 133–158.
- [NiSch] J.J.C. Nimmo, W.K. Schief. Superposition principles associated with the Moutard transformation: an integrable discretization of a $(2 + 1)$ -dimensional sine-Gordon system. *Proc. Roy. Soc. London Ser. A* **453** (1997), 255–279.
- [No1] S.P. Novikov. Schrödinger operators on graphs and symplectic geometry. In: *The Arnoldfest*, Fields Inst. Commun., 24, Providence: AMS, 1999, 397–413.
- [No2] S.P. Novikov. The discrete Schrödinger operator. *Tr. Mat. Inst. Steklova* **224** (1999) 275–290 (Russian); English translation: *Proc. Steklov Inst. Math.* **224** (1999) 250–265.
- [NoD] S.P. Novikov, I.A. Dynnikov. Discrete spectral symmetries of small-dimensional differential operators and difference operators on regular lattices and two-dimensional manifolds. *Uspekhi Mat. Nauk* **52** (1997), no. 5(317), 175–234 (Russian); English translation: *Russian Math. Surveys* **52** (1997), 1057–1116.
- [Nu] A.W. Nutbourne. The solution of frame matching equation. In: *The mathematics of surfaces*, Ed. J.A. Gregory, Oxford: Clarendon Press, 1986, pp.233–252.
- [QNCL] G.R.W. Quispel, F.W. Nijhoff, H.W. Capel, J. van der Linden. Linear integral equations and nonlinear difference-difference equations. *Physica A*, 1984, **125**, 344–380.
- [RSch] C. Rogers, W.K. Schief. *Bäcklund and Darboux transformations. Geometry and modern applications in soliton theory*. Cambridge University Press, 2002, xviii+413 pp.
- [RSu] B. Rodin, D. Sullivan. The convergence of circle packings to Riemann mapping. *J. Diff. Geom.*, 1987, **26**, 349–360.
- [Sa] R. Sauer. *Differenzgeometrie*. Berlin etc.: Springer, 1970, 234 pp.

- [Sch1] W.K. Schief. Isothermic surfaces in spaces of arbitrary dimension: integrability, discretization and Bäcklund transformations. A discrete Calapso equation. *Stud. Appl. Math.*, **106** (2001), 85–137.
- [Sch2] W.K. Schief. On the unification of classical and novel integrable surfaces. II. Difference geometry. *R. Soc. Lond. Proc. Ser. A* **459** (2003), 373–391.
- [Schr] O. Schramm. Circle patterns with the combinatorics of the square grid. *Duke Math. J.*, 1997, **86**, p. 347–389.
- [ShSh] M.A. Shtan'ko, M.I. Shtogrin. Embedding cubic manifolds and complexes into a cubic lattice. *Uspekhi Mat. Nauk* **47** (1992), no. 1 (283), 219–220 (Russian); English translation: *Russian Math. Surveys* **47** (1992), 267–268.
- [St1] K. Stephenson. Circle packing: a mathematical tale. *Notices Amer. Math. Soc.* **50** (2003), 1376–1388.
- [St2] K. Stephenson. *Introduction to the theory of circle packing: discrete analytic functions*. Cambridge Univ. Press, 2005. 400 pp.
- [SuV] Yu.B. Suris, A.P. Veselov. Lax matrices for Yang-Baxter maps. *J. Nonlinear Math. Phys.*, **10**, suppl. **2** (2003), 223–230.
- [Th1] W.P. Thurston. The finite Riemann mapping theorem. *Invited talk at the international symposium on the occasion of the proof of the Bieberbach conjecture*, Purdue University, 1985.
- [Th2] W.P. Thurston. *Three-dimensional geometry and topology. Vol. 1*, Princeton Univ. Press, 1997. x+311 pp.
- [Tzi] G. Tzitzéica. *Géométrie différentielle projective des réseaux*. Bucharest: Cultura Nationala, 1924.
- [V] A.P. Veselov. Yang-Baxter maps and integrable dynamics. *Phys. Lett. A*, **314** (2003), 214–221.
- [W] W. Wunderlich. Zur Differenzengeometrie der Flächen konstanter negativer Krümmung. *Österreich. Akad. Wiss. Math.-Nat. Kl.*, **160** (1951), 39–77.
- [Z] V.E. Zakharov. *What is integrability?* Berlin: Springer, 1991.